



F.B.
SUBMERSIBLE MOTORS

WATER OUR PASSION... **SINCE 1991**

SUBMERSIBLE MOTORS



CATALOGO ELETTROPOMPE 6 - 2016



QUALITÀ NEL POZZO

F.B. srl è presente sul mercato delle elettropompe sommerse da 25 anni offrendo alla clientela competenza, professionalità e prodotti di estrema qualità ed affidabilità.

Per farVi risparmiare tempo e denaro abbiamo studiato, ricercato e realizzato una gamma completa di elettropompe sommerse da 4" a 12" e relativi accessori per il Vostro impianto di approvvigionamento idrico qualsiasi sia l'utilizzo. Dall'irrigazione in generale all'impiego dell'acqua potabile, dalle applicazioni civili e industriali agli impianti antincendio, in ogni luogo, dove serve rilanciare e distribuire l'acqua.

Le nostre elettropompe sono consigliate per pompare acqua pulita con contenuto di sabbia
fino a 150 g/m³ per le elettropompe 4"
fino a 100 g/m³ per le elettropompe da 6" a 12"
utilizzabili per pozzi profondi fino a 840 m e con portate massime fino a 8500 l/m.

ACCESSORI

È statisticamente provato che il 95% dei problemi riscontrati sull'installazione delle elettropompe sono dovuti alla mancanza dei complementi adeguati. Gli accessori che Vi proponiamo, come quadri elettrici, cavi, giunzioni, materiale per il sostegno dell'elettropompa, sono cose semplici ma non da sottovalutare, scelti per Voi per darVi una maggiore sicurezza e tranquillità nel tempo.



QUALITY INSIDE THE WELL

F.B. srl is on the market of submersible electropumps for 25 years offering the customers expertise, professionalism and high-quality, reliable products.

To make you saving money we have studied, researched and realised a full range of electropumps from 4" to 12" and accessories for your water supply system for any kind of employment: from general irrigation to drinking water, from civil and industrial application to firefighting systems and in general, where is necessary throw again and supply water. Our electropumps are highly recommended to pump clean water with sand content

up to 150 g/m³ for 4" electropumps

up to 100 g/m³ for the electropumps from 6" to 12"

suitable for wells deep up to 840 m with maximum capacity up to 8500 l/m.

ACCESSORIES

It has been proved that 95% of the problems had with the installation of pumps are due to the lack of adequate accessories. The accessories we recommend, such as control boxes, cables, junction and materials for the support of the pumps, are chosen in order to give you higher confidence and reliability.



QUALITÉ DANS LE PUIT

La société F.B. Srl est présente sur le marché des électropompes immergées de 25 ans en offrant à la clientèle compétence, professionnalisme et produits d'extrême qualité et fiabilité.

Pour Vous faire gagner du temps et de l'argent nous avons étudié, recherché et réalisé une complète gamme des électropompes immergées de 4" à 12" et des accessoires pour votre installation d'approvisionnement hydrique quel soit l'utilise. De l'irrigation en général à l'emploi de l'eau potable, des applications civiles et industrielles aux installations contre les incendies, dans chaque lieu où il est nécessaire de relancer et distribuer l'eau.

Nôtres électropompes sont conseillées pour pomper eau propre avec contenue de sable

jusqu'à 150 g/m³ pour les électropompes de 4"

jusqu'à 100 g/m³ pour les électropompes de 6" à 12"

utilisables pour des puits profonds jusqu'à 700 m avec des débits maximes jusqu'à 8500 l/m.

ACCESSOIRES

Il est statistiquement éprouvé que le 95% des problèmes relevés sur l'installation des électropompes sont dû au manque des composantes adéquates.

Les accessoires que nous vous proposons, comme coffrets électriques, câbles, jonctions, matériel pour le soutien de l'électropompe, sont des choses simples mais jamais à sous-estimer, choisis pour vous donner une majeure sûreté et une tranquillité dans le temps.

SUBMERSIBLE MOTORS



Vicenza

100% MADE IN ITALY



CERTIFIED ISO 9001:2008

water our passion...
since 1991





SUBMERSIBLE MOTORS



SUBMERSIBLE MOTORS



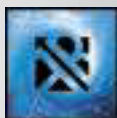

- 1 Elettropompa sommersa**
Submersible electropump
Électropompe immergée
- 2 Quadro elettrico**
Control panel
Coffret électrique
- 3 Saracinesca di regolazione portata**
Gate valve
Vanne de réglage du débit
- 4 Manometro**
Pressure gauge
Manomètre
- 5 Valvola di ritegno**
Non-return valve
Clapet anti-retour
- 6 Sonda controllo livello**
Level probes
Sonde de niveau
- 7 Filtri del pozzo**
Well strainers
Filtres du puits
- 8 Cavo di alimentazione**
Power supply cable
Câble d'alimentation
- 9 Fascette fissaggio cavi**
Cable clips
Collier de fixation du câble
- 10 Testa stagna**
Watertight head
Tête de forage étanche
- 11 Tubazione di mandata**
Delivery pipe
Tuyau de refoulement
- 12 Camicia di raffreddamento**
Cooling sleeve
Chemise de refroidissement
- 13 Staffe di sospensione**
Pipe clamps
Brides de suspensions

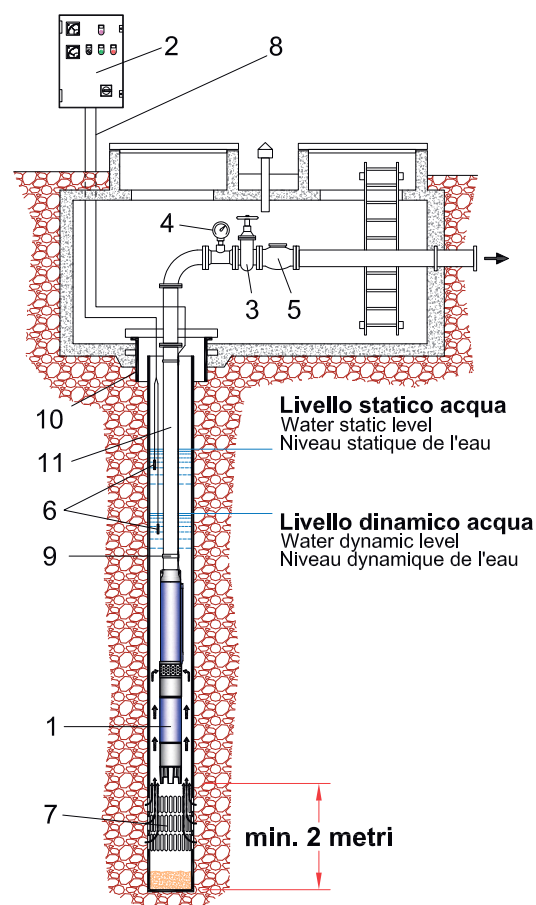

APPLICAZIONI

APPLICATIONS
APPLICATIONS



AGRICOLTURA
AGRICULTURE
AGRICULTURE



INDUSTRIA
INDUSTRY
INDUSTRIE



CIVILE
CIVIL
CIVIL



APPROVVIGIONAMENTO IDRICO
WATER SUPPLY SYSTEM
INSTALLATION D'APPROVISIONNEMENT HYDRIQUE

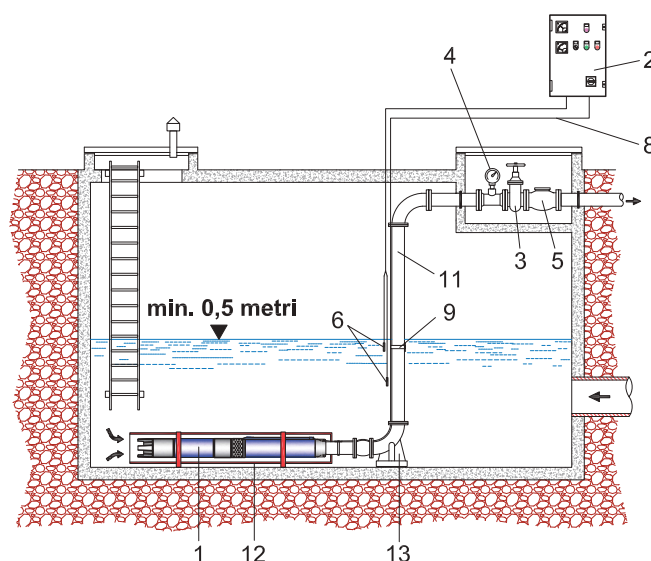

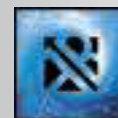

ELETTROPOMPE SOMMERSE 4" TIPO FB4
4" SUBMERSIBLE ELECTROPUMPS TYPE FB4
ÉLECTROPOMPES IMMERGÉES 4" TYPE FB4

8

ELETTROPOMPE SOMMERSE 6" TIPO FB6R
6" SUBMERSIBLE ELECTROPUMPS TYPE FB6R
ÉLECTROPOMPES IMMERGÉES 6" TYPE FB6R

28

ELETTROPOMPE SOMMERSE RADIALI 6" TIPO FB6R14
6" RADIAL-FLOW SUBMERSIBLE ELECTROPUMPS TYPE FB6R14
ÉLECTROPOMPES IMMERGÉES RADIALES 6" TYPE FB6R14

44

ELETTROPOMPE SOMMERSE SEMIASSIALI 6" TIPO FB6S
6" MIXED-FLOW SUBMERSIBLE ELECTROPUMPS TYPE FB6S
ÉLECTROPOMPES IMMERGÉES SEMI-AXIALES 6" TYPE FB6S

54

ELETTROPOMPE SOMMERSE RADIALI 6" TIPO FB6RX
6" RADIAL-FLOW SUBMERSIBLE ELECTROPUMPS TYPE FB6RX
ÉLECTROPOMPES IMMERGÉES RADIALES 6" TYPE FB6RX

68

ELETTROPOMPE SOMMERSE SEMIASSIALI 6" TIPO FB6SX
6" MIXED-FLOW SUBMERSIBLE ELECTROPUMPS TYPE FB6SX
ÉLECTROPOMPES IMMERGÉES SEMI-AXIALES 6" TYPE FB6SX

90

ELETTROPOMPE SOMMERSE RADIALI 8" TIPO FB8R
8" RADIAL-FLOW SUBMERSIBLE ELECTROPUMPS TYPE FB8R
ÉLECTROPOMPES IMMERGÉES RADIALES 8" TYPE FB8R

110

ELETTROPOMPE SOMMERSE SEMIASSIALI 8" TIPO FB8S
8" MIXED-FLOW SUBMERSIBLE ELECTROPUMPS TYPE FB8S
ÉLECTROPOMPES IMMERGÉES SEMI-AXIALES 8" TYPE FB8S

120

ELETTROPOMPE SOMMERSE SEMIASSIALI 8" TIPO FB8SX
8" MIXED-FLOW SUBMERSIBLE ELECTROPUMPS TYPE FB8SX
ÉLECTROPOMPES IMMERGÉES SEMI-AXIALES 8" TYPE FB8SX

134

ELETTROPOMPE SOMMERSE RADIALI 10" TIPO FB10R
10" RADIAL-FLOW SUBMERSIBLE ELECTROPUMPS TYPE FB10R
ÉLECTROPOMPES IMMERGÉES RADIALES 10" TYPE FB10R

144

ELETTROPOMPE SOMMERSE SEMIASSIALI 10" TIPO FB10S
10" MIXED-FLOW SUBMERSIBLE ELECTROPUMPS TYPE FB10S
ÉLECTROPOMPES IMMERGÉES SEMI-AXIALES 10" TYPE FB10S

152

ELETTROPOMPE SOMMERSE SEMIASSIALI 12" TIPO FB12S
12" MIXED-FLOW SUBMERSIBLE ELECTROPUMPS TYPE FB12S
ÉLECTROPOMPES IMMERGÉES SEMI-AXIALES 12" TYPE FB12S

166

ELETTROPOMPE SOMMERSE 5"
5" SUBMERSIBLE ELECTROPUMPS
ÉLECTROPOMPES IMMERGÉES 5"

180

QUADRI ELETTRICI
CONTROL PANELS
COFFRETS ÉLECTRIQUES

184

ACCESSORI
ACCESSORIES
ACCESSOIRES

198

DIMENSIONAMENTO DEI CAVI
MEASURING OF THE CABLES
DIMENSIONNEMENT DES CÂBLES

215

SCelta DEL GENERATORE
GENERATOR SELECTION
CHOIX DU GÉNÉRATEUR

219

TABELLA PERDITE DI CARICO NELLE TUBAZIONI
HEAD LOSS IN PIPES CHART
TABLEAU PERTES DE CHARGE DANS LES TUYAUX

220

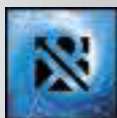

ELETTROPOMPE SOMMERSE 4" CON GIRANTI FLOTTANTI

4" SUBMERSIBLE ELECTROPUMPS WITH FLOATING IMPELLERS
ÉLECTROPOMPES IMMERGÉES 4" AVEC ROUE DE TYPE FLOTTANTE



Le elettropompe sommerse 4" serie FB4 sono per acque pulite per pozzi 4" DN100.

La straordinaria semplicità nella costruzione, le prestazioni date dalle giranti flottanti antiusura e la facile installazione, garantiscono un prodotto di alta qualità, duraturo nel tempo.

APPLICAZIONI:

- irrigazione
- approvvigionamento idrico
- aumento pressione
- antincendio

COSTRUZIONE:

- supporti superiore ed inferiore in acciaio inox microfuso AISI 304
- bocca di mandata in acciaio inox microfuso AISI 304
- valvola di non ritorno in acciaio inox AISI 304
- camicia esterna in acciaio inox AISI 304
- albero in acciaio inox AISI 304
- copri cavo in acciaio inox AISI 304
- giranti flottanti in tecnopolimero (noryl)

CARATTERISTICHE:

- portata massima: 400 l/m
- prevalenza massima: 392 metri
- potenza massima: 7,5 Kw
- diametro d'ingombro massimo: 98 mm (incluso il copri cavo)
- temperatura massima dell'acqua: 35°C (solo per la pompa, per il motore vedi catalogo motori)
- contenuto di sabbia massimo: 150 g/m³



Les électropompes immergées de la série FB4 sont pour eaux propres pour puits 4" DN100.

L'extraordinaire simplicité dans la construction, les prestations données par les roues flottantes anti usure, la facile installation garantissent un produit de haute qualité, durable dans le temps.

APPLICATIONS:

- irrigation
- installation d'approvisionnement hydrique
- surpression
- anti incendie

CONSTRUCTION:

- supports supérieur et inférieur en acier inoxydable micro fondu AISI 304
- bouche de refoulement en acier inoxydable micro fondu AISI 304
- clapet de retenue en acier inoxydable AISI 304
- chemise extérieure en acier inoxydable AISI 304
- arbre en acier inoxydable AISI 304
- couvre-câble en acier inoxydable AISI 304
- roues flottantes en noryl

CARACTÉRISTIQUES:

- débit maximum: 400 l/m
- hauteur maximale: 392 mètres
- puissance maximale: 7,5 Kw
- diamètre d'encombrement maximum: 98 mm (inclus le couvre-câble)
- température maximale de l'eau: 35°C (pour la pompe, pour le moteur voir le catalogue des moteurs)
- quantité maximale de sable: 150 g/m³



4" submersible pumps, range FB4, are for clean water for 4" wells DN 100.

The extraordinary simplicity in the construction, the performances given from anti wear floating impellers and the easy installation guarantee a high quality product, long-lasting in the time.

APPLICATIONS:

- irrigation
- water supply system
- pressure boosting
- fire-fighting systems

CONSTRUCTION:

- micro-cast stainless steel AISI 304 upper and lower support
- micro-cast stainless steel AISI 304 delivery bowl
- stainless steel AISI 304 non return valve
- stainless steel AISI 304 external sleeve
- stainless steel AISI 304 shaft
- stainless steel AISI 304 cable cover

FEATURES:

- maximum capacity: 400 l/m
- maximum head: 392 meters
- maximum power: 7,5 Kw
- maximum encumbrance diameter: 98 mm (cable cover included)
- maximum water temperature: 35°C (only for the pump, for the motor see motors' catalogue)
- maximum sand content: 150 g/m³



SPACCATO 4"

4" CUTAWAY
COUPE 4"

FB4

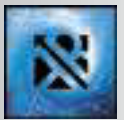

N°	Descrizione Description Description	Materiale Material Material
1	Supporto di aspirazione Suction Support Support d'Aspiration	AISI 304
2	Giunto di Traino Joint Joint	AISI 304
3	Succheruola Suction Strainer Crepine	AISI 304
4	Distanziale prima girante Spacer first impeller Entretoise première roue	Noryl GFN2
5	Vite Screw Vis	AISI 304
6	Spessore Thickness Epaisseur	AISI 304
7	Albero pompa Pump Shaft Axe Pompe	AISI 304
8	Camicia Sleeve Chemise	AISI 304
9	Copri cavo Cable cover Protection Capot	AISI 304
10	Elemento intermedio Intermediate Casting Élément Intermédiaire	AISI 304
11	Girante Impeller Roue	Noryl GFN2
12	Diffusore Diffuser Diffuser	Noryl GFN2
13	Seeger Seeger	AISI 304
14	Rondella Washer Rondelle	AISI 304
15	Distanziatore intermedio Intermediate Spacer Entretoise intermédiaire	Acciaio Sinterizzato Sintered Steel Fonte Agglomérée
16	Supporto superiore Superior support Support supérieur	Noryl GFN2
17	Rondella Washer Rondelle	AISI 304
18	Vite Screw Vis	AISI 304
19	Anello elastico Seeger ring Anneau seeger	AISI 304
20	Anello tenuta OR O.R. ring Bague O.R.	Gomma Rubber Caoutchouc
21	Coperchio Cover Couvercle	AISI 304
22	Guarnizione farfalla Upper Ring Bague Supérieure	Elastomero EPDM EPDM Elastomer
23	Farfalla Cap Valve Piat	AISI 304
24	Mandata Delivery Bow Rebutement	AISI 304

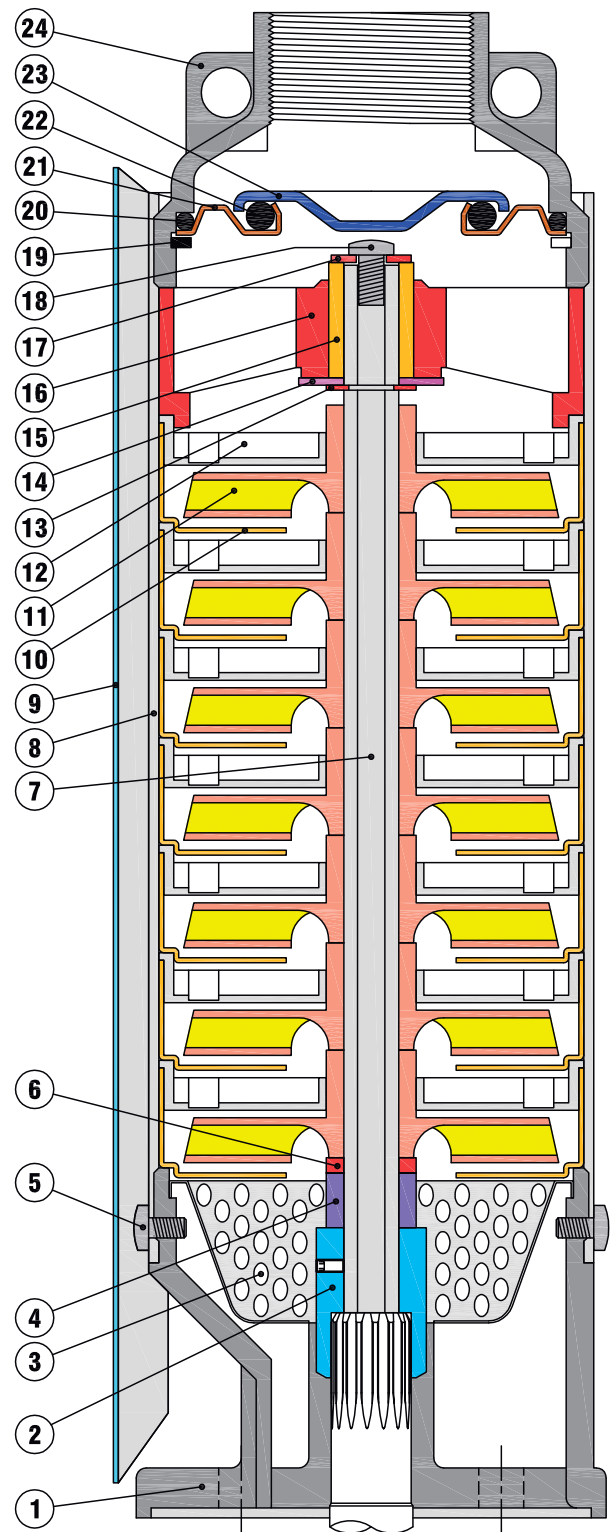



TABELLA DELLE CARATTERISTICHE IDRAULICHE 4"

4" HYDRAULIC FEATURES' CHART

TABLE DES CARACTÉRISTIQUES HYDRAULIQUES 4"

Tipo Type Type	Motore Motor Moteur		Q = Portata - Capacity - Débit																				
			l/sec	0	0,08	0,17	0,25	0,33	0,42	0,5	0,6	0,67	0,75	0,83	1	1,17	1,33	1,5	1,67	2	2,33		
			l/min	0	5	10	15	20	25	30	35	40	45	50	60	70	80	90	100	120	140		
			mc/h	0	0,3	0,6	0,9	1,2	1,5	1,8	2,1	2,4	2,7	3	3,6	4,2	4,8	5,4	6	7,2	8,4		
FB4-0513	0,5	0,37	H(m)	86	78	70	56	42	23														
FB4-0519	0,75	0,55		126	118	105	86	60	30														
FB4-0526	1	0,75		173	160	141	117	81	39														
FB4-0538	1,5	1,1		253	234	208	169	117	52														
FB4X-0550	2	1,5		283	271	246	199	140	73														
FB4-1007	0,5	0,37	H(m)	46			43	42	39	36	33	29	26	22									
FB4-1010	0,75	0,55		69			65	63	60	55	50	44	37	29									
FB4-1014	1	0,75		92			86	83	79	74	67	60	52	42									
FB4-1020	1,5	1,1		139			131	127	120	111	101	90	75	60									
FB4-1028	2	1,5		189			178	172	164	153	140	126	108	90									
FB4-1040	3	2,2		265			247	237	224	208	189	170	147	120									
FB4X-1065	4	3		376			336	320	285	245	201	153	82	29									
FB4-1305	0,5	0,37		H(m)	34				32	31	30	29	28	26	24	19	13						
FB4-1308	0,75	0,55	54					51	50	49	46	43	41	38	30	19							
FB4-1311	1	0,75	72					68	66	64	61	58	54	49	38	26							
FB4-1316	1,5	1,1	106					101	98	95	89	83	77	70	54	33							
FB4-1321	2	1,5	142					135	132	127	122	115	108	100	79	49							
FB4-1332	3	2,2	208					200	194	187	177	165	152	138	104	62							
FB4X-1345	4	3	288					269	250	243	233	224	211	199	162	110							
FB4X-1360	5,5	4	392					350	336	325	312	297	278	260	210	143							
FB4-1805	0,5	0,37	H(m)		33						28	27	26	25	24	21	18	13	8	3			
FB4-1807	0,75	0,55		46							42	41	40	39	37	33	28	21	13	7			
FB4-1809	1	0,75		59							54	52	51	49	47	43	37	28	20	10			
FB4-1814	1,5	1,1		93							86	83	81	79	76	68	58	47	33	20			
FB4-1818	2	1,5		120							111	108	105	102	98	88	75	60	42	25			
FB4-1827	3	2,2		175							161	157	152	147	141	127	109	87	61	35			
FB4-1835	4	3		231							212	208	202	196	189	170	149	120	87	50			
FB4-1848	5,5	4		322							292	285	276	267	256	231	199	160	118	70			
FB4X-1860	7,5	5,5		380							338	331	323	316	309	288	273	250	222	195			
FB4-3507	1	0,75		H(m)	42											36	34	32	30	28	25	19	11
FB4-3510	1,5	1,1	62													53	51	48	45	41	38	29	18
FB4-3514	2	1,5	90													77	74	71	68	63	59	46	28
FB4-3520	3	2,2	125													107	102	97	92	86	80	62	40
FB4-3527	4	3	169													145	139	131	123	115	107	84	55
FB4-3536	5,5	4	221													190	181	173	164	154	143	112	72
FB4-3549	7,5	5,5	302													257	246	234	222	209	193	151	96

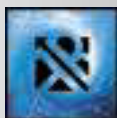
TABELLA DELLE CARATTERISTICHE IDRAULICHE 4"

4" HYDRAULIC FEATURES' CHART

TABLE DES CARACTÉRISTIQUES HYDRAULIQUES 4"

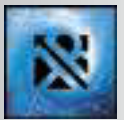

n=2900 1/min 50 Hz

Tipo Type Type	Motore Motor Moteur		Q = Portata - Capacity - Débit																			
			l/sec	0	1,33	1,5	1,67	2	2,33	2,67	3	3,33	3,67	4	4,33	4,67	5	5,33	5,67	6	6,33	6,67
			l/min	0	80	90	100	120	140	160	180	200	220	240	260	280	300	320	340	360	380	400
			Hp	Kw	mc/h	0	4,8	5,4	6	7,2	8,4	9,6	10,8	12	13	14,4	16	17	18	19	20	22
FB4-4004	1	0,75	H(m)	26	24	23	22	21	19	17	15	12										
FB4-4006	1,5	1,1		39	36	35	34	32	29	26	22	17										
FB4-4008	2	1,5		52	48	47	46	43	39	35	29	24										
FB4-4013	3	2,2		82	75	73	71	66	59	50	40	30										
FB4-4017	4	3		108	98	96	94	87	79	70	58	46										
FB4-4023	5,5	4		148	134	131	127	118	108	95	79	60										
FB4-4032	7,5	5,5		202	182	178	172	160	143	125	105	80										
FB4X-4050	10	7,5		286	250	242	235	223	205	175	140	102										
FB4-6007	2	1,5	H(m)	45			37	36	33	31	28	25	22	18	14							
FB4-6010	3	2,2		64			54	52	48	44	41	36	32	26	20							
FB4-6014	4	3		89			76	72	67	62	56	49	43	35	28							
FB4-6019	5,5	4		120			102	97	91	89	76	68	58	48	37							
FB4-6026	7,5	5,5		163			136	129	120	111	100	87	75	61	48							
FB4-8008	3	2,2	H(m)	51					41	39	37	35	33	31	29	27	24	22	20	17	14	12
FB4-8011	4	3		70					57	54	52	49	47	44	41	38	34	31	28	24	21	18
FB4-8015	5,5	4		97					79	76	73	69	66	63	58	54	50	46	41	36	32	27
FB4-8020	7,5	5,5		125					102	98	94	89	84	79	74	70	65	60	54	48	43	37
FB4-8026	10	7,5		158					126	121	116	112	106	100	95	92	88	80	73	65	56	46

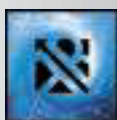

Tipo Type Type	Monofase Single-phase Monophasé	Trifase Three-phase Triphasé	Motore Motors 2900 g/m Moteurs		Q = Portata - Capacity - Débit											
					Cv Hp	Kw	l/sec	0	0,08	0,17	0,25	0,33	0,42			
							l/min	0	5	10	15	20	25			
							mc/h	0	0,3	0,6	0,9	1,2	1,5			
FB4-0513	4B0.5M	4B0.5	0,5	0,37	H(m)	86	78	70	56	42	23					
FB4-0519	4B0.75M	4B0.75	0,75	0,55		126	118	105	86	60	30					
FB4-0526	4B1M	4B1	1	0,75		173	160	141	117	81	39					
FB4-0538	4B1.5M	4B1.5	1,5	1,1		253	234	208	169	117	52					
■ FB4X-0550	4B2M	4B2	2	1,5		283	271	246	199	140	73					

Dimensioni e pesi

Overall dimensions and weights - Dimensions d'encombrement et poids

Tipo Type Type	Cv Hp	Kw	Tensione Voltage Voltage	A mm	B mm	C mm	D mm	ø max	DN	Peso - Weight - Poids		
										A (kg)	B (kg)	C (kg)
FB4-0513 + 4B0.5M	0,5	0,37	Monofase Single-phase Monophasé	734	377	357	94 mm	98 mm	1"1/4	10,6	3,7	6,9
FB4-0519 + 4B0.75M	0,75	0,55		858	481	377				12,8	4,7	8,1
FB4-0526 + 4B1M	1	0,75		1034	642	392				14,4	5,8	8,6
FB4-0538 + 4B1.5M	1,5	1,1		1281	864	417				18,0	8,2	9,8
■ FB4X-0550 + 4B2M	2	1,5		1666	1240	426				26,2	14,2	12
FB4-0513 + 4B0.5	0,5	0,37	Trifase Three-phase Triphasé	718	377	341	94 mm	98 mm	1"1/4	10,1	3,7	6,4
FB4-0519 + 4B0.75	0,75	0,55		838	481	357				11,9	4,7	7,2
FB4-0526 + 4B1	1	0,75		1019	642	377				13,8	5,8	8
FB4-0538 + 4B1.5	1,5	1,1		1256	864	392				17,1	8,2	8,9
■ FB4X-0550 + 4B2	2	1,5		1626	1240	386				24,3	14,2	10,1



- Corpo pompa e giranti in acciaio inox AISI 304
- AISI 304 stainless steel pumps and impellers
- Pompe et roues en acier inoxydable AISI 304

CURVE DELLE PRESTAZIONI

PERFORMANCES' CURVES

COURBES DES PERFORMANCES

FB4-05



n=2900 1/min 50 Hz

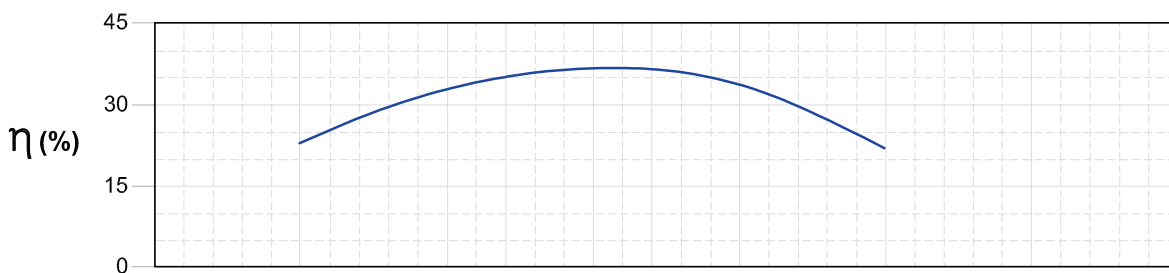
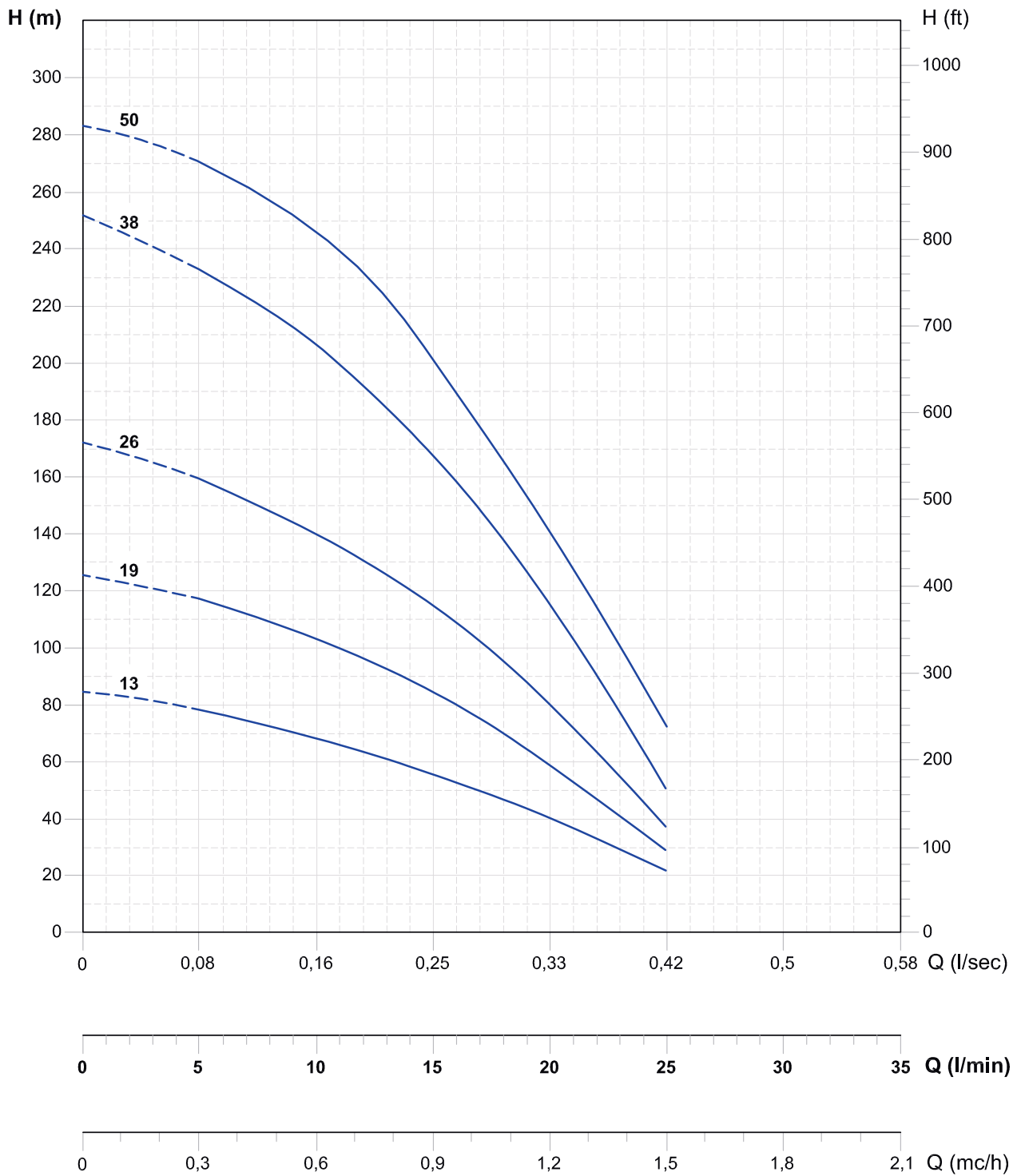

Tolleranze secondo EN ISO 9906 app.A Gr.2 - Tolerances according to EN ISO 9906 anx.A Gr.2 - Tolérances conformes EN ISO 9906 ann.A Gr.2
Rispetta il Reg. UE n° 547/2012 con MEI = 0.40 - Comply with Reg. UE n° 547/2012 with MEI = 0.40 - Conforme Reg. UE n°547/2012 avec MEI =0.40

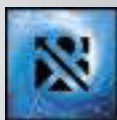

Tipo Type Type	Monofase Single-phase Monophasé	Trifase Three-phase Triphasé	Motore Motors 2900 g/m Moteurs		Q = Portata - Capacity - Débit									
			Cv Hp	Kw	l/sec	0	0,25	0,33	0,42	0,50	0,58	0,67	0,75	0,83
					l/min	0	15	20	25	30	35	40	45	50
					mc/h	0	0,9	1,2	1,5	1,8	2,1	2,4	2,7	3
FB4-1007	4B0.5M	4B0.5	0,5	0,37	H(m)	46	43	42	39	36	33	29	26	22
FB4-1010	4B0.75M	4B0.75	0,75	0,55		69	65	63	60	55	50	44	37	29
FB4-1014	4B1M	4B1	1	0,75		92	86	83	79	74	67	60	52	42
FB4-1020	4B1.5M	4B1.5	1,5	1,1		139	131	127	120	111	101	90	75	60
FB4-1028	4B2M	4B2	2	1,5		189	178	172	164	153	140	126	108	90
FB4-1040	4B3M	4B3	3	2,2		265	247	237	224	208	189	170	147	120
■ FB4X-1065*	---	4B4	4	3		376	336	320	285	245	201	153	82	29

Dimensioni e pesi

Overall dimensions and weights - Dimensions d'encombrement et poids

Tipo Type Type	Cv Hp	Kw	Tensione Voltage Voltage	A (mm)	B (mm)	C (mm)	D mm	ø max	DN	Peso - Weight - Poids		
										A (kg)	B (kg)	C (kg)
FB4-1007 + 4B0.5M	0,5	0,37	Monofase Single-phase Monophasé	628	271	357	94 mm	98 mm	1"1/4	9,7	2,8	6,9
FB4-1010 + 4B0.75M	0,75	0,55		701	324	377				11,4	3,3	8,1
FB4-1014 + 4B1M	1	0,75		786	394	392				12,5	3,9	8,6
FB4-1020 + 4B1.5M	1,5	1,1		916	499	417				14,7	4,9	9,8
FB4-1028 + 4B2M	2	1,5		1132	680	452				18,3	6,9	11,4
FB4-1040 + 4B3M	3	2,2		1392	885	507				23,1	9,3	13,8
FB4-1007 + 4B0.5	0,5	0,37	Trifase Three-phase Triphasé	613	271	342	94 mm	98 mm	1"1/4	9,2	2,8	6,4
FB4-1010 + 4B0.75	0,75	0,55		681	324	357				10,5	3,3	7,2
FB4-1014 + 4B1	1	0,75		771	394	377				11,9	3,9	8
FB4-1020 + 4B1.5	1,5	1,1		891	499	392				13,8	4,9	8,9
FB4-1028 + 4B2	2	1,5		1097	680	417				17,1	6,9	10,2
FB4-1040 + 4B3	3	2,2		1337	885	452				21	9,3	11,7
■ FB4X-1065 + 4B4*	4	3	2005	1555	450	30,9	18,9	12				

- Corpo pompa e giranti in acciaio inox AISI 304
- AISI 304 stainless steel pumps and impellers
- Pompe et roues en acier inoxydable AISI 304

* Non consigliata per montaggio in posizione orizzontale

* This electropump isn't recommended for horizontal assembly

* Cette électropompe n'est pas recommandée pour le montage en position horizontale



CURVE DELLE PRESTAZIONI

PERFORMANCES' CURVES

COURBES DES PERFORMANCES

FB4-10

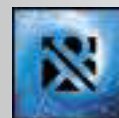

n=2900 1/min 50 Hz

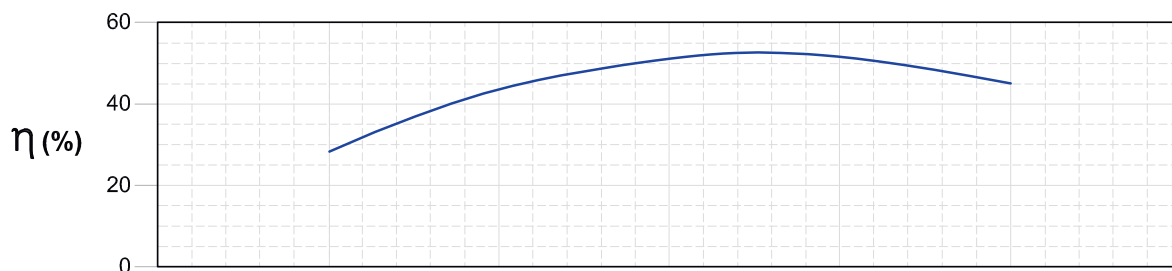
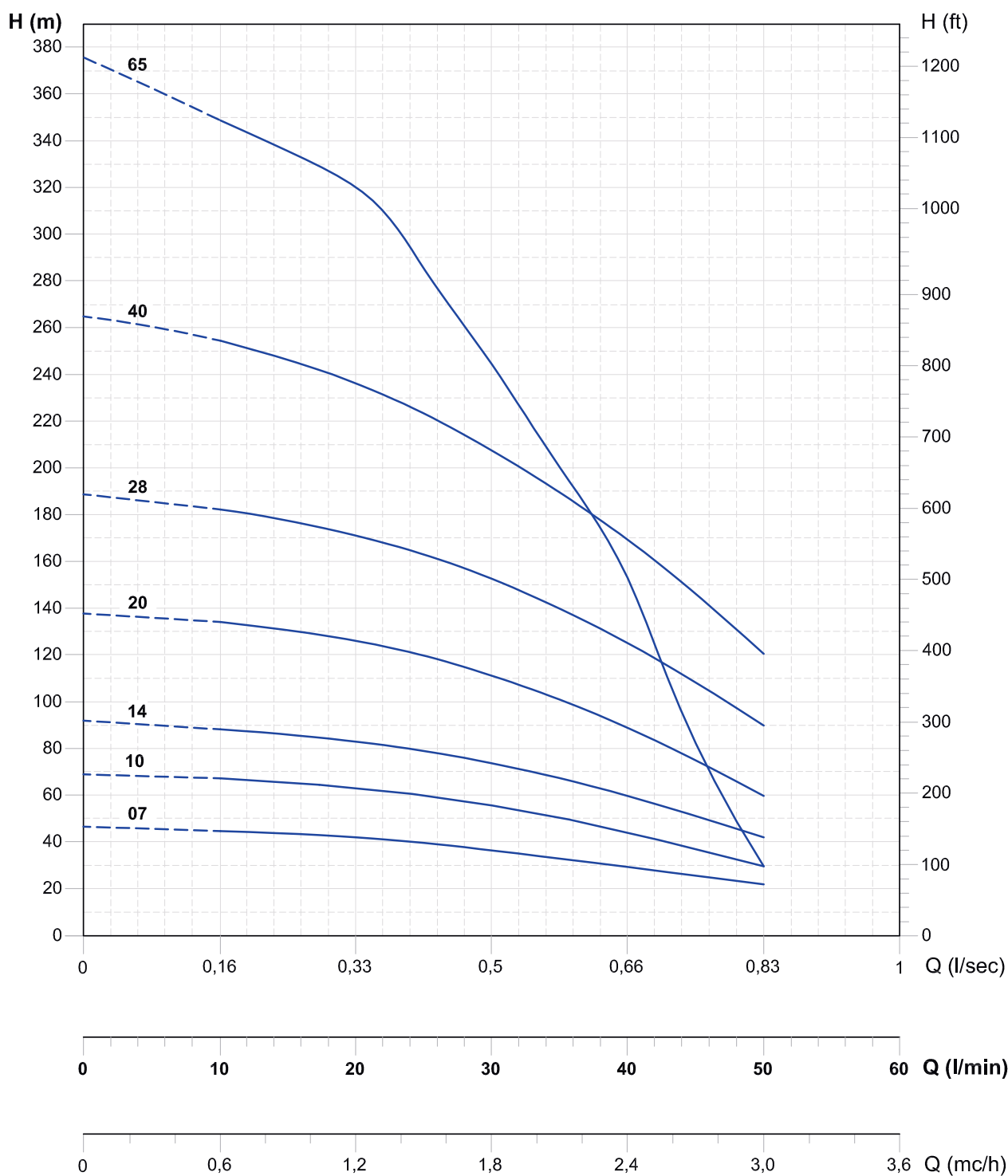

Tolleranze secondo EN ISO 9906 app.A Gr.2 - Tolerances according to EN ISO 9906 anx.A Gr.2 - Tolérances conformes EN ISO 9906 ann.A Gr.2
Rispetta il Reg. UE n° 547/2012 con MEI = 0.40 - Comply with Reg. UE n° 547/2012 with MEI = 0.40 - Conforme Reg. UE n°547/2012 avec MEI =0.40

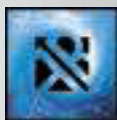

Tipo Type Type	Monofase Single-phase Monophasé	Trifase Three-phase Triphasé	Motore Motors 2900 g/m Moteurs		Q = Portata - Capacity - Débit									
			Cv Hp	Kw	l/sec	0	0,33	0,42	0,50	0,58	0,67	0,83	1	1,17
					l/min	0	20	25	30	35	40	50	60	70
					mc/h	0	1,2	1,5	1,8	2,1	2,4	3	3,6	4,2
FB4-1305	4B0.5M	4B0.5	0,5	0,37	H(m)	34	32	31	30	29	28	24	19	13
FB4-1308	4B0.75M	4B0.75	0,75	0,55		54	51	50	49	46	43	38	30	19
FB4-1311	4B1M	4B1	1	0,75		72	68	66	64	61	58	49	38	26
FB4-1316	4B1.5M	4B1.5	1,5	1,1		106	101	98	95	89	83	70	54	33
FB4-1321	4B2M	4B2	2	1,5		142	135	132	127	122	115	100	79	49
FB4-1332	4B3M	4B3	3	2,2		208	200	194	187	177	165	138	104	62
■ FB4X-1345	---	4B4	4	3		288	269	250	243	233	224	199	162	110
■ FB4X-1360*	---	4B5.5	5,5	4		392	350	336	325	312	297	260	210	143

Dimensioni e pesi

Overall dimensions and weights - Dimensions d'encombrement et poids

Tipo Type Type	Cv Hp	Kw	Tensione Voltage Voltage	A mm	B mm	C mm	D mm	ø max	DN	Peso - Weight - Poids		
										A (kg)	B (kg)	C (kg)
FB4-1305 + 4B0.5M	0,5	0,37	Monofase Single-phase Monophasé	593	236	357	94 mm	98 mm	1"1/4	9,4	2,5	6,9
FB4-1308 + 4B0.75M	0,75	0,55		666	289	377				11	2,9	8,1
FB4-1311 + 4B1M	1	0,75		734	342	392				12	3,4	8,6
FB4-1316 + 4B1.5M	1,5	1,1		847	430	417				14	4,2	9,8
FB4-1321 + 4B2M	2	1,5		971	519	452				16,4	5	11
FB4-1332 + 4B3M	3	2,2		1256	749	507				20,9	7,1	13,8
FB4-1305 + 4B0.5	0,5	0,37	Trifase Three-phase Triphasé	578	236	342	94 mm	98 mm	1"1/4	8,9	2,5	6,4
FB4-1308 + 4B0.75	0,75	0,55		646	289	357				10,1	2,9	7,2
FB4-1311 + 4B1	1	0,75		719	342	377				11,4	3,4	8
FB4-1316 + 4B1.5	1,5	1,1		822	430	392				13,1	4,2	8,9
FB4-1321 + 4B2	2	1,5		936	519	417				15,2	5	10,2
FB4-1332 + 4B3	3	2,2		1201	749	452				18,8	7,1	11,7
■ FB4X-1345 + 4B4	4	3		1640	1135	505				26,6	13,7	12,9
■ FB4X-1360 + 4B5.5*	5,5	4		2060	1450	610				38,2	17,7	20,5

- Corpo pompa e giranti in acciaio inox AISI 304
- AISI 304 stainless steel pumps and impellers
- Pompe et roues en acier inoxydable AISI 304

* Non consigliata per montaggio in posizione orizzontale

* This electropump isn't recommended for horizontal assemblage

* Cette electropompe n'est pas recommandée pour le montage en position horizontale



CURVE DELLE PRESTAZIONI

PERFORMANCES' CURVES

COURBES DES PERFORMANCES

FB4-13

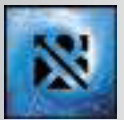

n=2900 1/min 50 Hz

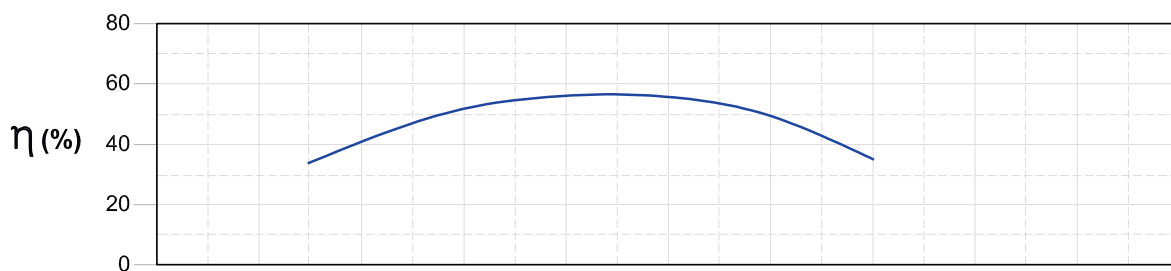
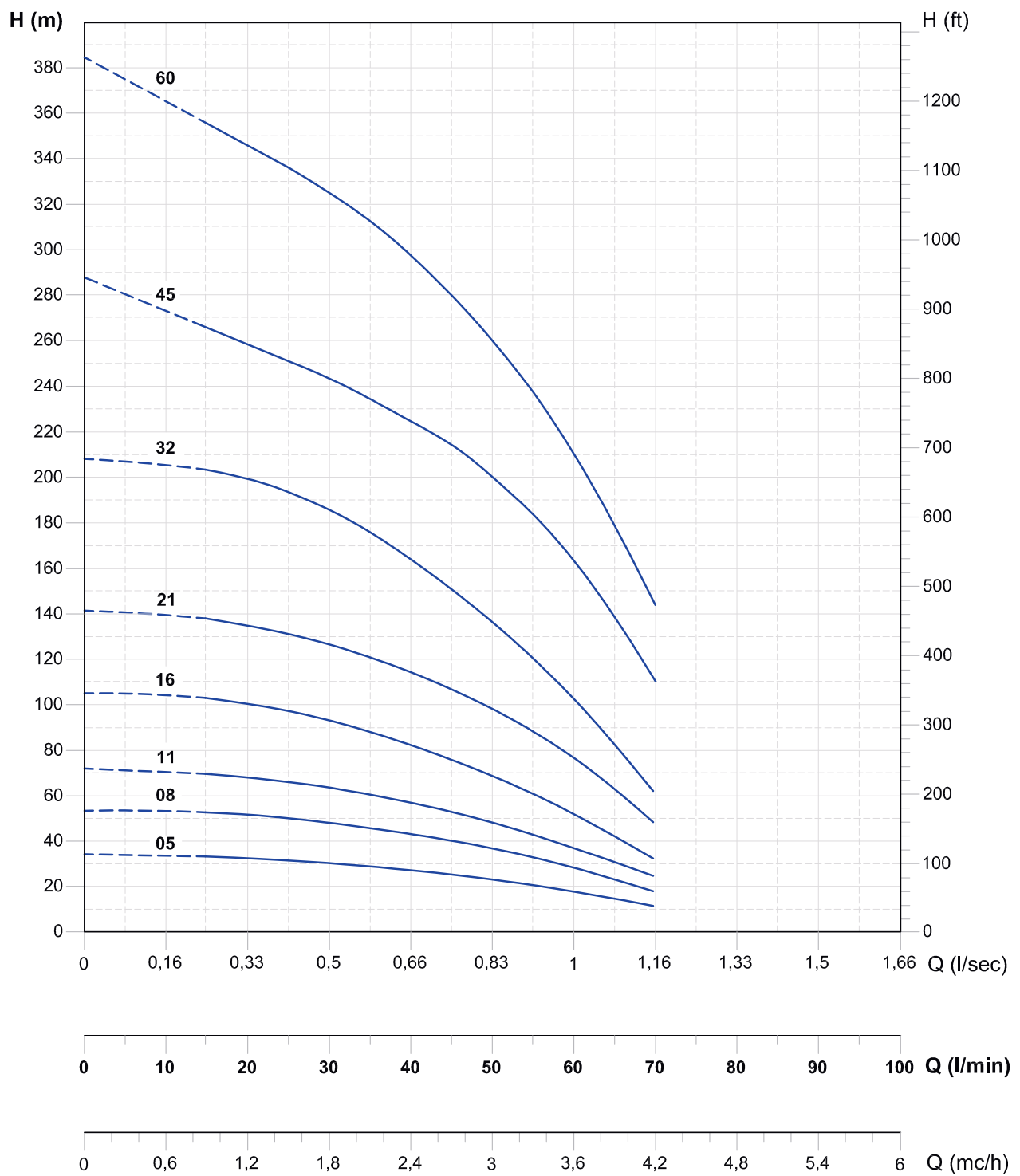

Tolleranze secondo EN ISO 9906 app.A Gr.2 - Tolerances according to EN ISO 9906 anx.A Gr.2 - Tolérances conformes EN ISO 9906 ann.A Gr.2
 Rispetta il Reg. UE n° 547/2012 con MEI = 0.40 - Comply with Reg. UE n° 547/2012 with MEI = 0.40 - Conforme Reg. UE n°547/2012 avec MEI =0.40

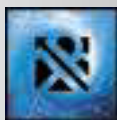

FB4-18

DATI DELLE PRESTAZIONI
PERFORMANCES' DATA
DONNÉES DES PERFORMANCES

Tipo Type Type	Monofase Single-phase Monophasé	Trifase Three-phase Triphasé	Motore Motors 2900 g/m Moteurs		Q = Portata - Capacity - Débit									
			Cv Hp	Kw	l/sec	0	0,33	0,50	0,67	0,83	1	1,17	1,33	1,67
					l/min	0	20	30	40	50	60	70	80	100
					mc/h	0	1,2	1,8	2,4	3	3,6	4,2	4,8	6
FB4-1805	4B0.5M	4B0.5	0,5	0,37	H(m)	33	29	28	26	24	21	18	13	3
FB4-1807	4B0.75M	4B0.75	0,75	0,55		46	43	42	40	37	33	28	21	7
FB4-1809	4B1M	4B1	1	0,75		59	55	54	51	47	43	37	28	10
FB4-1814	4B1.5M	4B1.5	1,5	1,1		93	87	86	81	76	68	58	47	20
FB4-1818	4B2M	4B2	2	1,5		120	113	111	105	98	88	75	60	25
FB4-1827	4B3M	4B3	3	2,2		175	164	161	152	141	127	109	87	35
FB4-1835	---	4B4	4	3		231	217	212	202	189	170	149	120	50
FB4-1848*	---	4B5.5	5,5	4		322	299	292	276	256	231	199	160	70
■ FB4X-1860*	---	4B7.5	7,5	5,5		380	353	338	323	309	288	273	250	195

Dimensioni e pesi

Overall dimensions and weights - Dimensions d'encombrement et poids

Tipo Type Type	Cv Hp	Kw	Tensione Voltage Voltage	A mm	B mm	C mm	D mm	ø max	DN	Peso - Weight - Poids		
										A (kg)	B (kg)	C (kg)
FB4-1805 + 4B0.5M	0,5	0,37	Monofase Single-phase Monophasé	614	257	357	94 mm	98 mm	1"1/4	9,6	2,7	6,9
FB4-1807 + 4B0.75M	0,75	0,55		678	301	377				11,1	3	8,1
FB4-1809 + 4B1M	1	0,75		736	344	392				11,9	3,3	8,6
FB4-1814 + 4B1.5M	1,5	1,1		869	452	417				13,9	4,1	9,8
FB4-1818 + 4B2M	2	1,5		990	538	452				16,1	4,7	11
FB4-1827 + 4B3M	3	2,2		1274	767	507				20	6,2	13,8
FB4-1805 + 4B0.5	0,5	0,37	Trifase Three-phase Triphasé	599	257	342	94 mm	98 mm	1"1/4	9,1	2,7	6,4
FB4-1807 + 4B0.75	0,75	0,55		658	301	357				10,2	3	7,2
FB4-1809 + 4B1	1	0,75		721	344	377				11,3	3,3	8
FB4-1814 + 4B1.5	1,5	1,1		844	452	392				13	4,1	8,9
FB4-1818 + 4B2	2	1,5		955	538	417				14,9	4,7	10,2
FB4-1827 + 4B3	3	2,2		1219	767	452				17,9	6,2	11,7
FB4-1835 + 4B4	4	3		1441	934	507				23,3	7,9	15,4
FB4-1848 + 4B5.5*	5,5	4		1883	1253	630				29,6	10	19,6
■ FB4X-1860 + 4B7.5*	7,5	5,5		2135	1435	700				42,3	17,6	24,7



- Corpo pompa e giranti in acciaio inox AISI 304
- AISI 304 stainless steel pumps and impellers
- Pompe et roues en acier inoxydable AISI 304

* Non consigliata per montaggio in posizione orizzontale

* This electropump isn't recommended for horizontal assembly

* Cette electropompe n'est pas recommandée pour le montage en position horizontale

CURVE DELLE PRESTAZIONI

PERFORMANCES' CURVES

COURBES DES PERFORMANCES

FB4-18

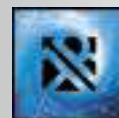

n=2900 1/min 50 Hz

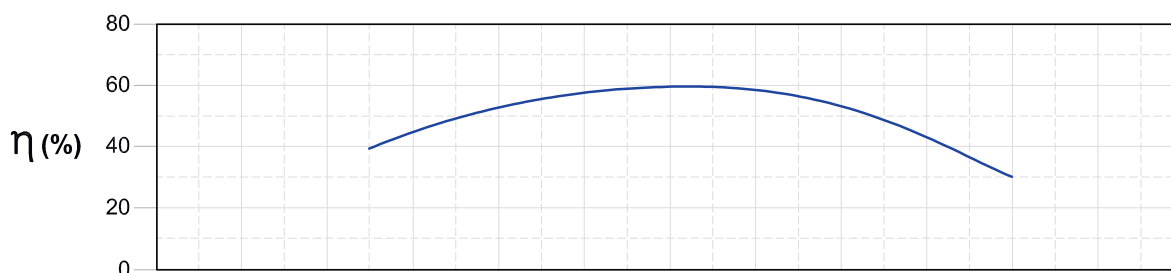
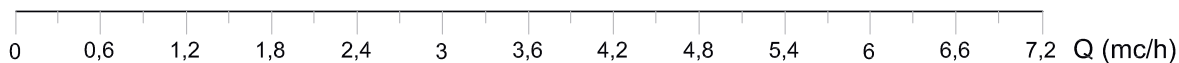
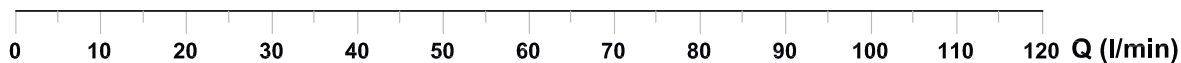
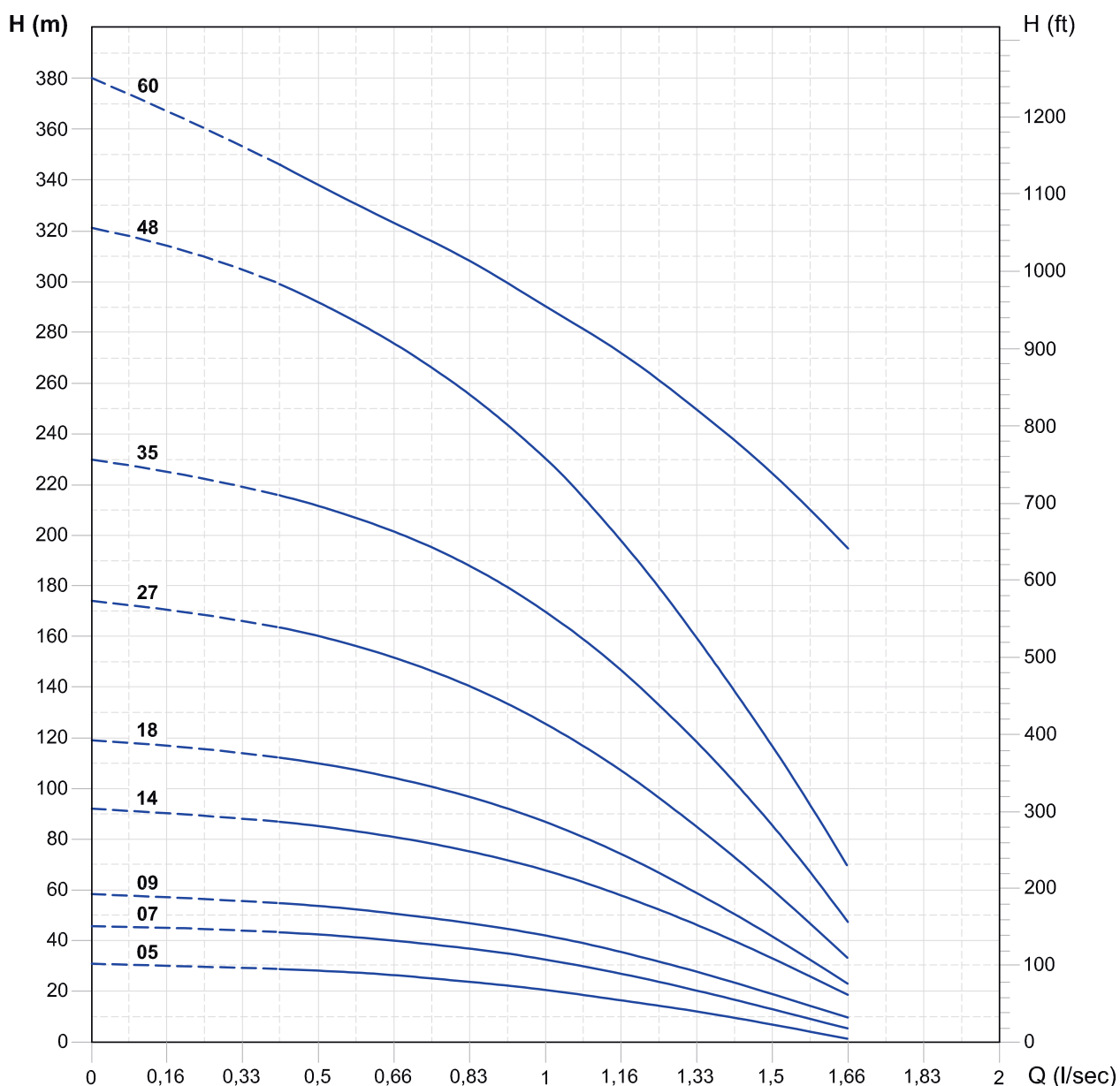

Tolleranze secondo EN ISO 9906 app.A Gr.2 - Tolerances according to EN ISO 9906 anx.A Gr.2 - Tolérances conformes EN ISO 9906 ann.A Gr.2
 Rispetta il Reg. UE n° 547/2012 con MEI = 0.40 - Comply with Reg. UE n° 547/2012 with MEI = 0.40 - Conforme Reg. UE n°547/2012 avec MEI =0.40

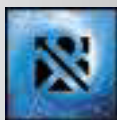

Tipo Type Type	Monofase Single-phase Monophasé	Trifase Three-phase Triphasé	Motore Motors 2900 g/m Moteurs		Q = Portata - Capacity - Débit									
			Cv Hp	Kw	l/sec	0	0,8	1	1,2	1,3	1,5	1,7	2	2,3
					l/min	0	50	60	70	80	90	100	120	140
			mc/h	0	2,7	3,6	4,2	4,8	5,4	6	7,2	8,4		
FB4-3507	4B1M	4B1	1	0,75	H(m)	42	36	34	32	30	28	25	19	11
FB4-3510	4B1.5M	4B1.5	1,5	1,1		62	53	51	48	45	41	38	29	18
FB4-3514	4B2M	4B2	2	1,5		90	77	74	71	68	63	59	46	28
FB4-3520	4B3M	4B3	3	2,2		125	107	102	97	92	86	80	62	40
FB4-3527	---	4B4	4	3		169	145	139	131	123	115	107	84	55
FB4-3536	---	4B5.5	5,5	4		221	190	181	173	164	154	143	112	72
FB4-3549*	---	4B7.5	7,5	5,5		302	257	246	234	222	209	193	151	96

Dimensioni e pesi

Overall dimensions and weights - Dimensions d'encombrement et poids

Tipo Type Type	Cv Hp	Kw	Tensione Voltage Voltage	A mm	B mm	C mm	D mm	ø max	DN	Peso - Weight - Poids		
										A (kg)	B (kg)	C (kg)
FB4-3507 + 4B1M	1	0,75	Monofase Single-phase Monophasé	782	390	392	94 mm	98 mm	2"	12,3	3,7	8,6
FB4-3510 + 4B1.5M	1,5	1,1		899	483	416				14,4	4,6	9,8
FB4-3514 + 4B2M	2	1,5		1059	607	452				17,1	5,7	11,4
FB4-3520 + 4B3M	3	2,2		1338	831	507				21,3	7,5	13,8
FB4-3507 + 4B1	1	0,75	Trifase Three-phase Triphasé	782	390	392	94 mm	98 mm	2"	11,7	3,7	8
FB4-3510 + 4B1.5	1,5	1,1		899	483	416				13,5	4,6	8,9
FB4-3514 + 4B2	2	1,5		1059	607	452				15,9	5,7	10,2
FB4-3520 + 4B3	3	2,2		1283	831	452				19,2	7,5	11,7
FB4-3527 + 4B4	4	3		1555	1048	507				25	9,6	15,4
FB4-3536 + 4B5.5	5,5	4		1948	1318	630				31,8	12,2	19,6
FB4-3549 + 4B7.5*	7,5	5,5		2492	1802	690				39,3	15,9	23,4

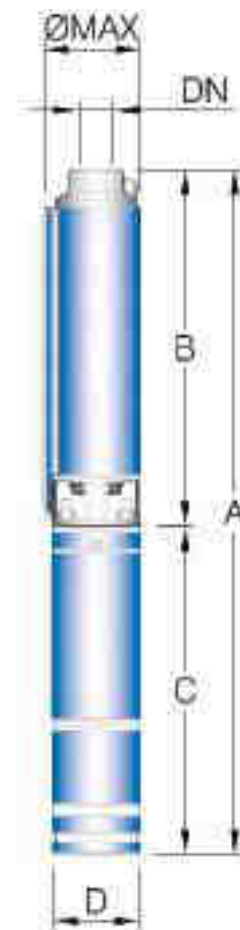

* Non consigliata per montaggio in posizione orizzontale

* This electropump isn't recommended for horizontal assemblage

* Cette électropompe n'est pas recommandée pour le montage en position horizontale

CURVE DELLE PRESTAZIONI

PERFORMANCES' CURVES

COURBES DES PERFORMANCES

FB4-35

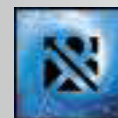

n=2900 1/min 50 Hz

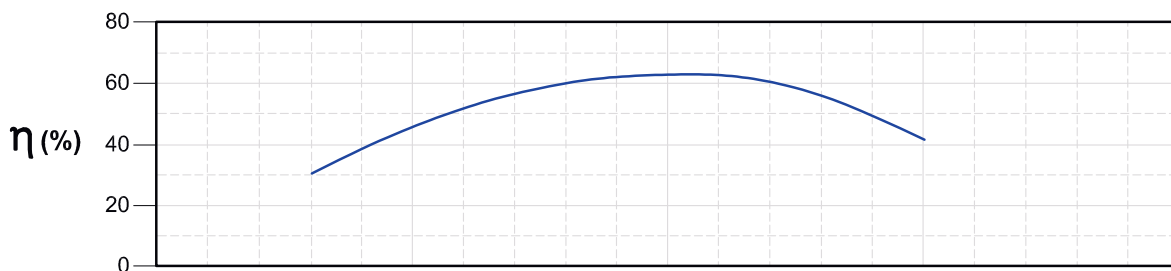
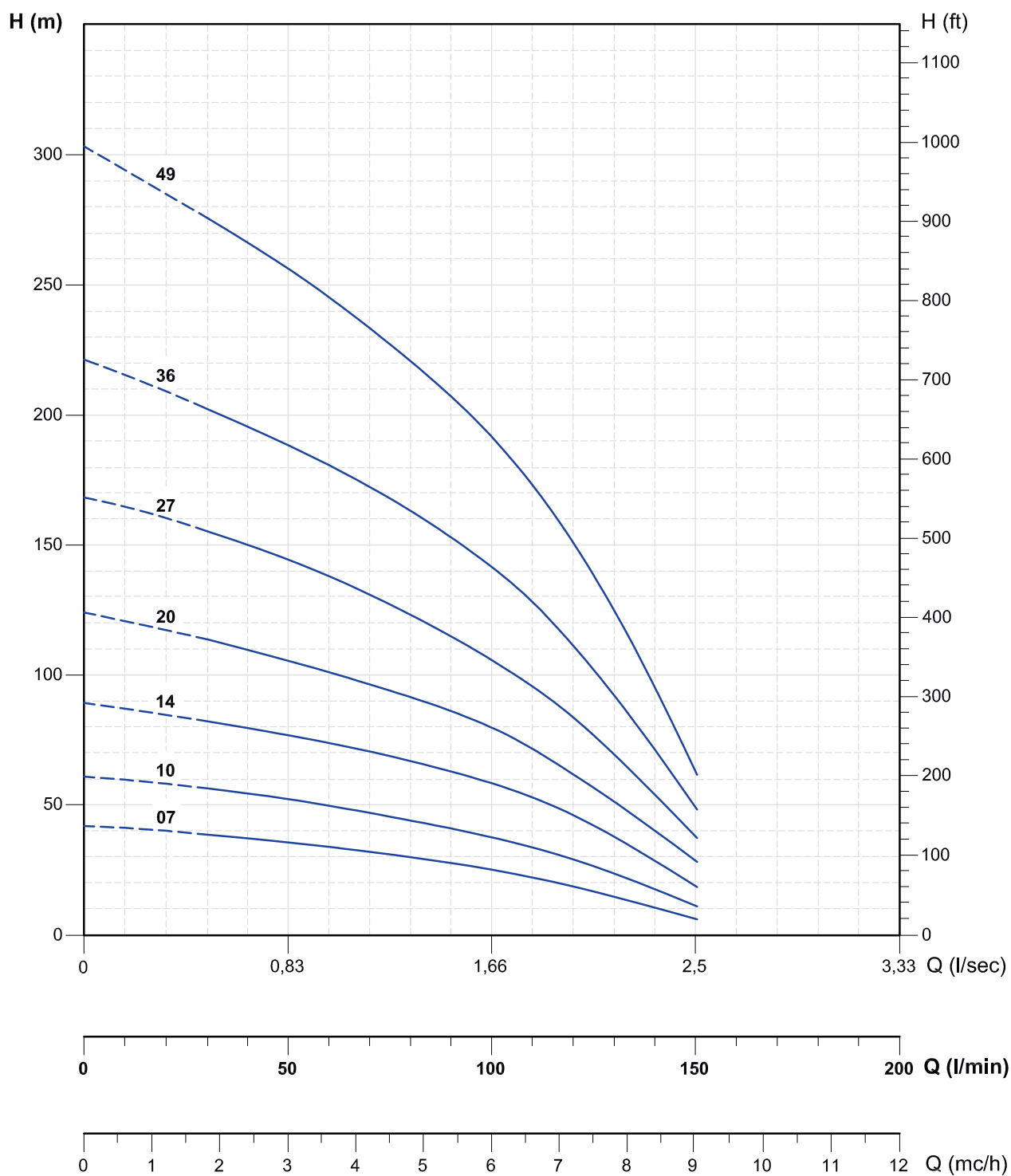

Tolleranze secondo EN ISO 9906 app.A Gr.2 - Tolerances according to EN ISO 9906 anx.A Gr.2 - Tolérances conformes EN ISO 9906 ann.A Gr.2
Rispetta il Reg. UE n° 547/2012 con MEI = 0.40 - Comply with Reg. UE n° 547/2012 with MEI = 0.40 - Conforme Reg. UE n°547/2012 avec MEI =0.40

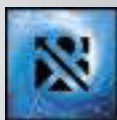

FB4-40

DATI DELLE PRESTAZIONI PERFORMANCES' DATA DONNÉES DES PERFORMANCES

Tipo Type Type	Monofase Single-phase Monophasé	Trifase Three-phase Triphasé	Motore Motors 2900 g/m Moteurs		Q = Portata - Capacity - Débit									
					Cv Hp	Kw	l/sec	0	1,3	1,5	1,7	2	2,3	2,7
			l/min	0			80	90	100	120	140	160	180	200
			mc/h	0			4,8	5,4	6	7,2	8,4	9,6	10,8	12
FB4-4004	4B1M	4B1	1	0,75	H(m)	26	24	23	22	21	19	17	15	12
FB4-4006	4B1.5M	4B1.5	1,5	1,1		39	36	35	34	32	29	26	22	17
FB4-4008	4B2M	4B2	2	1,5		52	48	47	46	43	39	35	29	24
FB4-4013	4B3M	4B3	3	2,2		82	75	73	71	66	59	50	40	30
FB4-4017	---	4B4	4	3		108	98	96	94	87	79	70	58	46
FB4-4023	---	4B5.5	5,5	4		148	134	131	127	118	108	95	79	60
FB4-4032*	---	4B7.5	7,5	5,5		202	182	178	172	160	143	125	105	80
■ FB4X-4050*	---	4B10	10	7,5		286	250	242	235	223	205	175	140	102

Dimensioni e pesi

Overall dimensions and weights - Dimensions d'encombrement et poids

Tipo Type Type	Cv Hp	Kw	Tensione Voltage Voltage	A mm	B mm	C mm	D mm	ø max	DN	Peso - Weight - Poids		
										A (kg)	B (kg)	C (kg)
FB4-4004 + 4B1M	1	0,75	Monofase Single-phase Monophasé	686	294	392	94 mm	98 mm	2"	11,4	2,8	8,6
FB4-4006 + 4B1.5M	1,5	1,1		772	356	416				13,2	3,4	9,8
FB4-4008 + 4B2M	2	1,5		870	418	452				15,4	4	11,4
FB4-4013 + 4B3M	3	2,2		1080	573	507				19,3	5,5	13,8
FB4-4004 + 4B1	1	0,75	Trifase Three-phase Triphasé	671	294	377	94 mm	98 mm	2"	10,8	2,8	8
FB4-4006 + 4B1.5	1,5	1,1		748	356	392				12,3	3,4	8,9
FB4-4008 + 4B2	2	1,5		835	418	417				14,2	4	10,2
FB4-4013 + 4B3	3	2,2		1025	573	452				17,2	5,5	11,7
FB4-4017 + 4B4	4	3		1204	697	507				22	6,6	15,4
FB4-4023 + 4B5.5	5,5	4		1489	859	630				28	8,4	19,6
FB4-4032 + 4B7.5*	7,5	5,5		1928	1238	690				37,4	14	23,4
■ FB4X-4050 + 4B10*	10	7,5		3099	2299	800				68,2	39	29,2

■ Corpo pompa e giranti in acciaio inox AISI 304

■ AISI 304 stainless steel pumps and impellers

■ Pompe et roues en acier inoxydable AISI 304

* Non consigliata per
montaggio in posizione
orizzontale

* This electropump isn't
recommended for horizontal
assemblage

* Cette electropompe n'est pas
recommandée pour le montage
en position horizontale



CURVE DELLE PRESTAZIONI

PERFORMANCES' CURVES

COURBES DES PERFORMANCES

FB4-40

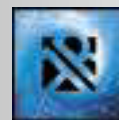

n=2900 1/min 50 Hz

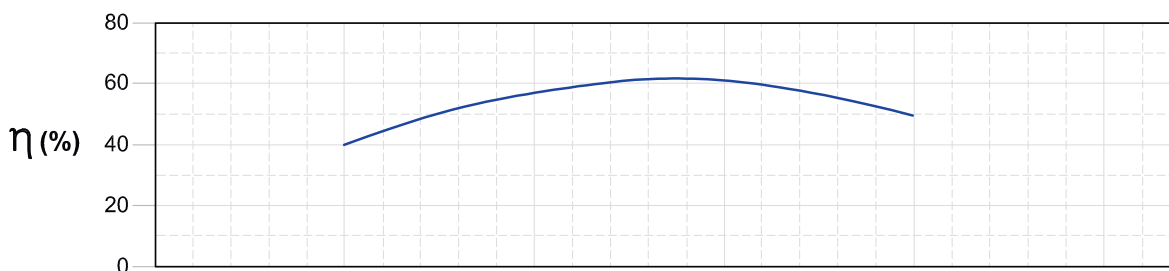
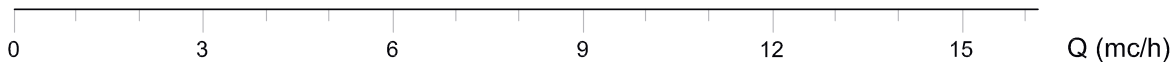
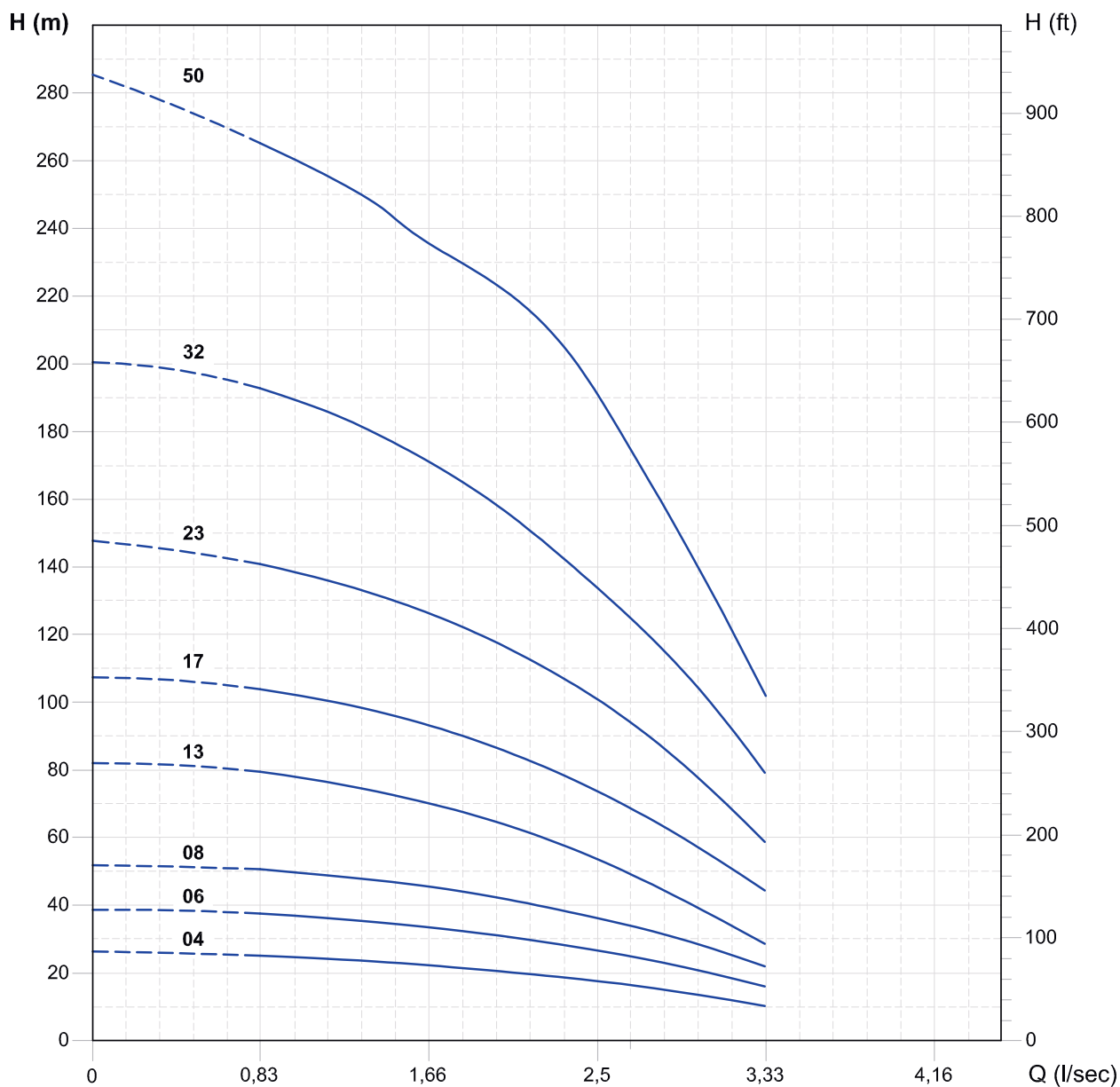

Tolleranze secondo EN ISO 9906 app.A Gr.2 - Tolerances according to EN ISO 9906 anx.A Gr.2 - Tolérances conformes EN ISO 9906 ann.A Gr.2
 Rispetta il Reg. UE n° 547/2012 con MEI = 0.40 - Comply with Reg. UE n° 547/2012 with MEI = 0.40 - Conforme Reg. UE n°547/2012 avec MEI=0.40

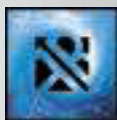

Tipo Type Type	Monofase Single-phase Monophasé	Trifase Three-phase Triphasé	Motore Motors 2900 g/m Moteurs		Q = Portata - Capacity - Débit											
					l/sec	0	1,7	2,3	2,7	3	3,3	3,7	4	4,3		
					Cv Hp	Kw	l/min	0	100	140	160	180	200	220	240	260
					mc/h	0	6	8,4	9,6	10,8	12	13	14,4	16		
FB4-6007	4B2M	4B2	2	1,5	H(m)	45	37	33	31	28	25	22	18	14		
FB4-6010	4B3M	4B3	3	2,2		64	54	48	44	41	36	32	26	20		
FB4-6014	---	4B4	4	3		89	76	67	62	56	49	43	35	28		
FB4-6019	---	4B5.5	5,5	4		120	102	91	89	76	68	58	48	37		
FB4-6026*	---	4B7.5	7,5	5,5		163	136	120	111	100	87	75	61	48		

Dimensioni e pesi

Overall dimensions and weights - Dimensions d'encombrement et poids

Tipo Type Type	Cv Hp	Kw	Tensione Voltage Voltage	A mm	B mm	C mm	D mm	ø max	DN	Peso - Weight - Poids		
										A (kg)	B (kg)	C (kg)
FB4-6007 + 4B2M	2	1,5	Monofase Single-phase Monophasé	986	534	452	94 mm	98 mm	2"	16,7	5,3	11,4
FB4-6010 + 4B3M	3	2,2		1197	690	507				20,5	6,7	13,8
FB4-6007 + 4B2	2	1,5	Trifase Three-phase Triphasé	951	534	417	94 mm	98 mm	2"	15,5	5,3	10,2
FB4-6010 + 4B3	3	2,2		1142	690	452				18,4	6,7	11,7
FB4-6014 + 4B4	4	3		1496	989	507				24	8,6	15,4
FB4-6019 + 4B5.5	5,5	4		1825	1195	630				30,6	11	19,6
FB4-6026 + 4B7.5*	7,5	5,5		2249	1559	690				37,7	14,3	23,4

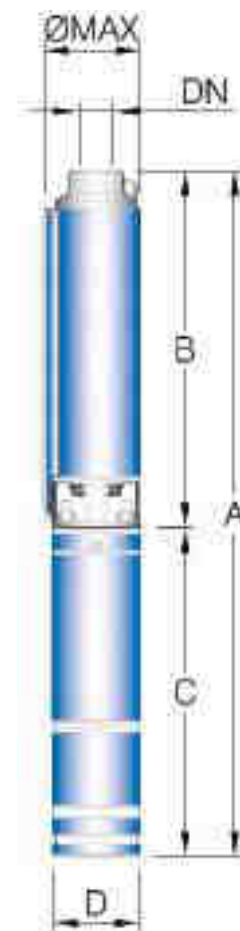

* Non consigliata per montaggio in posizione orizzontale

* This electropump isn't recommended for horizontal assemblage

* Cette électropompe n'est pas recommandée pour le montage en position horizontale

CURVE DELLE PRESTAZIONI

PERFORMANCES' CURVES

COURBES DES PERFORMANCES

FB4-60

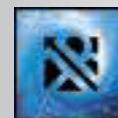

n=2900 1/min 50 Hz

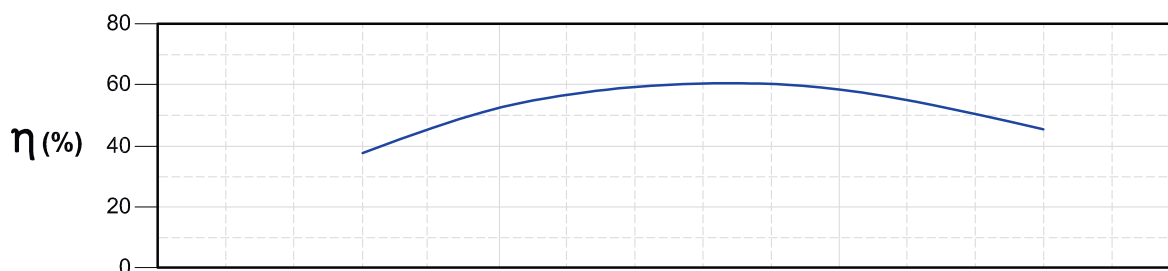
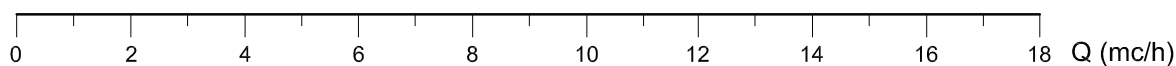
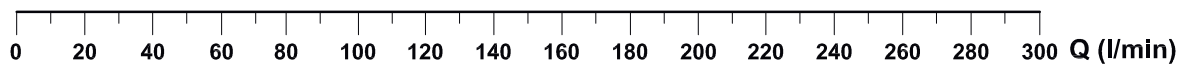
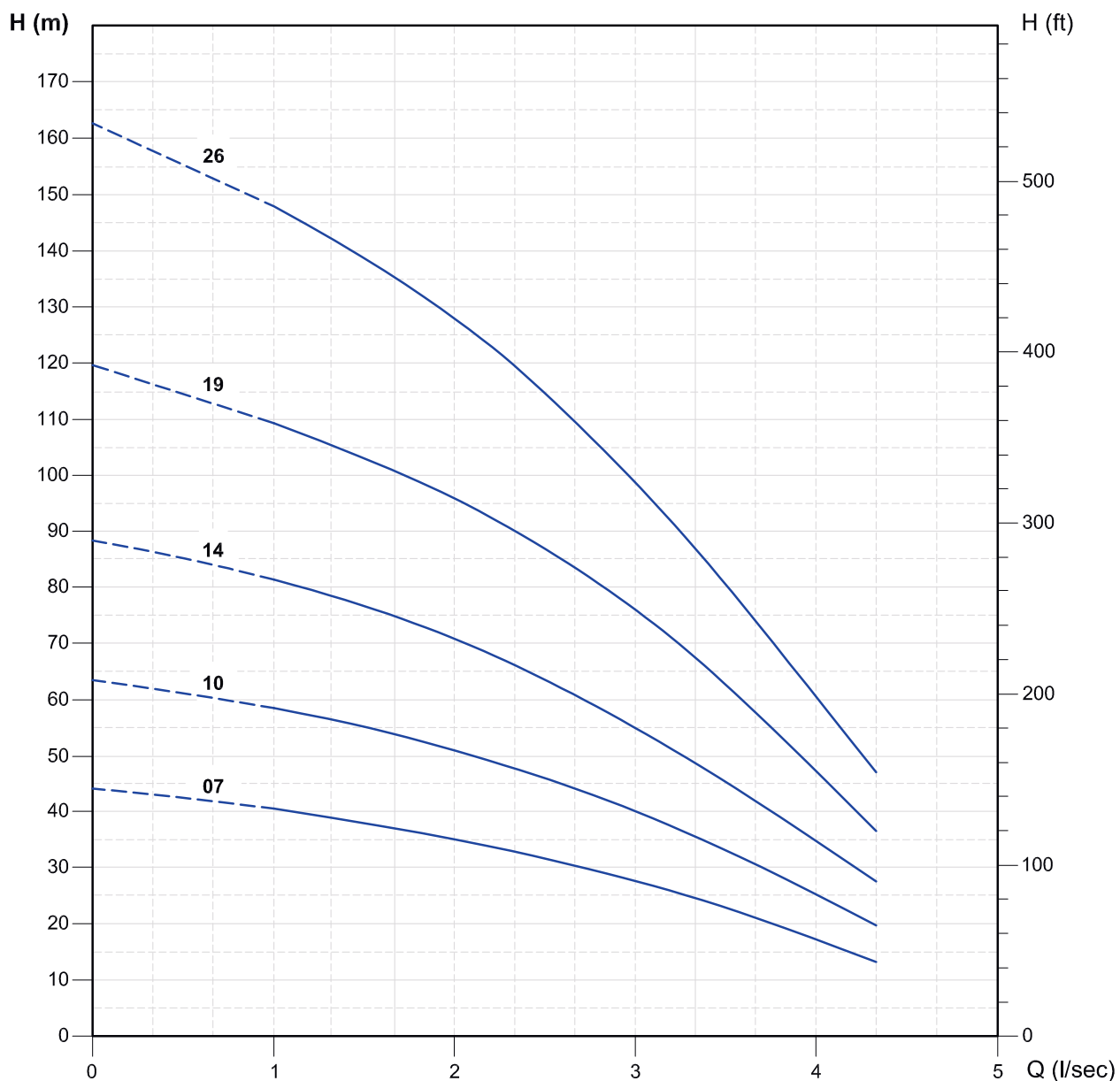

Tolleranze secondo EN ISO 9906 app.A Gr.2 - Tolerances according to EN ISO 9906 an. A Gr.2 - Tolérances conformes EN ISO 9906 ann.A Gr.2

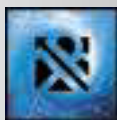

FB4-80

DATI DELLE PRESTAZIONI PERFORMANCES' DATA DONNÉES DES PERFORMANCES

Tipo Type Type	Monofase Single-phase Monophasé	Trifase Three-phase Triphasé	Motore Motors 2900 g/m Moteurs		Q = Portata - Capacity - Débit										
					l/sec	0	2,3	2,7	3,3	4	4,7	5,3	6	6,7	
					l/min	0	140	160	200	240	280	320	360	400	
					mc/h	0	8,4	9,6	12	14,4	17	19	22	24	
FB4-8008	4B3M	4B3	3	2,2	H(m)	51	41	39	35	31	27	22	17	12	
FB4-8011	---	4B4	4	3		70	57	54	49	44	38	31	24	18	
FB4-8015	---	4B5.5	5,5	4		97	79	76	69	63	54	46	36	27	
FB4-8020*	---	4B7.5	7,5	5,5		125	102	98	89	79	70	60	48	37	
FB4-8026*	---	4B10	10	7,5		158	126	121	112	100	92	80	65	46	

Dimensioni e pesi

Overall dimensions and weights - Dimensions d'encombrement et poids

Tipo Type Type	Cv Hp	Kw	Tensione Voltage Voltage	A mm	B mm	C mm	D mm	ø max	DN	Peso - Weight - Poids		
										A (kg)	B (kg)	C (kg)
FB4-8008 + 4B3M	3	2,2	Monofase Single-phase Monophasé	1183	676	507	94 mm	98 mm	2"	20,1	6,3	13,8
FB4-8008 + 4B3	3	2,2	Trifase Three-phase Triphasé	1128	676	452	94 mm	98 mm	2"	18	6,3	11,7
FB4-8011 + 4B4	4	3		1387	880	507				23,5	8,1	15,4
FB4-8015 + 4B5.5	5,5	4		1779	1149	630				30,1	10,5	19,6
FB4-8020 + 4B7.5*	7,5	5,5		2178	1489	689				36,9	13,5	23,4
FB4-8026 + 4B10*	10	7,5		2659	1869	790				44,7	16,9	27,8



* Non consigliata per montaggio in posizione orizzontale

* This electropump isn't recommended for horizontal assemblage

* Cette électropompe n'est pas recommandée pour le montage en position horizontale

CURVE DELLE PRESTAZIONI

PERFORMANCES' CURVES

COURBES DES PERFORMANCES

FB4-80

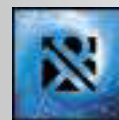

n=2900 1/min 50 Hz

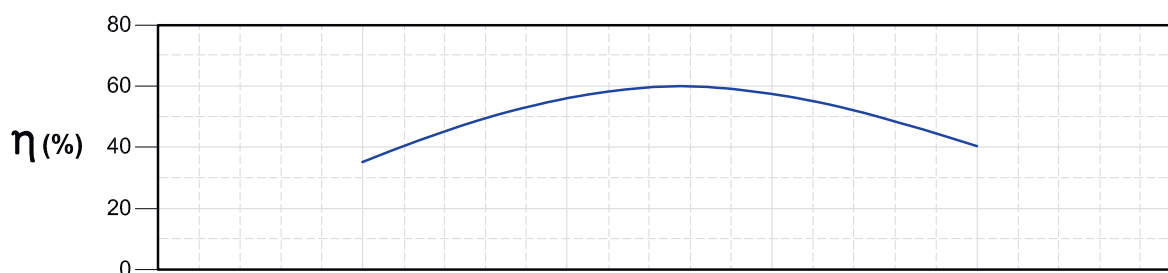
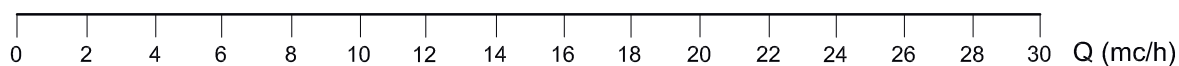
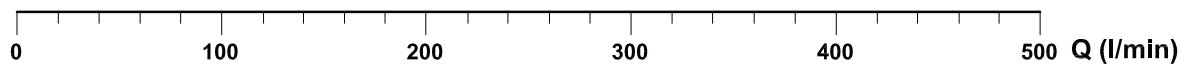
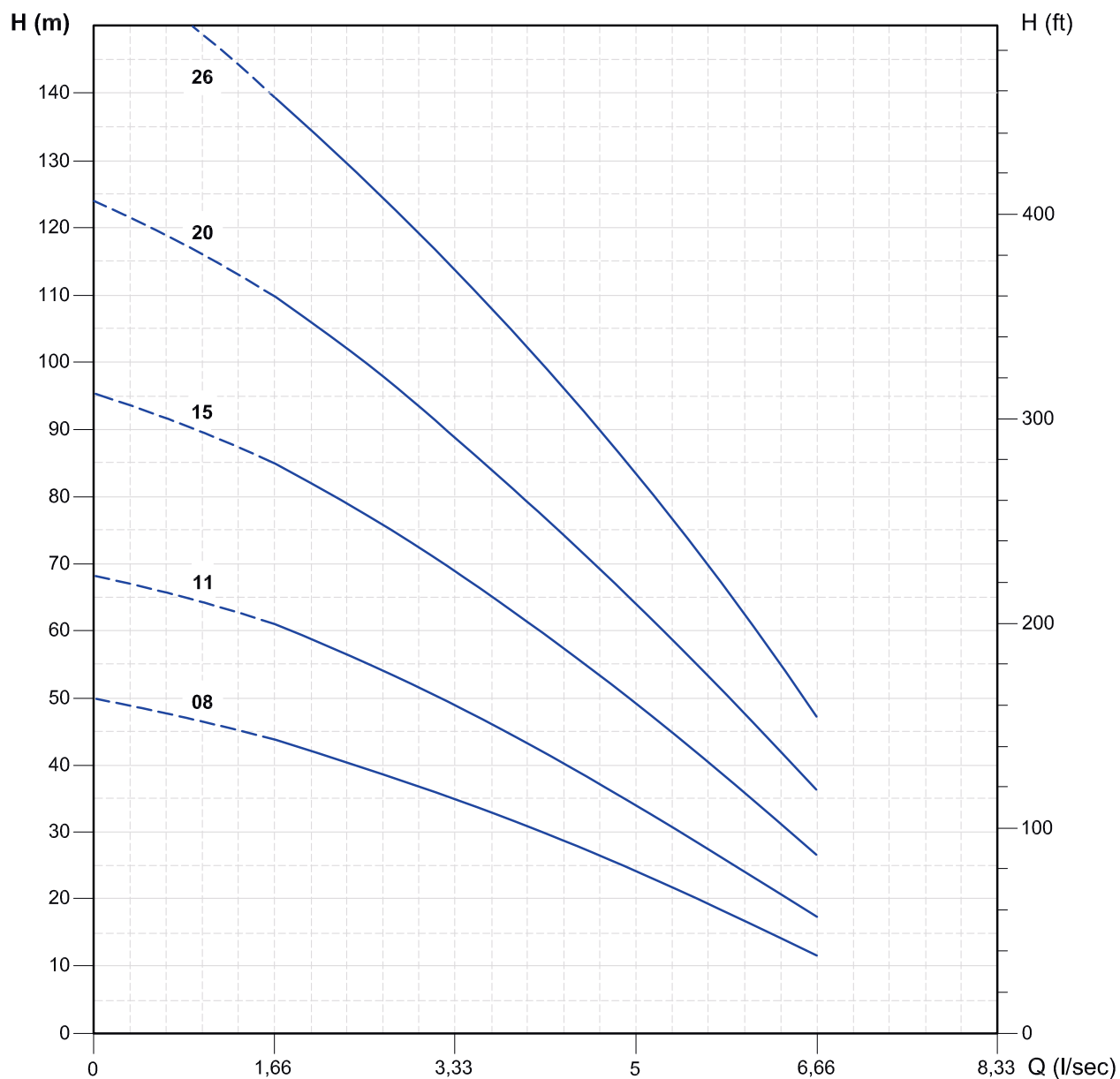

Tolleranze secondo EN ISO 9906 app.A Gr.2 - Tolerances according to EN ISO 9906 anx.A Gr.2 - Tolérances conformes EN ISO 9906 ann.A Gr.2

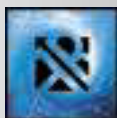

ELETTROPOMPE SOMMERSE 6"

6" SUBMERSIBLE ELECTROPUMPS

ÉLECTROPOMPES IMMERGÉES 6"



Le pompe sommerse 6", serie FB6R, sono per acque pulite per pozzi 6" DN 150.

La bocca di mandata e il supporto di aspirazione sono in acciaio inox microfuso in AISI 304.

Per garantire maggiore sicurezza alla pompa nelle grandi profondità (oltre i 40 bar), è stato realizzato un nuovo sistema per alleggerire la pressione sulle giranti: la singola pompa diventa un gruppo di due corpi pompa in serie, identificate con il modello FB6R.../...D.

APPLICAZIONI:

- irrigazione
- approvvigionamento idrico
- aumento pressione
- antincendio

CONSTRUZIONE:

- supporto di aspirazione e bocca di mandata in acciaio inox microfuso AISI 304
- valvola di non ritorno in acciaio inox AISI 304
- camicia esterna in acciaio inox AISI 304
- albero in acciaio inox AISI 420
- giranti in noryl
- diffusori in noryl
- tubo distanziale in acciaio inox AISI 304
- copri cavo in acciaio inox AISI 304
- succheruola in acciaio inox AISI 304
- viteria in acciaio inox AISI 304

CARATTERISTICHE:

- portata massima: 1050 l/m
- prevalenza massima: 842 metri
- potenza massima: 45 Kw
- diametro d'ingombro massimo: 145 mm (incluso il copri cavo)
- temperatura massima dell'acqua: 35°C (solo per la pompa, per il motore vedi catalogo motori)
- contenuto di sabbia massimo: 60 g/m³



6" pumps type FB6R, are for clean water for 6" wells DN 150. The suction support and the delivery bowl are in micro-cast AISI 304 stainless steel.

To assure greater safety to the pump, even in deep wells (more than 40 bar), a new system has been projected to lighten the pressure on the impellers: a single pump becomes a group of two pumps in series, named FB6R.../...D.

APPLICATIONS:

- irrigation
- water supply system
- pressure boosting
- fire-fighting systems

CONSTRUCTION:

- micro-cast stainless steel AISI 304 suction support and delivery bowl
- stainless steel AISI 304 non-return valve
- stainless steel AISI 304 external sleeve
- stainless steel AISI 420 shaft
- noryl impellers
- noryl diffusers
- stainless steel AISI 304 interstage diffuser casing
- stainless steel AISI 304 cable cover
- stainless steel AISI 304 suction strainer
- stainless steel AISI 304 nuts, bolts and screws

FEATURES:

- maximum capacity: 1050 l/m
- maximum head: 842 meters
- maximum power: 45 Kw
- maximum encumbrance diameter: 145 mm (cable cover included)
- maximum water temperature: 35°C (only for the pump, for the motor see motors' catalogue)
- maximum sand content: 60 g/m³



Les électropompes immergées 6", de la série FB6R, sont pour eau propres pour des puits de 6" DN 150.

L'orifice de refoulement et le support d'aspiration sont en acier moulé en AISI 304.

Pour assurer sécurité à la pompe dans les grandes profondeurs (plus de 40 bar), à été mis en place un nouveau système pour alléger la pression sur les roues, la seule pompe devient un groupe de deux pompes en série, identifié par le modèle FB6R.../...D.

APPLICATIONS:

- irrigation
- installation d'approvisionnement hydrique
- surpression
- anti incendie

CONSTRUCTION:

- support d'aspiration et orifice de refoulement en acier moulé AISI 304
- clapet de retenue en acier AISI 304
- manteau extérieur en acier AISI 304
- arbre en acier inox AISI 420
- roues en noryl
- diffuseurs en noryl
- tuyau d'espacement en acier inox AISI 304
- couvre-câble en acier AISI 304
- grille d'aspiration en acier AISI 304
- visserie en acier AISI 304

CARACTERISTIQUES:

- débit maximum: 1050 l/m
- hauteur maximale: 842 mètres
- puissance maximale: 45 Kw
- diamètre d'encombrement maximum: 145 mm (inclus le couvre-câble)
- température maximale de l'eau: 35°C (pour la pompe, pour le moteur voir le catalogue des moteurs)
- quantité maximale de sable: 60 g/m³

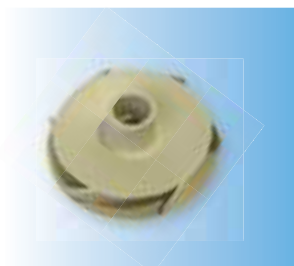

SPACCATO 6"

6" CUTAWAY
COUPE 6"

FB6R

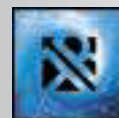

N°	Descrizione Description Description	Materiale Material Matériel
1	Supporto di aspirazione Suction Support Support d'Aspiration	AISI 304
2	Giunto di Traino Joint Joint	AISI 304
3	Rondella di spallamento Counter thrust bearing washer Plateau de contre-butée	AISI 304
5	Camicia albero Bearing sleeve Chemise arbre	AISI 304
6	Supporto lato aspirazione Lower support Paller de guide Inferlor	noryl + bronzo noryl + bronze noryl + bronze
7	Disco Disc Disque	noryl noryl noryl
8	Bussola distanziatrice Spacer sleeve Douille entretoise	noryl noryl noryl
9	Camicia albero Bearing sleeve Chemise arbre	AISI 304 + ceramica AISI 304 + ceramic AISI 304 + céramique
10	Camera premente Discharge casing Corps de refolement	noryl + gomma noryl + rubber noryl + coutchouc
11	Disco Disc Disque	noryl noryl noryl
12	Diffusore Diffuser Diffuseur	noryl noryl noryl
13	Girante Impeller Roue	noryl noryl noryl
14	Tubo distanziale Interstage diffuser casing Entrotoise	AISI 304
15	Bussola distanziatrice Spacer sleeve Douille entretoise	noryl noryl noryl
16	Camicia albero Bearing sleeve Chemise arbre	AISI 304 + ceramica AISI 304 + ceramic AISI 304 + céramique
17	Camera premente Discharge casing Corps de refolement	noryl + gomma noryl + rubber noryl + coutchouc
18	Otturatore valvola Wing valve Soupape du clapet de retenue	AISI 304
19	Mandata Delivery Bowl Refolement	AISI 304

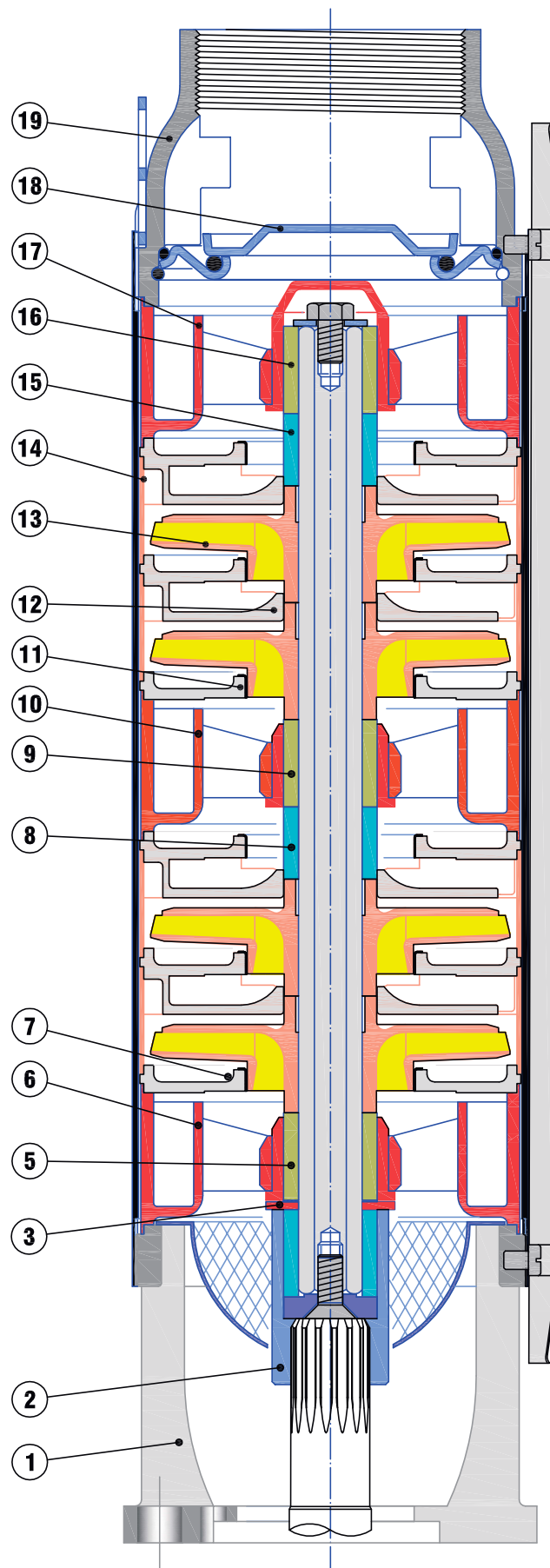



TABELLA DELLE CARATTERISTICHE IDRAULICHE 6"

6" HYDRAULIC FEATURES' CHART

TABLE DES CARACTÉRISTIQUES HYDRAULIQUES 6"

Tipo Type Type	Motore Motor Moteur		Q = Portata - Capacity - Débit																				
			l/sec	0	0,8	1,3	1,7	2,1	2,5	2,9	3,3	3,8	4,2	4,6	5	5,8	6,7	7,5	8,3				
				l/min	0	50	75	100	125	150	175	200	225	250	275	300	350	400	450	500			
			mc/h		0	3	4,5	6	7,5	9	10,5	12	13,5	15	16,5	18	21	24	27	30			
FB6RB/5	3	2,2		78	73	70	67	63	58	53	46	37	27										
FB6RB/7	4	3		109	102	98	94	89	82	74	64	52	38										
FB6RB/9	5,5	4		140	131	126	121	114	105	95	82	67	48										
FB6RB/12	7,5	5,5		187	175	169	161	152	140	127	109	89	65										
FB6RB/16	10	7,5		250	234	225	214	202	187	169	146	118	86										
FB6RB/21	12,5	9,2		328	307	295	281	266	245	222	192	155	113										
FB6RB/24	15	11	H(m)	374	350	337	322	304	280	253	219	178	129										
FB6RB/28	17,5	13		437	409	393	375	354	327	295	255	207	151										
FB6RB/32D	20	15		499	467	450	429	405	374	338	292	237	172										
FB6RB/40D	25	18,5		624	584	562	536	506	467	422	365	296	215										
FB6RB/48D	30	22		749	701	674	643	607	561	506	438	355	258										
FB6RB/54D	35	26		842	788	759	724	683	631	570	492	400	291										
FB6RD/5	4	3		79			75	74	71	68	64	58	52	45	37	15							
FB6RD/6	5,5	4		94			90	88	86	81	76	70	63	54	44	17							
FB6RD/9	7,5	5,5		141			136	133	128	122	115	105	94	81	66	26							
FB6RD/12	10	7,5		188			181	177	171	163	153	140	125	108	88	35							
FB6RD/15	12,5	9,2		236			226	221	214	204	191	175	156	135	110	44							
FB6RD/18	15	11		283			271	265	257	244	229	210	188	162	131	52							
FB6RD/21	17,5	13	H(m)	330			317	309	299	285	267	245	219	189	153	61							
FB6RD/24	20	15		377			362	354	342	326	306	280	250	216	175	70							
FB6RD/30	25	18,5		471			452	442	428	407	382	350	313	269	219	87							
FB6RD/35D	30	22		550			528	516	499	475	446	408	365	314	256	102							
FB6RD/40D	35	26		628			603	589	570	543	509	466	417	359	292	116							
FB6RD/45D	40	30		707			679	663	641	611	573	524	469	404	329	131							
FB6RD/52D	50	37		816			784	766	741	706	662	606	542	467	380	151							
FB6RE/4	4	3		56					50	49	47	46	44	42	40	36	31	26	20				
FB6RE/5	5,5	4		70					63	61	59	57	55	53	50	45	39	32	25				
FB6RE/7	7,5	5,5		98					88	86	83	80	77	74	70	63	54	45	35				
FB6RE/10	10	7,5		140					125	122	118	114	110	105	100	89	77	64	50				
FB6RE/12	12,5	9,2		168					150	147	142	137	132	126	120	107	93	77	60				
FB6RE/15	15	11		210					188	183	177	171	164	158	150	134	116	96	75				
FB6RE/17	17,5	13		238					213	208	201	194	187	179	170	152	131	109	85				
FB6RE/20	20	15	H(m)	280					251	244	236	228	219	210	200	178	154	128	100				
FB6RE/25	25	18,5		350					314	305	296	285	274	263	250	223	193	160	125				
FB6RE/30D	30	22		420					376	366	355	342	329	315	300	268	232	192	149				
FB6RE/35D	35	26		490					439	427	414	399	383	368	350	312	270	224	174				
FB6RE/40D	40	30		560					502	488	473	456	438	420	400	357	309	256	199				
FB6RE/50D	50	37		700					627	610	591	571	548	525	500	446	386	320	249				
FB6RE/58D	60	45		812					727	707	686	602	635	609	579	517	448	371	289				

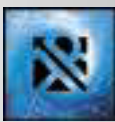
TABELLA DELLE CARATTERISTICHE IDRAULICHE 6"

6" HYDRAULIC FEATURES' CHART

TABLE DES CARACTÉRISTIQUES HYDRAULIQUES 6"

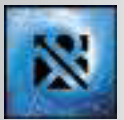

n=2900 1/min 50 Hz

Tipo Type Type	Motore Motor Moteur		Q = Portata - Capacity - Débit																			
			l/sec	0	3,3	4,2	5	5,8	6,7	7,5	8,3	9,2	10	10,8	11,7	12,5	13,3	14,2	15	15,8	16,7	17,5
			l/min	0	200	250	300	350	400	450	500	550	600	650	700	750	800	850	900	950	1000	1050
			mc/h	0	12	15	18	21	24	27	30	33	36	39	42	45	48	51	54	57	60	63
Hp	Kw	H(m)																				
FB6RF/3	4	3	46	40	38	35	32	29	25	21	16	14	4									
FB6RF/4	5,5	4	61	53	50	47	43	39	33	27	21	13	5									
FB6RF/6	7,5	5,5	92	79	75	70	65	58	50	41	31	20	8									
FB6RF/8	10	7,5	122	106	100	94	86	77	67	55	42	27	11									
FB6RF/10	12,5	9,2	153	132	125	117	108	97	84	69	52	34	14									
FB6RF/12	15	11	184	159	150	141	129	116	100	82	63	40	16									
FB6RF/14	17,5	13	214	185	175	164	151	135	117	96	73	47	19									
FB6RF/16	20	15	245	212	200	187	172	154	134	110	83	54	22									
FB6RF/20	25	18,5	306	264	251	234	215	193	167	137	104	67	27									
FB6RF/24	30	22	367	317	301	281	258	232	200	164	125	81	32									
FB6RF/28D	35	26	428	370	351	328	301	270	234	192	146	94	38									
FB6RF/32D	40	30	490	423	401	375	344	309	267	219	167	108	43									
FB6RF/40D	50	37	612	529	501	468	430	386	334	274	208	134	54									
FB6RF/46D	60	45	704	608	576	539	495	444	384	315	240	155	62									
FB6RH/2	4	3	31			28	27	26	25	23	22	19	16	13	10	7	3					
FB6RH/3	5,5	4	47			42	40	39	37	35	32	28	24	20	15	10	4					
FB6RH/4	7,5	5,5	62			55	54	52	49	46	42	38	32	26	20	13	6					
FB6RH/5	10	7,5	78			69	67	65	62	58	53	47	40	33	25	17	7					
FB6RH/6	12,5	9,2	93			83	81	78	74	70	64	57	48	39	30	20	8					
FB6RH/8	15	11	124			111	108	104	99	93	85	76	65	53	40	26	11					
FB6RH/9	17,5	13	140			125	121	117	111	104	96	85	73	59	45	30	13					
FB6RH/10	20	15	155			139	135	130	124	116	106	95	81	66	50	33	14					
FB6RH/13	25	18,5	202			180	175	169	161	151	138	123	105	86	64	43	18					
FB6RH/16	30	22	248			222	216	208	198	186	170	151	129	105	79	53	22					
FB6RH/19	35	26	295			264	256	246	235	220	202	180	154	125	94	63	27					
FB6RH/22	40	30	341			305	296	285	272	255	234	208	178	145	109	73	31					
FB6RH/27D	50	37	419			374	364	350	334	313	287	255	218	178	134	89	38					
FB6RH/32D	60	45	496			444	431	415	396	371	340	302	259	211	158	106	45					
FB6RL/2	5,5	4	26						23	22	21	19	18	17	15	14	13	12	11	9	7	5
FB6RL/3	7,5	5,5	39						35	34	32	29	27	25	23	21	20	18	16	14	11	7
FB6RL/4	10	7,5	52						47	45	42	39	36	33	31	28	26	24	21	18	14	9
FB6RL/6	12,5	9,2	77						70	68	63	58	54	50	46	43	39	36	32	27	21	14
FB6RL/7	15	11	90						82	79	74	68	63	58	54	50	46	42	37	32	25	16
FB6RL/8	17,5	13	103						93	90	84	78	72	66	61	57	53	48	43	36	28	18
FB6RL/9	20	15	116						105	101	95	88	81	75	69	64	59	54	48	41	32	21
FB6RL/12	25	18,5	155						140	135	126	117	107	99	92	85	79	72	64	54	42	28
FB6RL/14	30	22	181						163	158	147	136	125	116	108	100	92	84	74	63	49	32
FB6RL/17	35	26	219						198	191	179	165	152	141	131	121	112	102	90	77	60	39
FB6RL/19	40	30	245						221	214	200	185	170	157	146	135	125	114	101	86	67	44
FB6RL/24D	50	37	310						280	270	252	234	215	199	184	171	158	144	128	108	84	55
FB6RL/28D	60	45	361						326	315	294	272	251	232	215	199	184	168	149	126	98	64

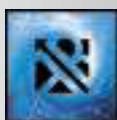

Tipo Type Type	Motore Motors 2900 g/m Moteurs		Q = Portata - Capacity - Débit									
	Cv Hp	Kw	l/sec	0	1,3	1,7	2,1	2,5	2,9	3,3	3,8	4,2
			l/min	0	75	100	125	150	175	200	225	250
			mc/h	0	4,5	6	7,5	9	10,5	12	13,5	15
FB6RB/5 + 4B3	3	2,2	H(m)	78	70	67	63	58	53	46	37	27
FB6RB/7 + 4B4	4	3		109	98	94	89	82	74	64	52	38
FB6RB/9 + 6F5	5,5	4		140	126	121	114	105	95	82	67	48
FB6RB/12 + 6F7	7,5	5,5		187	169	161	152	140	127	109	89	65
FB6RB/16 + 6F10	10	7,5		250	225	214	202	187	169	146	118	86
FB6RB/21 + 6F12	12,5	9,2		328	295	281	266	245	222	192	155	113
FB6RB/24 + 6F15	15	11		374	337	322	304	280	253	219	178	129
FB6RB/28 + 6F17	17,5	13		437	393	375	354	327	295	255	207	151
FB6RB/32D + 6F20*	20	15		499	450	429	405	374	338	292	237	172
FB6RB/40D + 6F25*	25	18,5		624	562	536	506	467	422	365	296	215
FB6RB/48D + 6F30*	30	22		749	674	643	607	561	506	438	355	258
FB6RB/54D + 6F35*	35	26		842	759	724	683	631	570	492	400	291

Dimensioni e pesi

Overall dimensions and weights - Dimensions d'encombrement et poids

Tipo Type Type	Cv Hp	Kw	A (mm)	B (mm)	C (mm)	D (mm)	ø max (mm)	DN	Peso - Weight - Poids		
									A (kg)	B (kg)	C (kg)
FB6RB/5+ 4B3	3	2,2	930	478	452	145	140	G 3"	22	10	12
FB6RB/7 + 4B4	4	3	1061	554	507				26	11	15
FB6RB/9 + 6F5	5,5	4	1227	630	597				57	13	44
FB6RB/12 + 6F7	7,5	5,5	1371	744	627				61	15	46
FB6RB/16 + 6F10	10	7,5	1525	858	667				67	17	50
FB6RB/21 + 6F12	12,5	9,2	1783	1086	697				76	22	54
FB6RB/24 + 6F15	15	11	1967	1200	767				85	24	61
FB6RB/28 + 6F17	17,5	13	2171	1404	767				90	28	62
FB6RB/32D + 6F20*	20	15	2520	1693	827				109	41	68
FB6RB/40D + 6F25*	25	18,5	2894	1997	897				123	48	75
FB6RB/48D + 6F30*	30	22	3268	2301	967				136	54	82
FB6RB/54D + 6F35*	35	26	3536	2509	1027				148	59	89



* Non consigliata per montaggio in posizione orizzontale

* This electropump isn't recommended for horizontal assemblage

* Cette électropompe n'est pas recommandée pour le montage en position horizontale

CURVE DELLE PRESTAZIONI

PERFORMANCES' CURVES

COURBES DES PERFORMANCES

FB6RB

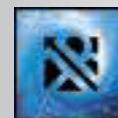

n=2900 1/min 50 Hz

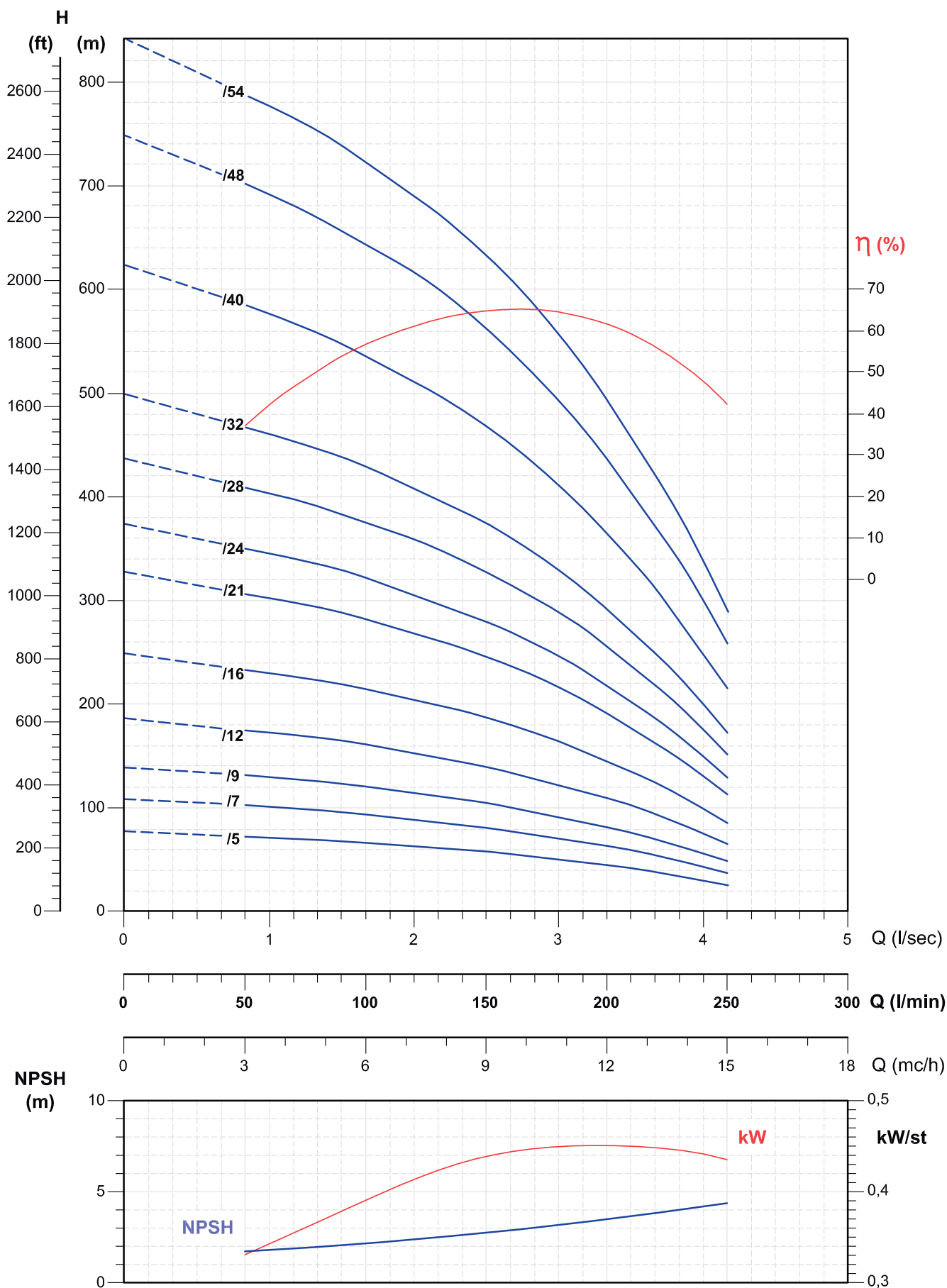

Tolleranze secondo EN ISO 9906 app.A Gr.2 - Tolerances according to EN ISO 9906 anx.A Gr.2 - Tolérances conformes EN ISO 9906 ann.A Gr.2
 Rispetta il Reg. UE n° 547/2012 con MEI = 0.40 - Comply with Reg. UE n° 547/2012 with MEI = 0.40 - Conforme Reg. UE n°547/2012 avec MEI =0.40

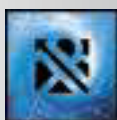

Tipo Type Type	Motore Motors 2900 g/m Moteurs		Q = Portata - Capacity - Débit									
	Cv Hp	Kw	l/sec	0	2,5	2,9	3,3	3,8	4,2	4,6	5	5,8
			l/min	0	150	175	200	225	250	275	300	350
			mc/h	0	9	10,5	12	13,5	15	16,5	18	21
FB6RD/5 + 4B4	4	3	H(m)	79	71	68	64	58	52	45	37	15
FB6RD/6 + 6F5	5,5	4		94	86	81	76	70	63	54	44	17
FB6RD/9 + 6F7	7,5	5,5		141	128	122	115	105	94	81	66	26
FB6RD/12 + 6F10	10	7,5		188	171	163	153	140	125	108	88	35
FB6RD/15 + 6F12	12,5	9,2		236	214	204	191	175	156	135	110	44
FB6RD/18 + 6F15	15	11		283	257	244	229	210	188	162	131	52
FB6RD/21 + 6F17	17,5	13		330	299	285	267	245	219	189	153	61
FB6RD/24 + 6F20	20	15		377	342	326	306	280	250	216	175	70
FB6RD/30 + 6F25	25	18,5		471	428	407	382	350	313	269	219	87
FB6RD/35D + 6F30*	30	22		550	499	475	446	408	365	314	256	102
FB6RD/40D + 6F35*	35	26		628	570	543	509	466	417	359	292	116
FB6RD/45D + 6F40*	40	30		707	641	611	573	524	469	404	329	131
FB6RD/52D + 6F50*	50	37		816	741	706	662	606	542	467	380	151

Dimensioni e pesi

Overall dimensions and weights - Dimensions d'encombrement et poids

Tipo Type Type	Cv Hp	Kw	A (mm)	B (mm)	C (mm)	D (mm)	ø max (mm)	DN	Peso - Weight - Poids		
									A (kg)	B (kg)	C (kg)
FB6RD/5 + 4B4	4	3	983	478	505	94	140	G 3"	25	10	15
FB6RD/6 + 6F5	5,5	4	1113	516	597	145	145		55	11	44
FB6RD/9 + 6F7	7,5	5,5	1257	630	627				59	13	46
FB6RD/12 + 6F10	10	7,5	1411	744	667				65	15	50
FB6RD/15 + 6F12	12,5	9,2	1555	858	697				71	17	54
FB6RD/18 + 6F15	15	11	1739	972	767				79	18	61
FB6RD/21 + 6F17	17,5	13	1853	1086	767				84	22	62
FB6RD/24 + 6F20	20	15	2027	1200	827				92	24	68
FB6RD/30 + 6F25	25	18,5	2377	1480	897				104	29	75
FB6RD/35D + 6F30*	30	22	2774	1807	967				125	43	82
FB6RD/40D + 6F35*	35	26	3024	1997	1027				136	47	89
FB6RD/45D + 6F40*	40	30	3354	2187	1167				154	51	103
FB6RD/52D + 6F50*	50	37	3750	2453	1297				173	57	116



* Non consigliata per montaggio in posizione orizzontale

* This electropump isn't recommended for horizontal assemblage

* Cette électropompe n'est pas recommandée pour le montage en position horizontale

CURVE DELLE PRESTAZIONI

PERFORMANCES' CURVES

COURBES DES PERFORMANCES

FB6RD

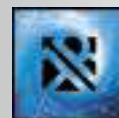

n=2900 1/min 50 Hz

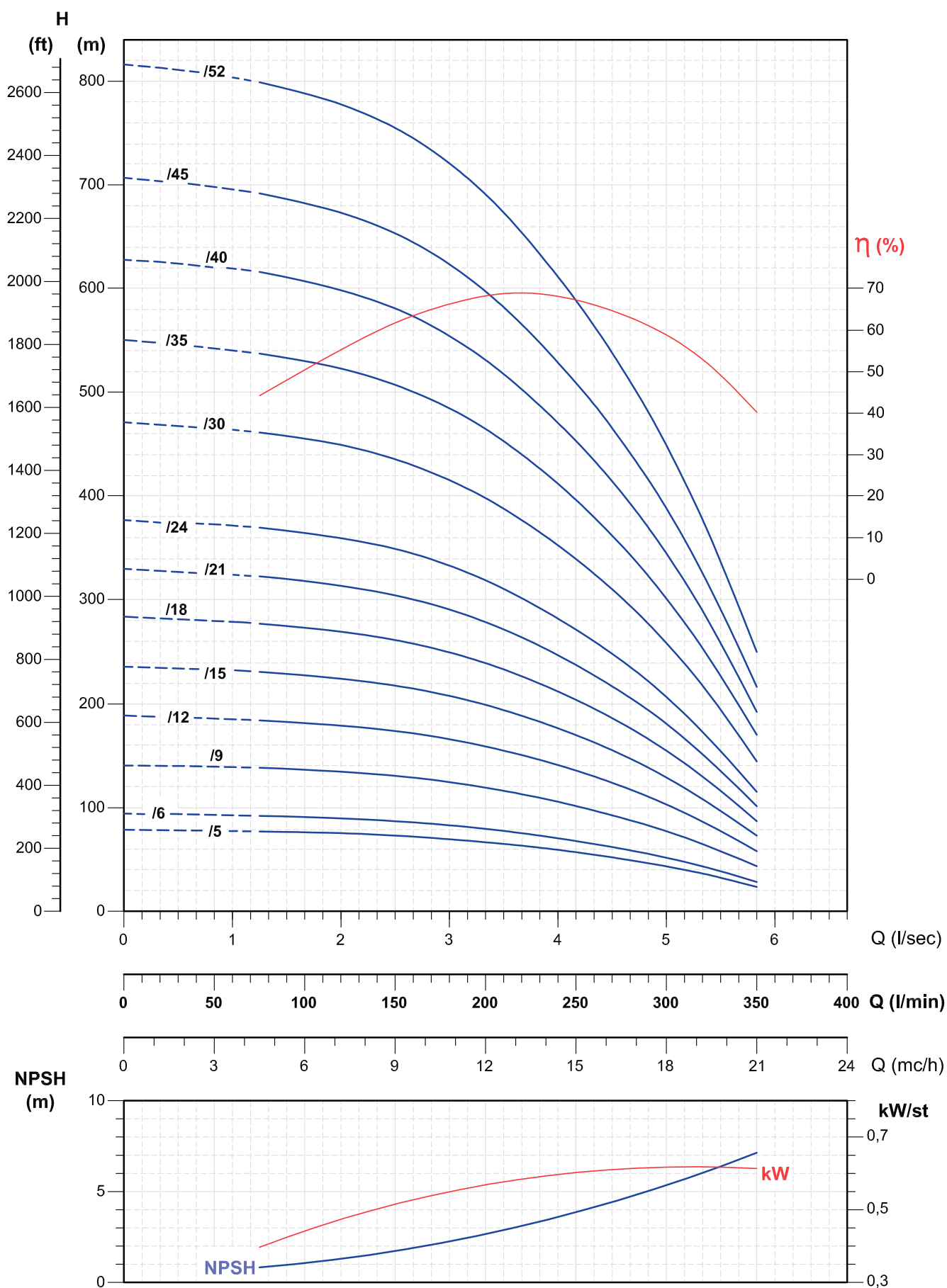

Tolleranze secondo EN ISO 9906 app.A Gr.2 - Tolerances according to EN ISO 9906 anx.A Gr.2 - Tolérances conformes EN ISO 9906 ann.A Gr.2
 Rispetta il Reg. UE n° 547/2012 con MEI = 0.40 - Comply with Reg. UE n° 547/2012 with MEI = 0.40 - Conforme Reg. UE n°547/2012 avec MEI =0.40

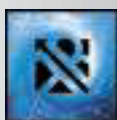

Tipo Type Type	Motore Motors 2900 g/m Moteurs		Q = Portata - Capacity - Débit									
	Cv Hp	Kw	l/sec	0	2,5	3,3	4,2	5	5,8	6,7	7,5	8,3
			l/min	0	150	200	250	300	350	400	450	500
			mc/h	0	9	12	15	18	21	24	27	30
FB6RE/4 + 4B4	4	3	H(m)	56	50	47	44	40	36	31	26	20
FB6RE/5 + 6F5	5,5	4		70	63	59	55	50	45	39	32	25
FB6RE/7 + 6F7	7,5	5,5		98	88	83	77	70	63	54	45	35
FB6RE/10 + 6F10	10	7,5		140	125	118	110	100	89	77	64	50
FB6RE/12 + 6F12	12,5	9,2		168	150	142	132	120	107	93	77	60
FB6RE/15 + 6F15	15	11		210	188	177	164	150	134	116	96	75
FB6RE/17 + 6F17	17,5	13		238	213	201	187	170	152	131	109	85
FB6RE/20 + 6F20	20	15		280	251	236	219	200	178	154	128	100
FB6RE/25 + 6F25	25	18,5		350	314	296	274	250	223	193	160	125
FB6RE/30D + 6F30*	30	22		420	376	355	329	300	268	232	192	149
FB6RE/35D + 6F35*	35	26		490	439	414	383	350	312	270	224	174
FB6RE/40D + 6F40*	40	30		560	502	473	438	400	357	309	256	199
FB6RE/50D + 6F50*	50	37		700	627	591	548	500	446	386	320	249
FB6RE/58D + 6F60*	60	45		812	727	686	635	579	517	448	371	289



Dimensioni e pesi

Overall dimensions and weights - Dimensions d'encombrement et poids

Tipo Type Type	Cv Hp	Kw	A (mm)	B (mm)	C (mm)	D (mm)	ø max (mm)	DN	Peso - Weight - Poids		
									A (kg)	B (kg)	C (kg)
FB6RE/4 + 4B4	4	3	1021	516	505	94	140		26	11	15
FB6RE/5 + 6F5	5,5	4	1170	573	597				55	11	44
FB6RE/7 + 6F7	7,5	5,5	1314	687	627				60	14	46
FB6RE/10 + 6F10	10	7,5	1525	858	667				67	17	50
FB6RE/12 + 6F12	12,5	9,2	1669	972	697				73	19	54
FB6RE/15 + 6F15	15	11	1910	1143	767				84	23	61
FB6RE/17 + 6F17	17,5	13	2024	1257	767				87	25	62
FB6RE/20 + 6F20	20	15	2307	1480	827	145	145	G 3"	92	24	68
FB6RE/25 + 6F25	25	18,5	2661	1764	897				108	33	75
FB6RE/30D + 6F30*	30	22	3154	2187	967				131	49	82
FB6RE/35D + 6F35*	35	26	3499	2472	1027				144	55	89
FB6RE/40D + 6F40*	40	30	4028	2861	1167				166	63	103
FB6RE/50D + 6F50*	50	37	4728	3431	1297				190	74	116
FB6RE/58D + 6F60*	60	45	5100	3773	1327				202	81	121

* Non consigliata per montaggio in posizione orizzontale

* This electropump isn't recommended for horizontal assemblage

* Cette électropompe n'est pas recommandée pour le montage en position horizontale

CURVE DELLE PRESTAZIONI

PERFORMANCES' CURVES

COURBES DES PERFORMANCES

FB6RE

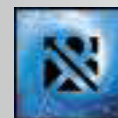

n=2900 1/min 50 Hz

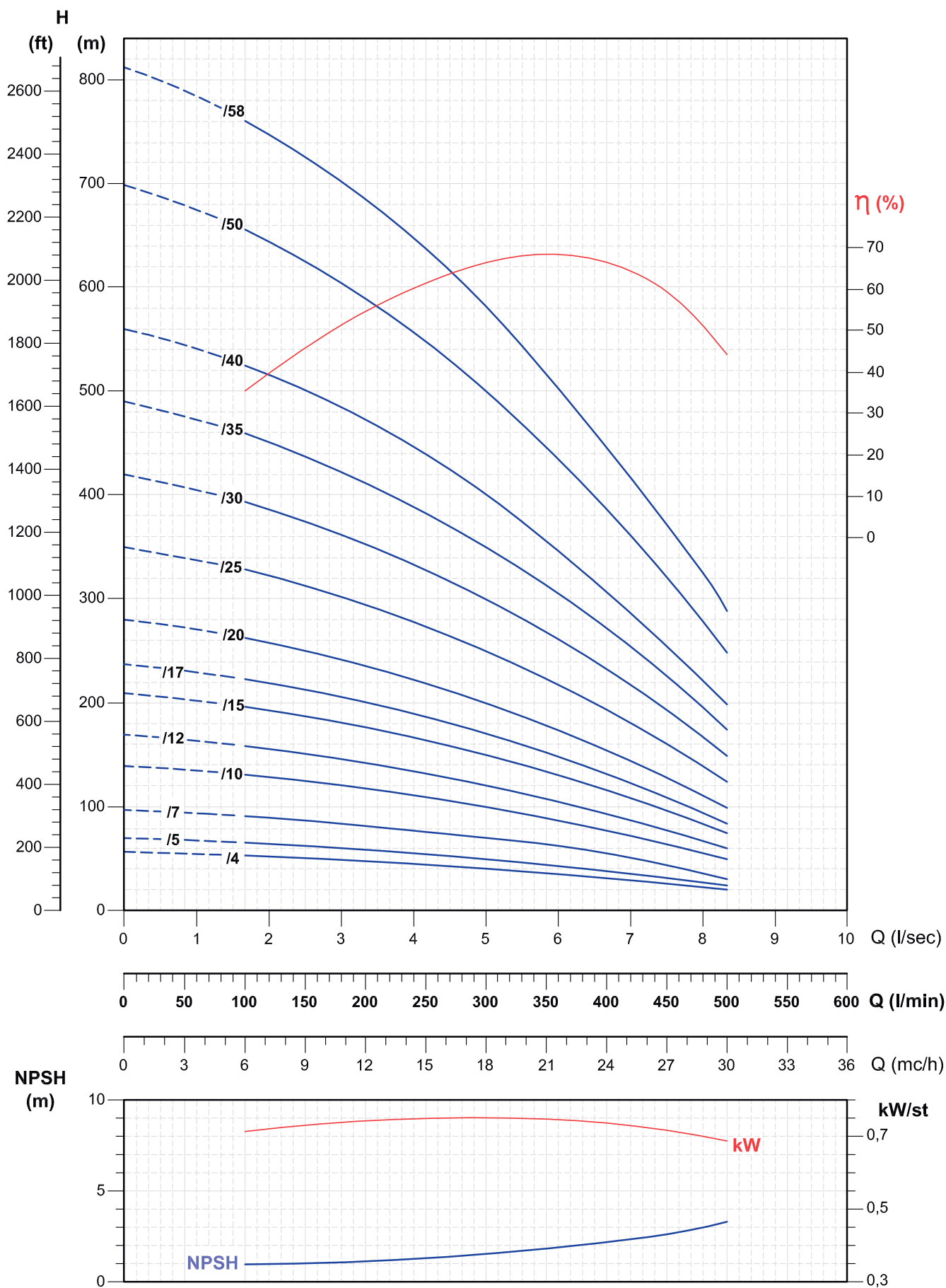

Tolleranze secondo EN ISO 9906 app.A Gr.2 - Tolerances according to EN ISO 9906 anx.A Gr.2 - Tolérances conformes EN ISO 9906 ann.A Gr.2
 Rispetta il Reg. UE n° 547/2012 con MEI = 0.40 - Comply with Reg. UE n° 547/2012 with MEI = 0.40 - Conforme Reg. UE n°547/2012 avec MEI=0.40

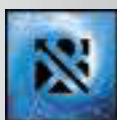

Tipo Type Type	Motore Motors 2900 g/m Moteurs		Q = Portata - Capacity - Débit									
			l/sec	0	2,1	3,3	4,6	5,8	7,1	8,3	9,6	10,8
	Cv Hp	Kw	l/min	0	125	200	275	350	425	500	575	650
			mc/h	0	7,5	12	16,5	21	25,5	30	34,5	39
FB6RF/3 + 4B4	4	3	H(m)	46	43	40	36	32	28	21	15	4
FB6RF/4 + 6F5	5,5	4	61	58	53	49	43	37	27	18	5	
FB6RF/6 + 6F7	7,5	5,5	92	85	79	73	65	58	41	25	8	
FB6RF/8 + 6F10	10	7,5	122	116	106	97	86	78	55	38	11	
FB6RF/10 + 6F12	12,5	9,2	153	141	132	121	108	98	69	47	14	
FB6RF/12 + 6F15	15	11	184	175	159	146	129	118	82	58	16	
FB6RF/14 + 6F17	17,5	13	214	200	185	170	151	137	96	66	19	
FB6RF/16 + 6F20	20	15	245	229	212	194	172	156	110	74	22	
FB6RF/20 + 6F25	25	18,5	306	283	264	243	215	193	137	97	27	
FB6RF/24 + 6F30	30	22	367	342	317	291	258	230	164	122	32	
FB6RF/28D + 6F35*	35	26	428	400	370	340	301	270	192	140	38	
FB6RF/32D + 6F40*	40	30	490	458	423	388	344	304	219	162	43	
FB6RF/40D + 6F50*	50	37	612	570	529	486	430	385	274	202	54	
FB6RF/46D + 6F60*	60	45	704	657	608	558	495	440	315	232	62	

Dimensioni e pesi

Overall dimensions and weights - Dimensions d'encombrement et poids

Tipo Type Type	Cv Hp	Kw	A (mm)	B (mm)	C (mm)	D (mm)	ø max (mm)	DN	Peso - Weight - Poids		
									A (kg)	B (kg)	C (kg)
FB6RF/3 + 4B4	4	3	964	459	505	94	140	G 3"	25	10	15
FB6RF/4 + 6F5	5,5	4	1113	516	597	145	145		55	11	44
FB6RF/6 + 6F7	7,5	5,5	1257	630	627				59	13	46
FB6RF/8 + 6F10	10	7,5	1411	744	667				65	15	50
FB6RF/10 + 6F12	12,5	9,2	1555	858	697				71	17	54
FB6RF/12 + 6F15	15	11	1739	972	767				80	19	61
FB6RF/14 + 6F17	17,5	13	1853	1086	767				84	22	62
FB6RF/16 + 6F20	20	15	2027	1200	827				92	24	68
FB6RF/20 + 6F25	25	18,5	2377	1480	897				103	28	75
FB6RF/24 + 6F30	30	22	2674	1707	967				114	32	82
FB6RF/28D + 6F35*	35	26	3100	2073	1027				136	47	89
FB6RF/32D + 6F40*	40	30	3468	2301	1167				154	51	103
FB6RF/40D + 6F50*	50	37	4054	2757	1297				176	60	116
FB6RF/46D + 6F60*	60	45	4426	3099	1327				187	66	121



* Non consigliata per montaggio in posizione orizzontale

* This electropump isn't recommended for horizontal assemblage

* Cette électropompe n'est pas recommandée pour le montage en position horizontale

CURVE DELLE PRESTAZIONI

PERFORMANCES' CURVES
COURBES DES PERFORMANCES

FB6RF

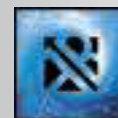

n=2900 1/min 50 Hz

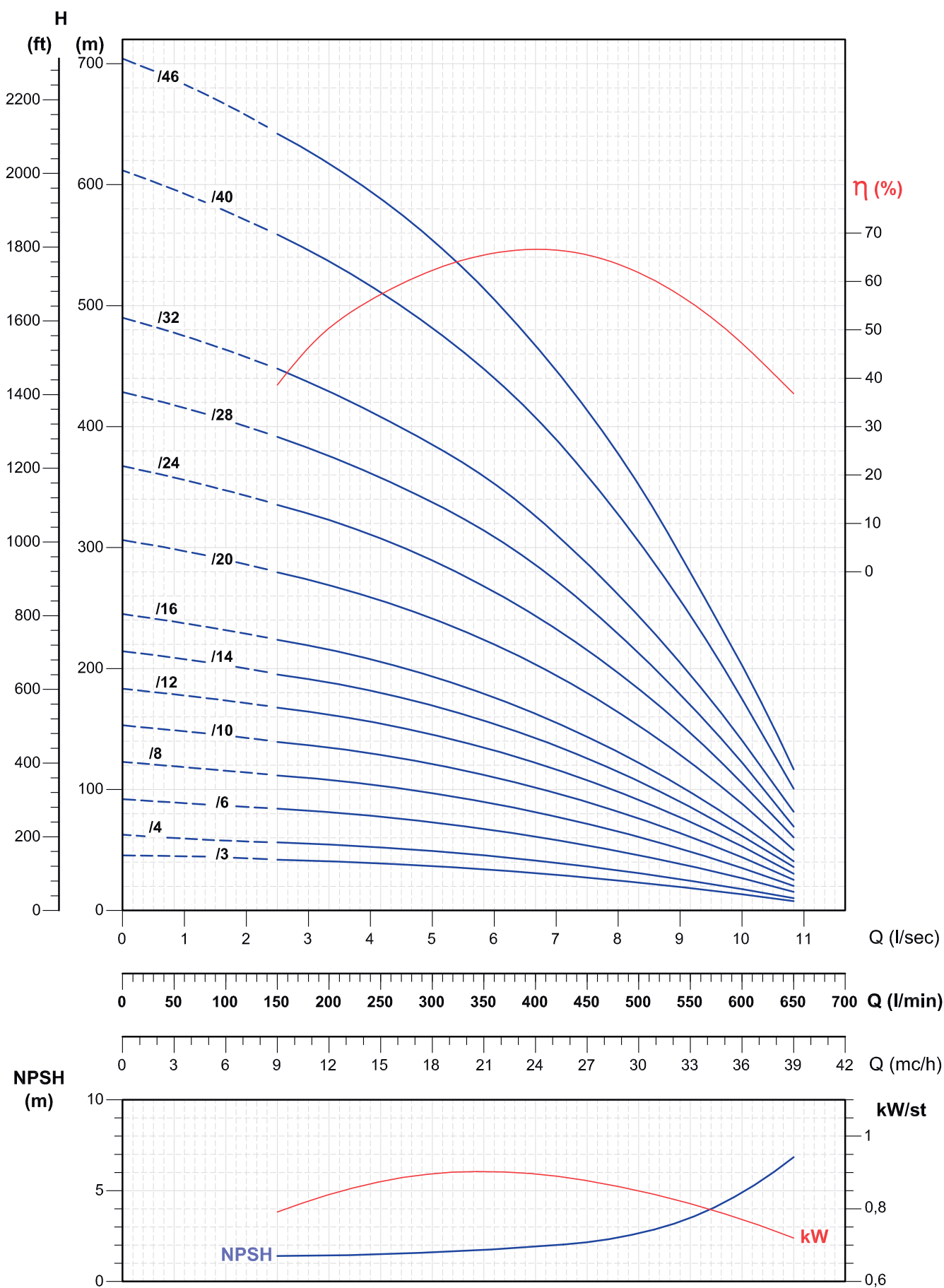

Tolleranze secondo EN ISO 9906 app.A Gr.2 - Tolerances according to EN ISO 9906 annex A Gr.2 - Tolérances conformes EN ISO 9906 ann.A Gr.2

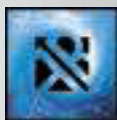

Tipo Type Type	Motore Motors 2900 g/m Moteurs		Q = Portata - Capacity - Débit									
	Cv Hp	Kw	l/sec	0	2,5	4,2	5,8	7,5	9,2	10,8	12,5	14,2
			l/min	0	150	250	350	450	550	650	750	850
			mc/h	0	9	15	21	27	33	39	45	51
FB6RH/2 + 4B4	4	3	H(m)	31	30	29	27	25	21	16	10	3
FB6RH/3 + 6F5	5,5	4	47	44	42	40	37	32	24	15	4	
FB6RH/4 + 6F7	7,5	5,5	62	59	57	54	49	42	32	20	6	
FB6RH/5 + 6F10	10	7,5	78	75	70	67	62	53	40	25	7	
FB6RH/6 + 6F12	12,5	9,2	93	90	85	81	74	64	48	30	8	
FB6RH/8 + 6F15	15	11	124	119	114	108	99	85	65	40	11	
FB6RH/9 + 6F17	17,5	13	140	134	128	121	111	96	73	45	13	
FB6RH/10 + 6F20	20	15	155	148	143	135	124	106	81	50	14	
FB6RH/13 + 6F25	25	18,5	202	195	186	175	161	138	105	64	18	
FB6RH/16 + 6F30	30	22	248	238	229	216	198	170	129	79	22	
FB6RH/19 + 6F35	35	26	295	283	273	256	235	202	154	94	27	
FB6RH/22 + 6F40	40	30	341	326	316	296	272	234	178	109	31	
FB6RH/27D + 6F50*	50	37	419	401	388	364	334	287	218	134	38	
FB6RH/32D + 6F60*	60	45	496	476	458	431	396	340	259	158	45	

Dimensioni e pesi

Overall dimensions and weights - Dimensions d'encombrement et poids

Tipo Type Type	Cv Hp	Kw	A (mm)	B (mm)	C (mm)	D (mm)	ø max (mm)	DN	Peso - Weight - Poids				
									A (kg)	B (kg)	C (kg)		
FB6RH/2 + 4B4	4	3	913	408	505	94	140	145	145	G 3"	24	9	15
FB6RH/3 + 6F5	5,5	4	1065	468	597						54	10	44
FB6RH/4 + 6F7	7,5	5,5	1155	528	627						57	11	46
FB6RH/5 + 6F10	10	7,5	1255	588	667						61	11	50
FB6RH/6 + 6F12	12,5	9,2	1345	648	697						66	12	54
FB6RH/8 + 6F15	15	11	1535	768	767						75	14	61
FB6RH/9 + 6F17	17,5	13	1595	828	767						77	15	62
FB6RH/10 + 6F20	20	15	1715	888	827						84	16	68
FB6RH/13 + 6F25	25	18,5	1965	1068	897						94	19	75
FB6RH/16 + 6F30	30	22	2215	1248	967						104	22	82
FB6RH/19 + 6F35	35	26	2507	1480	1027						117	28	89
FB6RH/22 + 6F40	40	30	2827	1660	1167						134	31	103
FB6RH/27D + 6F50*	50	37	3256	1959	1297						157	41	116
FB6RH/32D + 6F60*	60	45	3724	2397	1327						174	53	121



* Non consigliata per montaggio in posizione orizzontale

* This electropump isn't recommended for horizontal assemblage

* Cette électropompe n'est pas recommandée pour le montage en position horizontale

CURVE DELLE PRESTAZIONI

PERFORMANCES' CURVES

COURBES DES PERFORMANCES

FB6RH

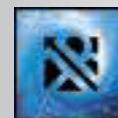

n=2900 1/min 50 Hz

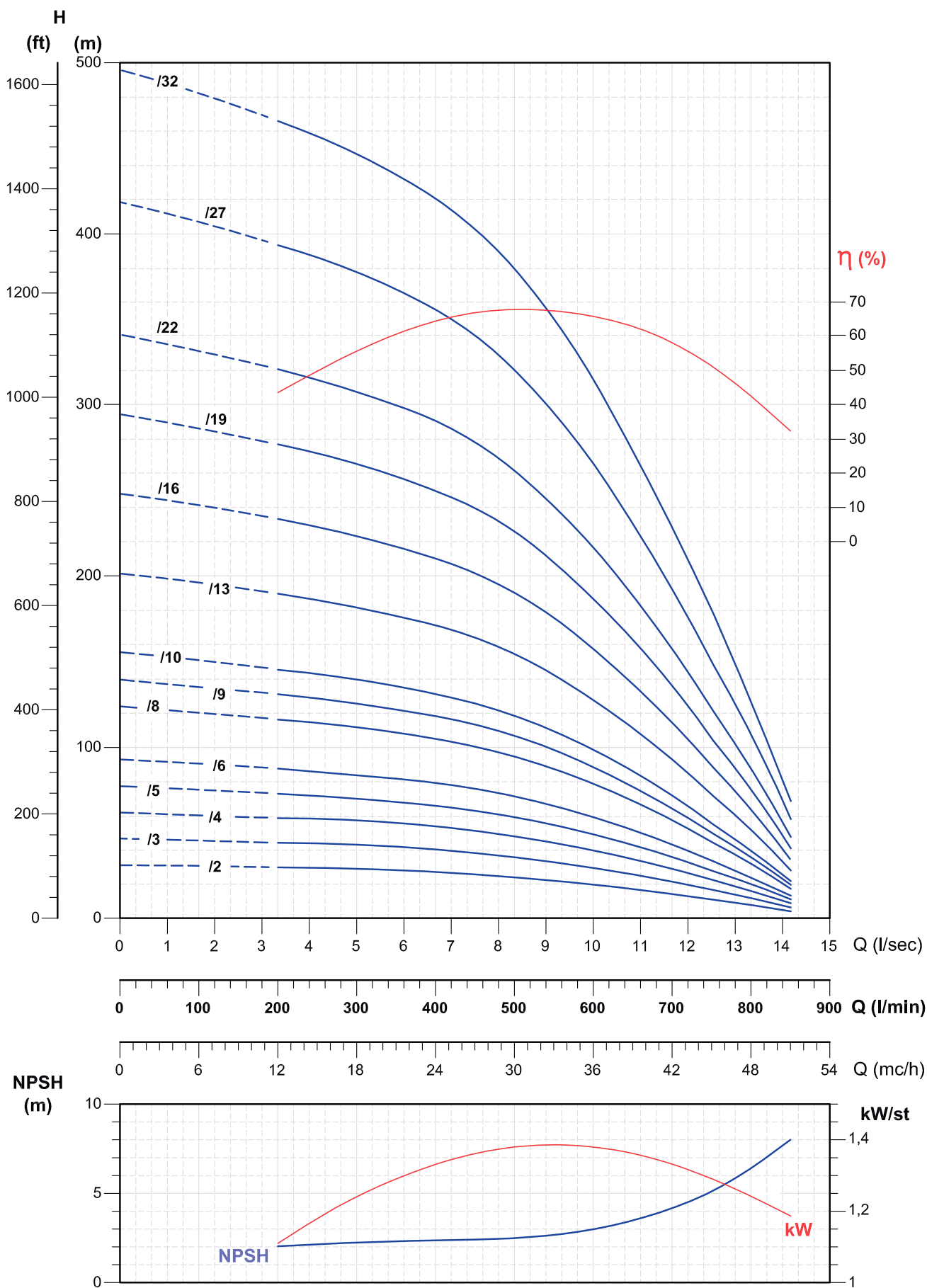

Tolleranze secondo EN ISO 9906 app.A Gr.2 - Tolerances according to EN ISO 9906 annex A Gr.2 - Tolérances conformes EN ISO 9906 ann.A Gr.2

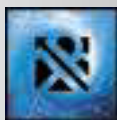

Tipo Type Type	Motore Motors 2900 g/m Moteurs		Q = Portata - Capacity - Débit									
	Cv Hp	Kw	l/sec	0	5,8	7,5	9,2	10,8	12,5	14,2	15,8	17,5
			l/min	0	350	450	550	650	750	850	950	1050
			mc/h	0	21	27	33	39	45	51	57	63
FB6RL/2 + 6F5	5,5	4	H(m)	26	24	23	19	17	14	12	9	5
FB6RL/3+ 6F7	7,5	5,5		39	36	34	29	25	21	18	14	7
FB6RL/4 + 6F10	10	7,5		52	48	45	39	33	28	24	18	9
FB6RL/6 + 6F12	12,5	9,2		77	71	68	58	50	43	36	27	14
FB6RL/7 + 6F15	15	11		90	83	79	68	58	50	42	32	16
FB6RL/8 + 6F17	17,5	13		103	95	90	78	65	57	48	36	18
FB6RL/9 + 6F20	20	15		116	107	101	88	75	64	54	41	21
FB6RL/12 + 6F25	25	18,5		155	143	135	117	99	85	72	54	28
FB6RL/14 + 6F30	30	22		181	167	158	136	116	100	84	63	32
FB6RL/17 + 6F35	35	26		219	202	191	165	141	121	102	77	39
FB6RL/19 + 6F40	40	30		245	226	214	185	157	135	114	86	44
FB6RL/24D + 6F50*	50	37		310	286	270	234	199	171	144	108	55
FB6RL/28D + 6F60*	60	45		361	303	315	272	232	199	168	126	64



Dimensioni e pesi

Overall dimensions and weights - Dimensions d'encombrement et poids

Tipo Type Type	Cv Hp	Kw	A (mm)	B (mm)	C (mm)	D (mm)	ø max (mm)	DN	Peso - Weight - Poids		
									A (kg)	B (kg)	C (kg)
									FB6RL/2 + 6F5	5,5	4
FB6RL/3+ 6F7	7,5	5,5	1095	468	627	56	10	46			
FB6RL/4 + 6F10	10	7,5	1195	528	667	60	10	50			
FB6RL/6 + 6F12	12,5	9,2	1345	648	697	66	12	54			
FB6RL/7 + 6F15	15	11	1475	708	767	74	13	61			
FB6RL/8 + 6F17	17,5	13	1535	768	767	76	14	62			
FB6RL/9 + 6F20	20	15	1655	828	827	83	15	68			
FB6RL/12 + 6F25	25	18,5	1905	1008	897	91	16	75			
FB6RL/14 + 6F30	30	22	2095	1128	967	100	18	82			
FB6RL/17 + 6F35	35	26	2335	1308	1027	111	22	89			
FB6RL/19 + 6F40	40	30	2647	1480	1167	130	27	103			
FB6RL/24D + 6F50*	50	37	3076	1779	1297	153	37	116			
FB6RL/28D + 6F60*	60	45	3286	1959	1327	163	42	121			

* Non consigliata per montaggio in posizione orizzontale

* This electropump isn't recommended for horizontal assemblage

* Cette électropompe n'est pas recommandée pour le montage en position horizontale

CURVE DELLE PRESTAZIONI

PERFORMANCES' CURVES
COURBES DES PERFORMANCES

FB6RL

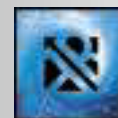

n=2900 1/min 50 Hz

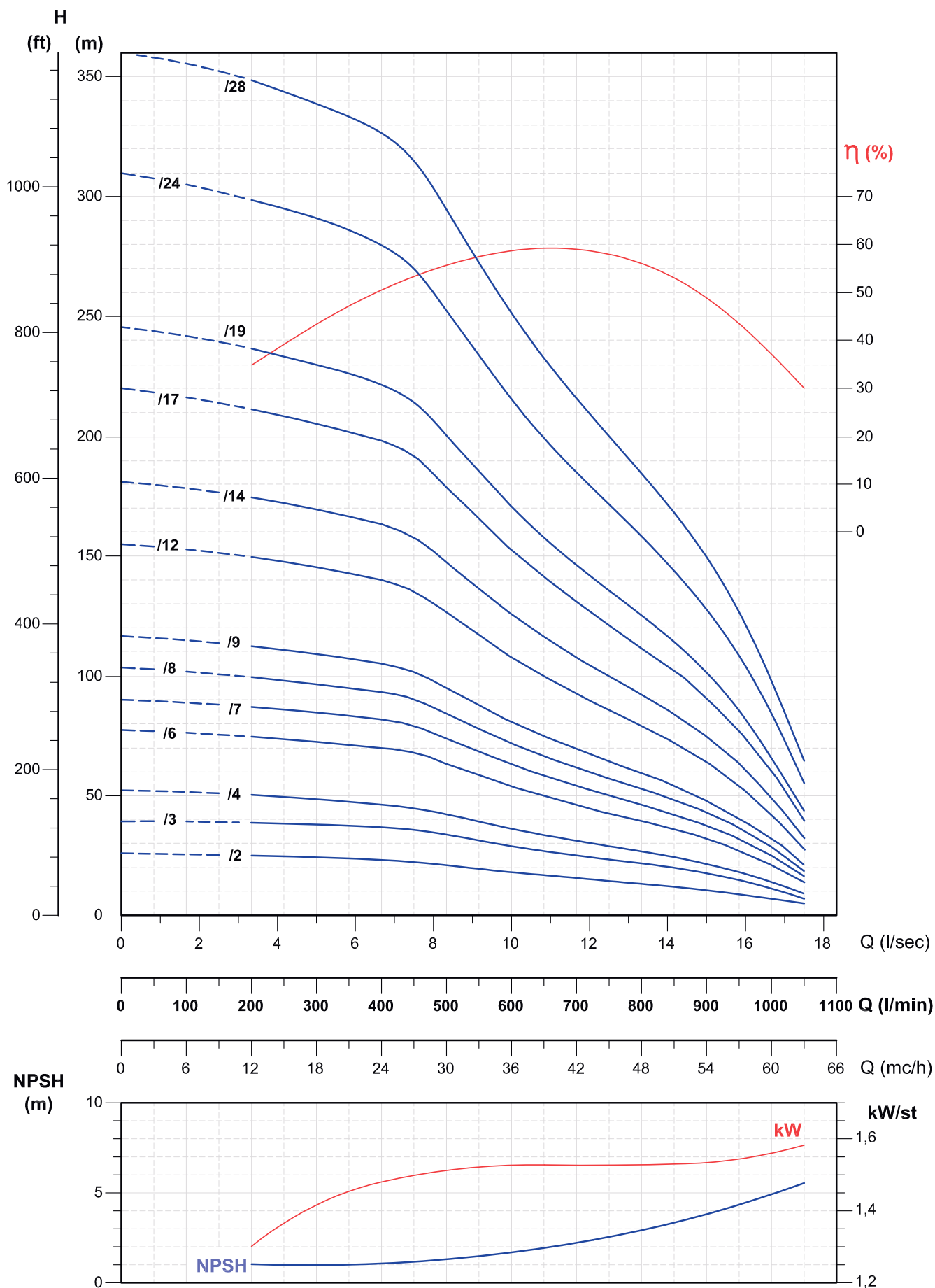

Tolleranze secondo EN ISO 9906 app.A Gr.2 - Tolerances according to EN ISO 9906 annex A Gr.2 - Tolérances conformes EN ISO 9906 ann.A Gr.2

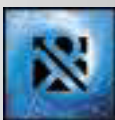

ELETTROPOMPE SOMMERSE RADIALI 6"

6" RADIAL-FLOW SUBMERSIBLE ELECTROPUMPS

ÉLECTROPOMPES IMMERGÉES RADIALES 6"



I corpi pompa 6" di tipo radiale in ghisa, serie FB6R14, sono per acque pulite per pozzi 6" DN 150.

La particolarità delle pompe di tipo radiale è la costruzione a stadi di limitato ingombro assiale, tale particolarità consente di ottenere prevalenze elevate con portate medio – basse.

La robustezza di questa serie è data anche dalla costruzione delle giranti in acciaio inox AISI 304, che consente l'installazione della pompa in pozzi profondi garantendo massima sicurezza all'impianto e generando elevati rendimenti.

APPLICAZIONI:

- irrigazione
- approvvigionamento idrico
- aumento pressione
- antincendio

COSTRUZIONE:

- giranti in acciaio inox AISI 304
- diffusori in acciaio inox AISI 304
- corpo di stadio in ghisa G25
- bocca di mandata in ghisa G25
- valvola di ritegno in ghisa G25
- albero in acciaio inox AISI 420
- proteggi cavo in acciaio inox AISI 304
- griglia d'aspirazione in acciaio inox AISI 304
- viteria in acciaio inox AISI 304

CARATTERISTICHE:

- portata massima: 450 l/m
- prevalenza massima: 703 metri
- potenza massima: 45 Kw
- diametro d'ingombro massimo: 152 mm (incluso il copri cavo)
- temperatura massima dell'acqua: 60°C (solo per corpo pompa, per il motore vedi catalogo motori)
- contenuto di sabbia massimo: 30 g/m³



The cast iron radial - flow 6" pumps, range FB6R14, are for clean water for 6" wells DN 150. The peculiarity of the radial - flow pumps is the stages construction with limited axial dimension, that peculiarity allows to reach high head with small and medium capacity.

The sturdiness of this range is given by the AISI 304 stainless steel impellers, they permit the installation of the pump in deep wells granting maximum safety to the system and producing high performances.

APPLICATIONS:

- irrigation
- water supply system
- pressure boosting
- fire fighting systems

CONSTRUCTION:

- stainless steel AISI 304 impellers
- stainless steel AISI 304 diffusers
- cast iron G25 pump body
- cast iron G25 delivery bowl
- cast iron G25 non-return valve
- stainless steel AISI 420 shaft
- stainless steel AISI 304 cable cover
- stainless steel AISI 304 suction strainer
- stainless steel AISI 304 nuts, bolts and screws

CHARACTERISTICS:

- maximum capacity: 450 l/m
- maximum head: 703 m
- maximum power: 45 Kw
- maximum encumbrance diameter: 152 mm (cable cover included)
- maximum water temperature: 60°C (only for the pump, for the motor see motors' catalogue)
- maximum sand content: 30 g/m³



Les pompes immergées 6" de type radiale en fonte, série FB6R14, sont pour eaux propres pour puits de 6" DN 150.

La particularité des pompes de type radiale est la construction par des stades d'encombrement axial limité, il permet d'obtenir des hauteurs élevées avec des bas et moyens débits.

La solidité de cette gamme de pompes est donnée par la construction des roues en acier inoxydable AISI 304, qui permet l'installation de la pompe dans puits profonds en garantissant sûreté maximale de l'installation et en engendrant hautes performances.

APPLICATIONS:

- irrigation
- installation d'approvisionnement hydrique
- surpression
- anti incendie

CONSTRUCTION:

- roues en acier inoxydable AISI 304
- diffuseur en acier inoxydable AISI 304
- corps d'étage en fonte G25
- orifice de refoulement en fonte G25
- clapet de non retour en fonte G25
- arbre en acier inoxydable AISI 420
- couvre-câble en acier inoxydable AISI 304
- crépine d'aspiration en acier inoxydable AISI 304
- visserie en acier inoxydable AISI 304

CARACTERISTIQUES:

- débit maximum: 450 l/m
- hauteur maximale: 703 mètres
- puissance maximale: 45 Kw
- diamètre d'encombrement maximum: 152 mm (inclus le protection du câble)
- température maximale de l'eau: 60°C (pour la pompe, pour le moteur voir le catalogue des moteurs)
- quantité maximale de sable: 30 g/m³



SPACCATO 6"

6" CUTAWAY
COUPE 6"

FB6R14

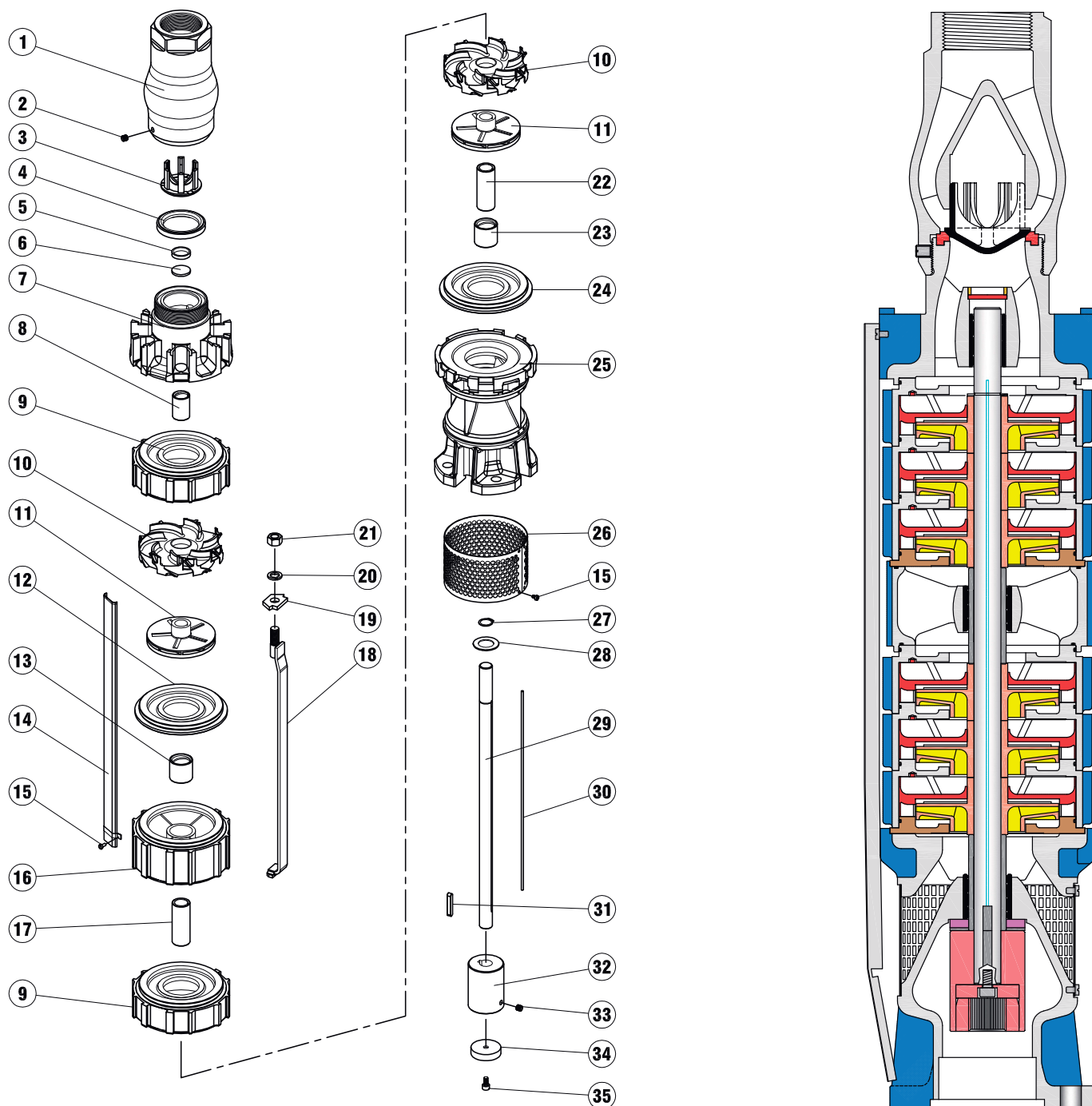
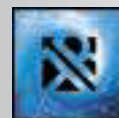

Pos.	Qt.	Denominazione	Denomination	Denomination
1	1	Corpo della valvola	Valve body	Corps de clapet
2	1	Vite	Screw	Vis
3	1	Otturatore della valvola	Wing valve	Soupape du clapet
4	1	Sede valvola	Valve seat	Slège de soupape
5	1	Anello di fermo	Circlip	Segment d'arrêt
6	1	Filtro di sfiato	Vent filter	Filtre de purge d'air
7	1	Camera premente	Discharge casing	Corps de refoulement
8	1	Cuscinetto a boccia	Bearing bush	Coussinet
9	*N	Corpo a mantello	Stage casing	Corps d'étage
10	*N	Diffusore palettato	Diffuser	Diffuseur
11	*N	Girante	Impeller	Roue
12	1	Anello di centraggio	Centring ring	Bague de centrage
13	1-2	Cuscinetto a boccia	Bearing bush	Coussinet intermédiaire
14	1	Tegolo protezione cavo	Cable guard	Protège-cable
15	6-10	Vite	Screw	Vis
16	1-2	Supporto intermedio	Intermediate bearing	Palier intermédiaire
17	1-2	Camicia d'albero	Bearing	Chemise arbre intemed.
18	6	Tirante del corpo	Tie bolt	Tirant d'assemblage

Pos.	Qt.	Denominazione	Denomination	Denomination
19	6	Piastrina per tirante	Pressure plate	Rondelle spéciale
20	6	Rosetta	Washer	Rondelle
21	6	Dado	Nut	Ecrou
22	1	Bussola distanziale	Bearing	Chemise d'arbre
23	1	Cuscinetto a boccia	Bearing bush	Coussinet, côté refoul.
24	1-2	Anello di centraggio	Centring ring	Bague de centrage
25	1	Camera aspirante	Suction casing	Corps d'aspiration
26	1	Griglia d'aspirazione	Suction strainer	Crépine d'aspiration
27	1	Anello di fermo	Circlip for shaft	Segment d'arrêt
28	1-2	Rondella di compens.	Compensating washer	Rondelle de compens.
29	1	Albero pompa	Pump shaft	Arbre de pompe
30	1	Linguetta girante	Key for impeller	Clavette de la roue
31	1	Linguetta giunto	Key for coupling	Clavette pour accoupl.
32	1	Giunto	Coupling	Accouplement
33	1	Vite per giunto	Screw for coupling	Vis pour accouplement
34	1	Rosetta	Washer	Rondelle
35	1	Vite	Screw	Vis

*N=Numero di scatole e giranti variabili dal tipo di pompa

*N=The number of the boxer and the impellers vary according to the type of the pump.

*N=Numéro d'enveloppes et roues selon le type de pompe.



TABELLA DELLE CARATTERISTICHE IDRAULICHE 6"

6" HYDRAULIC FEATURES' CHART

TABLE DES CARACTÉRISTIQUES HYDRAULIQUES 6"

Tipo Type Type	Motore Motor Moteur		Q = Portata - Capacity - Débit																			
			l/sec	0	2	2,2	2,5	2,8	3,1	3,3	3,6	3,9	4,2	4,5	5	5,8	6,7	7,5				
	l/min	0	117	133	150	167	183	200	217	233	250	267	300	350	400	450						
	Hp	Kw	mc/h	0	7	8	9	10	11	12	13	14	15	16	18	21	24	27				
FB6R14A/6	5,5	4		71	72	68	65	60	55	48	39	31										
FB6R14A/9	5,5	4		107	108	102	97	90	82	72	59	47										
FB6R14A/10	7,5	5,5		119	120	113	108	100	91	80	66	52										
FB6R14A/12	7,5	5,5		143	144	137	130	120	109	95	79	62										
FB6R14A/17	10	7,5		202	204	194	184	170	155	134	112	88										
FB6R14A/20	12,5	9,2		238	240	228	216	200	182	158	132	104										
FB6R14A/25	15	11	H(m)	298	300	285	270	250	228	198	165	130										
FB6R14A/29	17,5	13		346	348	331	313	290	264	230	191	151										
FB6R14A/34	20	15		405	408	388	367	340	310	269	224	177										
FB6R14A/38	25	18,5		453	456	433	410	380	347	301	251	198										
FB6R14A/42	25	18,5		501	504	479	454	420	383	333	277	218										
FB6R14A/50	30	22		596	600	570	540	500	456	396	330	260										
FB6R14A/54	35	26		644	648	616	583	540	492	428	356	281										
FB6R14A/59	35	26		703	708	673	637	590	538	467	389	307										
FB6R14B/7	5,5	4			87				83	78	74	69	63	57	50	35						
FB6R14B/9	7,5	5,5			111				106	101	95	88	81	74	65	45						
FB6R14B/13	10	7,5			161				153	146	138	127	117	106	93	65						
FB6R14B/16	12,5	9,2			198				189	179	170	157	144	130	114	80						
FB6R14B/19	15	11			235				224	213	201	186	171	155	136	95						
FB6R14B/23	17,5	13		H(m)	284				271	258	244	225	207	187	164	115						
FB6R14B/26	20	15	321					307	291	276	255	234	212	186	130							
FB6R14B/33	25	18,5	408					389	370	350	323	297	269	236	165							
FB6R14B/39	30	22	482					460	437	413	382	351	318	279	195							
FB6R14B/46	35	26	569					543	515	488	451	414	375	329	230							
FB6R14B/53	40	30	655					625	594	562	519	477	433	379	270							

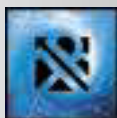
TABELLA DELLE CARATTERISTICHE IDRAULICHE 6"

6" HYDRAULIC FEATURES' CHART

TABLE DES CARACTÉRISTIQUES HYDRAULIQUES 6"

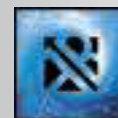

n=2900 1/min 50 Hz

Tipo Type Type	Motore Motor Moteur		Q = Portata - Capacity - Débit																		
			l/sec	0	2	2,2	2,5	2,8	3,1	3,3	3,6	3,9	4,2	4,5	5	5,8	6,7	7,5			
	l/min	0	117	133	150	167	183	200	217	233	250	267	300	350	400	450					
	Hp	Kw	mc/h	0	7	8	9	10	11	12	13	14	15	16	18	21	24	27			
FB6R14C/5	5,5	4		63							62	60	58	56	51	43	33	20			
FB6R14C/7	7,5	5,5		88							86	84	81	78	71	60	46	28			
FB6R14C/9	10	7,5		113							111	108	104	101	92	77	59	36			
FB6R14C/12	12,5	9,2		150							148	144	139	134	122	103	79	48			
FB6R14C/14	15	11		175							172	168	162	157	143	120	92	56			
FB6R14C/16	17,5	13		200							197	192	186	179	163	138	106	64			
FB6R14C/19	20	15	H(m)	238							234	228	220	213	194	163	125	76			
FB6R14C/24	25	18,5		300							295	288	278	269	245	206	158	96			
FB6R14C/28	30	22		350							344	336	325	314	286	241	185	112			
FB6R14C/34	35	26		425							418	408	394	381	347	292	224	136			
FB6R14C/39	40	30		488							480	468	452	437	398	335	257	156			
FB6R14C/44	50	37		550							541	528	510	493	449	378	290	176			
FB6R14C/48	50	37		600							590	576	557	538	490	413	317	192			
FB6R14C/54	60	45		675							664	648	626	605	551	464	356	216			

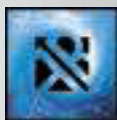

FB6R14A

DATI DELLE PRESTAZIONI
PERFORMANCES' DATA
DONNÉES DES PERFORMANCES

Tipo Type Type	Motore Motors 2900 g/m Moteurs		Q = Portata - Capacity - Débit									
			l/sec	0	2	2,2	2,5	2,8	3,1	3,3	3,6	3,9
			l/min	0	117	133	150	167	183	200	217	233
Cv Hp	Kw	mc/h	0	7	8	9	10	11	12	13	14	
FB6R14A/6 + 6F5	5,5	4	H(m)	71	72	68	65	60	55	48	39	31
FB6R14A/9 + 6F5	5,5	4	107	108	102	97	90	82	72	59	47	
FB6R14A/10 + 6F7	7,5	5,5	119	120	113	108	100	91	80	66	52	
FB6R14A/12 + 6F7	7,5	5,5	143	144	137	130	120	109	95	79	62	
FB6R14A/17 + 6F10	10	7,5	202	204	194	184	170	155	134	112	88	
FB6R14A/20 + 6F12	12,5	9,2	238	240	228	216	200	182	158	132	104	
FB6R14A/25 + 6F15	15	11	298	300	285	270	250	228	198	165	130	
FB6R14A/29 + 6F17	17,5	13	346	348	331	313	290	264	230	191	151	
FB6R14A/34 + 6F20	20	15	405	408	388	367	340	310	269	224	177	
FB6R14A/38 + 6F25	25	18,5	453	456	433	410	380	347	301	251	198	
FB6R14A/42 + 6F25	25	18,5	501	504	479	454	420	383	333	277	218	
FB6R14A/50 + 6F30*	30	22	596	600	570	540	500	456	396	330	260	
FB6R14A/54 + 6F35*	35	26	644	648	616	583	540	492	428	356	281	
FB6R14A/59 + 6F35*	35	26	703	708	673	637	590	538	467	389	307	

Dimensioni e pesi

Overall dimensions and weights - Dimensions d'encombrement et poids

Tipo Type Type	Cv Hp	Kw	A (mm)	B (mm)	C (mm)	D (mm)	ø max (mm)	DN	Peso - Weight - Poids		
									A (kg)	B (kg)	C (kg)
FB6R14A/6 + 6F5	5,5	4	1263	666	597	145	152	G 2"	74	30	44
FB6R14A/9 + 6F5	5,5	4	1377	780	597				81	37	44
FB6R14A/10 + 6F7	7,5	5,5	1445	818	627				85	39	46
FB6R14A/12 + 6F7	7,5	5,5	1585	958	627				94	48	46
FB6R14A/17 + 6F10	10	7,5	1787	1120	667				110	60	50
FB6R14A/20 + 6F12	12,5	9,2	1959	1262	697				120	66	54
FB6R14A/25 + 6F15	15	11	2261	1494	767				141	80	61
FB6R14A/29 + 6F17	17,5	13	2416	1649	767				153	91	62
FB6R14A/34 + 6F20	20	15	2685	1858	827				170	102	68
FB6R14A/38 + 6F25	25	18,5	2907	2010	897				186	111	75
FB6R14A/42 + 6F25	25	18,5	3059	2162	897				194	119	75
FB6R14A/50 + 6F30*	30	22	3433	2466	967				219	137	82
FB6R14A/54 + 6F35*	35	26	3645	2618	1027				235	146	89
FB6R14A/59 + 6F35*	35	26	3845	2818	1027				247	158	89



* Non consigliata per montaggio in posizione orizzontale

* This electropump isn't recommended for horizontal assemblage

* Cette électropompe n'est pas recommandée pour le montage en position horizontale

CURVE DELLE PRESTAZIONI

PERFORMANCES' CURVES

COURBES DES PERFORMANCES

FB6R14A

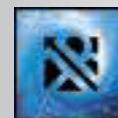

n=2900 1/min 50 Hz

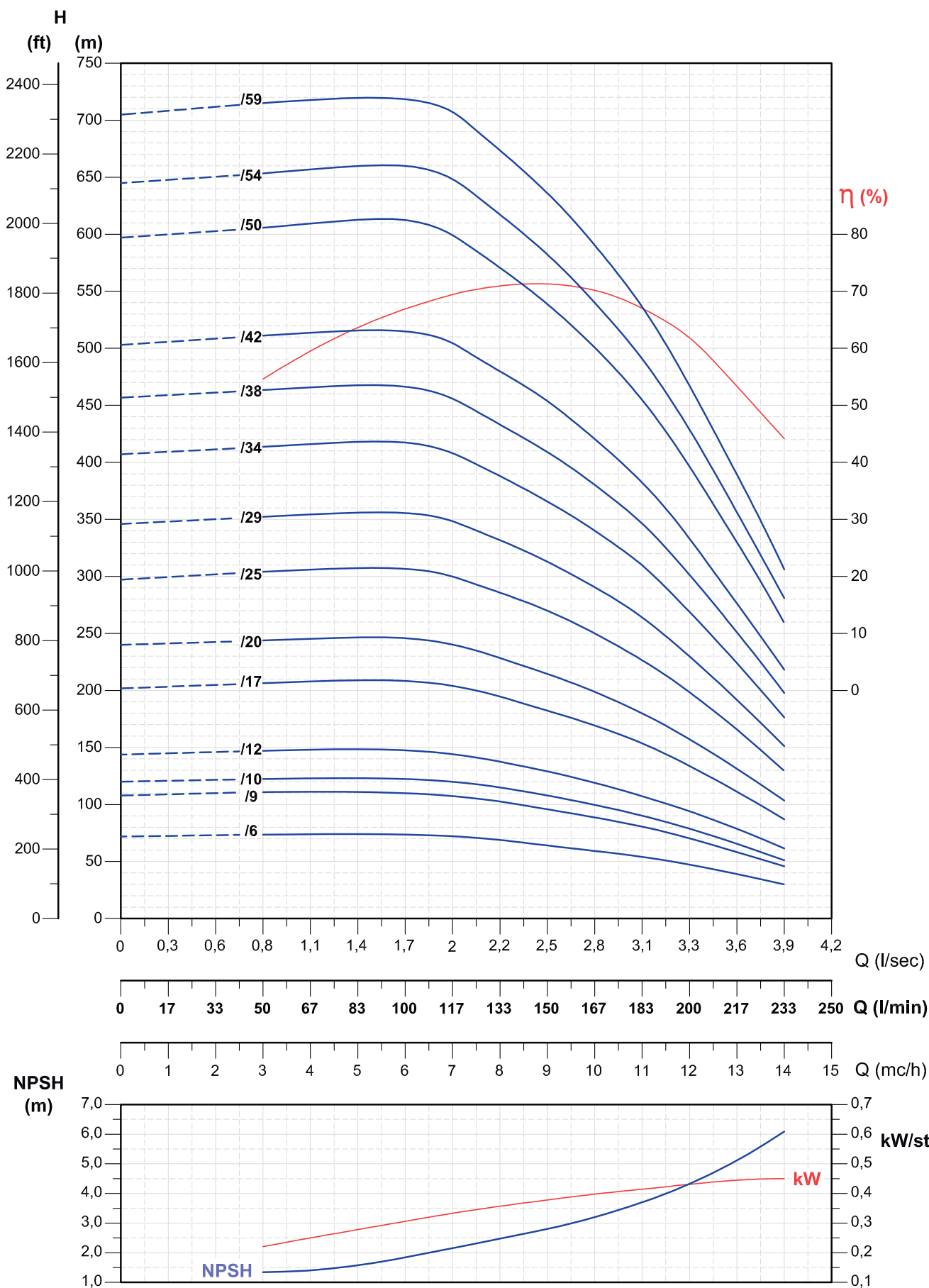

Tolleranze secondo EN ISO 9906 app.A Gr.2 - Tolerances according to EN ISO 9906 anx.A Gr.2 - Tolérances conformes EN ISO 9906 ann.A Gr.2
 Rispetta il Reg. UE n° 547/2012 con MEI = 0.40 - Comply with Reg. UE n° 547/2012 with MEI = 0.40 - Conforme Reg. UE n°547/2012 avec MEI =0.40

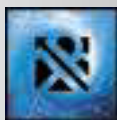

FB6R14B

DATI DELLE PRESTAZIONI
PERFORMANCES' DATA
DONNÉES DES PERFORMANCES

Tipo Type Type	Motore Motors 2900 g/m Moteurs		Q = Portata - Capacity - Débit									
			l/sec	0	2,2	2,5	2,8	3,3	3,9	4,2	4,5	5
	Cv Hp	Kw	l/min	0	133	150	167	200	233	250	267	300
			mc/h	0	8	9	10	12	14	15	16	18
FB6R14B/7 + 6F5	5,5	4	H(m)	87	90	87	83	74	63	57	50	35
FB6R14B/9 + 6F7	7,5	5,5		111	115	111	106	95	81	74	65	45
FB6R14B/13 + 6F10	10	7,5		161	166	161	153	138	117	106	93	65
FB6R14B/16 + 6F12	12,5	9,2		198	205	198	189	170	144	130	114	80
FB6R14B/19 + 6F15	15	11		235	243	236	224	201	171	155	136	95
FB6R14B/23 + 6F17	17,5	13		284	294	284	271	244	207	187	164	115
FB6R14B/26 + 6F20	20	15		321	333	322	307	276	234	212	186	130
FB6R14B/33 + 6F25	25	18,5		408	422	409	389	350	297	269	236	165
FB6R14B/39 + 6F30*	30	22		482	499	484	460	413	351	318	279	195
FB6R14B/46 + 6F35*	35	26		569	589	570	543	488	414	375	329	230
FB6R14B/53 + 6F40*	40	30		655	678	655	625	562	477	433	379	270

Dimensioni e pesi

Overall dimensions and weights - Dimensions d'encombrement et poids

Tipo Type Type	Cv Hp	Kw	A (mm)	B (mm)	C (mm)	D (mm)	ø max (mm)	DN	Peso - Weight - Poids		
									A (kg)	B (kg)	C (kg)
									FB6R14B/7 + 6F5	5,5	4
FB6R14B/9 + 6F7	7,5	5,5	1407	780	627				83	37	46
FB6R14B/13 + 6F10	10	7,5	1627	960	667				101	51	50
FB6R14B/16 + 6F12	12,5	9,2	1807	1110	697				111	57	54
FB6R14B/19 + 6F15	15	11	1966	1199	767				125	64	61
FB6R14B/23 + 6F17	17,5	13	2122	1355	767	145	152	G 2"	135	73	62
FB6R14B/26 + 6F20	20	15	2381	1554	827				152	84	68
FB6R14B/33 + 6F25	25	18,5	2700	1803	897				175	100	75
FB6R14B/39 + 6F30*	30	22	3001	2034	967				195	113	82
FB6R14B/46 + 6F35*	35	26	3341	2314	1027				217	128	89
FB6R14B/53 + 6F40*	40	30	3737	2570	1167				247	144	103



* Non consigliata per montaggio in posizione orizzontale

* This electropump isn't recommended for horizontal assemblage

* Cette électropompe n'est pas recommandée pour le montage en position horizontale

CURVE DELLE PRESTAZIONI

PERFORMANCES' CURVES

COURBES DES PERFORMANCES

FB6R14B

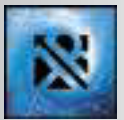

n=2900 1/min 50 Hz

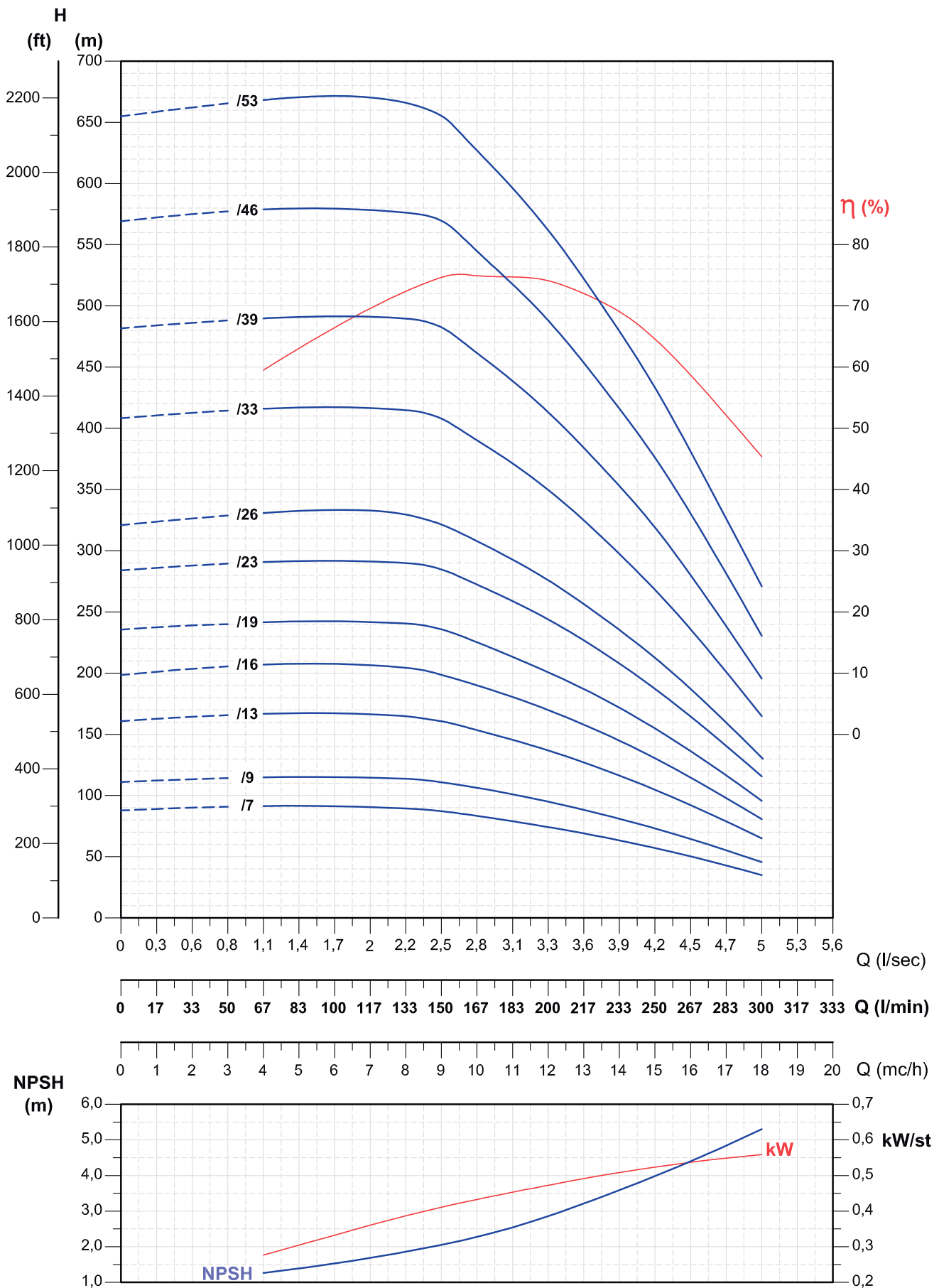

Tolleranze secondo EN ISO 9906 app.A Gr.2 - Tolerances according to EN ISO 9906 anx.A Gr.2 - Tolérances conformes EN ISO 9906 ann.A Gr.2
 Rispetta il Reg. UE n° 547/2012 con MEI = 0.40 - Comply with Reg. UE n° 547/2012 with MEI = 0.40 - Conforme Reg. UE n°547/2012 avec MEI=0.40

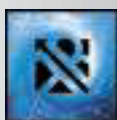

FB6R14C

DATI DELLE PRESTAZIONI
PERFORMANCES' DATA
DONNÉES DES PERFORMANCES

Tipo Type Type	Motore Motors 2900 g/m Moteurs		Q = Portata - Capacity - Débit									
			l/sec	0	3,3	3,6	3,9	4,2	5	5,8	6,7	7,5
	Cv Hp	Kw	l/min	0	200	217	233	250	300	350	400	450
			mc/h	0	12	13	14	15	18	21	24	27
FB6R14C/5 + 6F5	5,5	4	H(m)	63	63	62	60	58	51	43	33	20
FB6R14C/7 + 6F7	7,5	5,5		88	88	86	84	81	71	60	46	28
FB6R14C/9 + 6F10	10	7,5		113	113	111	108	104	92	77	59	36
FB6R14C/12 + 6F12	12,5	9,2		150	151	148	144	139	122	103	79	48
FB6R14C/14 + 6F15	15	11		175	176	172	168	162	143	120	92	56
FB6R14C/16 + 6F17	17,5	13		200	202	197	192	186	163	138	106	64
FB6R14C/19 + 6F20	20	15		238	239	234	228	220	194	163	125	76
FB6R14C/24 + 6F25	25	18,5		300	302	295	288	278	245	206	158	96
FB6R14C/28 + 6F30	30	22		350	353	344	336	325	286	241	185	112
FB6R14C/34 + 6F35	35	26		425	428	418	408	394	347	292	224	136
FB6R14C/39 + 6F40*	40	30		488	491	480	468	452	398	335	257	156
FB6R14C/44 + 6F50*	50	37		550	554	541	528	510	449	378	290	176
FB6R14C/48 + 6F50*	50	37		600	605	590	576	557	490	413	317	192
FB6R14C/54 + 6F60*	60	45		675	680	664	648	626	551	464	356	216

Dimensioni e pesi

Overall dimensions and weights - Dimensions d'encombrement et poids

Tipo Type Type	Cv Hp	Kw	A (mm)	B (mm)	C (mm)	D (mm)	ø max (mm)	DN	Peso - Weight - Poids		
									A (kg)	B (kg)	C (kg)
FB6R14C/5 + 6F5	5,5	4	1225	628	597	145	152	G 2"	72	28	44
FB6R14C/7 + 6F7	7,5	5,5	1331	704	627				78	32	46
FB6R14C/9 + 6F10	10	7,5	1447	780	667				87	37	50
FB6R14C/12 + 6F12	12,5	9,2	1655	958	697				102	48	54
FB6R14C/14 + 6F15	15	11	1801	1034	767				114	53	61
FB6R14C/16 + 6F17	17,5	13	1877	1110	767				119	57	62
FB6R14C/19 + 6F20	20	15	2026	1199	827				132	64	68
FB6R14C/24 + 6F25	25	18,5	2311	1414	897				150	75	75
FB6R14C/28 + 6F30	30	22	2597	1630	967				171	89	82
FB6R14C/34 + 6F35	35	26	2885	1858	1027				191	102	89
FB6R14C/39 + 6F40*	40	30	3201	2034	1167				216	113	103
FB6R14C/44 + 6F50*	50	37	3535	2238	1297				240	124	116
FB6R14C/48 + 6F50*	50	37	3687	2390	1297				249	133	116
FB6R14C/54 + 6F60*	60	45	3945	2618	1327				267	146	121



* Non consigliata per montaggio in posizione orizzontale

* This electropump isn't recommended for horizontal assemblage

* Cette électropompe n'est pas recommandée pour le montage en position horizontale

Tolleranze secondo EN ISO 9906 app.A Gr.2 - Tolerances according to EN ISO 9906 anx.A Gr.2 - Tolérances conformes EN ISO 9906 ann.A Gr.2
Rispetta il Reg. UE n° 547/2012 con MEI = 0.40 - Comply with Reg. UE n° 547/2012 with MEI = 0.40 - Conforme Reg. UE n°547/2012 avec MEI = 0.40

CURVE DELLE PRESTAZIONI

PERFORMANCES' CURVES

COURBES DES PERFORMANCES

FB6R14C

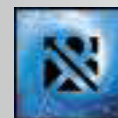

n=2900 1/min 50 Hz

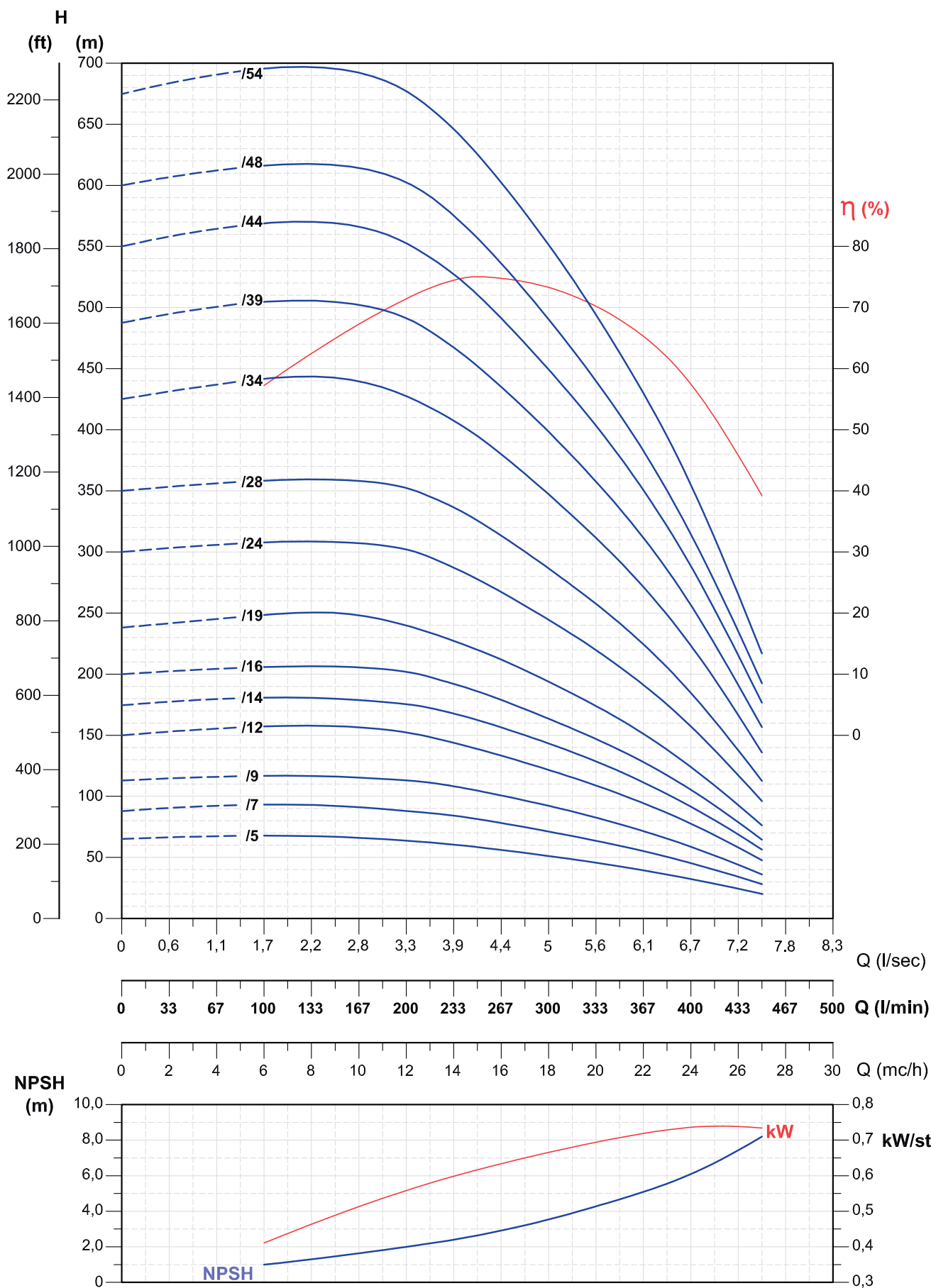

Tolleranze secondo EN ISO 9906 app.A Gr.2 - Tolerances according to EN ISO 9906 anx.A Gr.2 - Tolérances conformes EN ISO 9906 ann.A Gr.2
 Rispetta il Reg. UE n° 547/2012 con MEI = 0.40 - Comply with Reg. UE n° 547/2012 with MEI = 0.40 - Conforme Reg. UE n°547/2012 avec MEI = 0.40

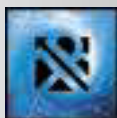

ELETTROPOMPE SOMMERSE 6" SEMIASSIALI IN GHISA

6" CAST IRON MIXED-FLOW SUBMERSIBLE ELECTROPUMPS

ÉLECTROPOMPES IMMERGÉES 6" SEMI-AXIALES EN FONTE



I corpi pompa 6" di tipo semiassiale, serie FB6S, sono per acque pulite per pozzi 6" DN 150.

Questo tipo di pompa è costituito dalla presenza dei corpi di stadio con diffusore incorporato e dalle giranti semiassiali, è da preferire quando si ha necessità di avere elevate portate con prevalenze medio-basse.

APPLICAZIONI:

- irrigazione
- approvvigionamento idrico
- aumento pressione
- antincendio

COSTRUZIONE:

- girante in ghisa G25
- corpo di stadio in ghisa G25
- bocca di mandata in ghisa G25
- valvola di ritegno in ghisa G25
- albero in acciaio inox AISI 420
- copri cavo in acciaio inox AISI 304
- griglia d'aspirazione in acciaio inox AISI 304
- viteria in acciaio inox AISI 304

CARATTERISTICHE:

- portata massima: 1417 l/m
- prevalenza massima: 401 metri
- potenza massima: 45 Kw
- diametro d'ingombro massimo: 150 mm (incluso il copri cavo)
- temperatura massima dell'acqua: 60°C (solo per corpo pompa, per il motore vedi catalogo motori)
- contenuto di sabbia massimo: 100 g/m³

OPTIONAL:

Su richiesta si possono fornire corpi pompa in ghisa:

- con giranti in bronzo GCuSn10 (B10)
- con giranti in acciaio inox AISI 316



6" pumps mixed-flow type, range FB6S, are for clean water for 6" wells DN 150.

This pumps have mixed-flow impellers with diffusers combined on each stage. They may be chosen when high capacity and medium-low head are needed.

APPLICATIONS:

- irrigation
- water supply system
- pressure boosting
- fire-fighting systems

CONSTRUCTION:

- cast iron G25 impellers
- cast iron G25 delivery bowl
- cast iron G25 pump body
- cast iron G25 non-return valve
- stainless steel AISI 420 shaft
- stainless steel AISI 304 cable cover
- stainless steel AISI 304 suction strainer
- stainless steel AISI 304 nuts, bolts and screws

FEATURES:

- maximum capacity: 1417 l/m
- maximum head: 401 meters
- maximum power: 45 Kw

- maximum encumbrance diameter: 150 mm (cable cover included)
- maximum water temperature: 60°C (only for the pump, for the motor see motors' catalogue)
- maximum sand content: 100 g/m³

OPTIONAL:

On demand cast iron pumps can be manufactured with:

- bronze GCuSn10 (B10) impellers
- stainless steel AISI 316 impellers



Les pompes 6" semi-axiales en fonte, série FB6S, sont pour eaux propres pour puits de 6" DN150. Ces pompes sont caractérisées par la présence de stades avec le diffuseur incorporé et roues semi-axiales. La gamme semi-axiale est à préférer quand il faut avoir hautes débits avec des basses et moyennes hauteurs.

APPLICATIONS:

- irrigation
- installation d'approvisionnement hydrique
- surpression
- anti incendie

CONSTRUCTION:

- roues en fonte G25
- corps d'étage en fonte G25
- orifice de refoulement en fonte G25
- crépine de non-retour en fonte G25
- arbre en acier inoxydable AISI 420
- couvre-câble en acier inoxydable AISI 304
- crépine d'aspiration en acier inoxydable AISI 304
- visserie en acier inoxydable AISI 304

CARACTÉRISTIQUES:

- débit maximum: 1417 l/m
- hauteur maximale: 401 mètres
- puissance maximale: 45 Kw
- diamètre d'encombrement maximum: 150 mm (inclus le couvre-câble)
- température maximale de l'eau: 60°C (pour la pompe, pour le moteur voir le catalogue des moteurs)
- quantité maximale de sable: 100 g/m³

OPTIONAL:

Sur demande on peut fournir pompes en fonte:

- avec roues en bronze GCuSn10 (B10)
- avec roues en acier inoxydable AISI 316



ELETTROPOMPE SOMMERSE 6" SEMIASSIALI IN BRONZO

6" BRONZE MIXED-FLOW SUBMERSIBLE ELECTROPUMPS

ÉLECTROPOMPES IMMERGÉES 6" SEMI-AXIALES EN BRONZE

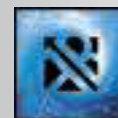

APPLICAZIONI:

- irrigazione, approvvigionamento idrico, aumento pressione ed antincendio
- acqua di mare
- acque salmastre

COSTRUZIONE:

- girante in bronzo GCuSn10 (B10)
- corpo di stadio in bronzo GCuSn10 (B10)
- bocca di mandata in bronzo GCuSn10 (B10)
- valvola di ritegno in bronzo GCuSn10 (B10)
- albero in acciaio inox AISI 316
- copri cavo in acciaio inox AISI 316
- griglia d'aspirazione in acciaio inox AISI 316
- viteria in acciaio inox AISI 316

CARATTERISTICHE:

- portata massima: 1417 l/m
- prevalenza massima: 401 metri
- potenza massima: 45 Kw
- diametro d'ingombro massimo: 150 mm (incluso il copri cavo)
- temperatura massima dell'acqua: 60°C (solo per corpo pompa, per il motore vedi catalogo motori)
- contenuto di sabbia massimo: 100 g/m³



APPLICATIONS:

- irrigation, water supply system, pressure boosting and fire-fighting systems
- sea water
- brackish water

CONSTRUCTION:

- bronze GCuSn10 (B10) impellers
- bronze GCuSn10 (B10) delivery bowl
- bronze GCuSn10 (B10) pump body
- bronze GCuSn10 (B10) non-return valve
- stainless steel AISI 316 shaft
- stainless steel AISI 316 cable cover
- stainless steel AISI 316 suction strainer
- stainless steel AISI 316 nuts, bolts and screws

FEATURES:

- maximum capacity: 1417 l/m
- maximum head: 401 meters
- maximum power: 45 Kw
- maximum encumbrance diameter: 150 mm (cable cover included)
- maximum water temperature: 60°C (only for the pump, for the motor see motors' catalogue)
- maximum sand content: 100 g/m³



APPLICATIONS:

- irrigation, installation d'approvisionnement hydrique, surpression et anti incendie
- eau de mer
- eau saumâtre

CONSTRUCTION:

- roues en bronze GCuSn10 (B10)
- corps d'étage en bronze GCuSn10 (B10)
- orifice de refoulement bronze GCuSn10 (B10)
- crépine de non-retour en bronze GCuSn10 (B10)
- arbre en acier inoxydable AISI 316
- couvre-câble en acier inoxydable AISI 316
- crépine d'aspiration en acier inoxydable AISI 316
- visserie en acier inoxydable AISI 316

CARACTÉRISTIQUES:

- débit maximum: 1417 l/m
- hauteur maximale: 401 mètres
- puissance maximale: 45 Kw
- diamètre d'encombrement maximum: 150 mm (inclus le couvre-câble)
- température maximale de l'eau: 60°C (pour la pompe, pour le moteur voir le catalogue des moteurs)
- quantité maximale de sable: 100 g/m³



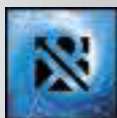

ELETTROPOMPE SOMMERSE 6" SEMIASSIALI IN AISI 316 E DUPLEX

6" STAINLESS STEEL AISI 316 AND DUPLEX MIXED-FLOW SUBMERSIBLE ELECTROPUMPS

ÉLECTROPOMPES IMMERGÉES 6" SEMI-AXIALES EN ACIER INOXYDABLE AISI 316 ET DUPLEX



APPLICAZIONI:

- irrigazione, approvvigionamento idrico, aumento pressione ed antincendio
- acqua potabile
- acque di mare
- acque salmastre
- acque termali e sulfuree
- desalinizzazione ed osmosi
- acque aggressive e corrosive
- vari settori dell'industria: alimentare, petrolchimica, siderurgica e navale
- applicazioni gravose: miniera

CONSTRUZIONE IN ACCIAIO INOX AISI 316:

PREN 26 (Pitting Resistance Equivalent)

- girante in acciaio inox AISI 316 (W. Nr. 1.4401)
- corpo di stadio in acciaio inox AISI 316 (W. Nr. 1.4401)
- bocca di mandata in acciaio inox AISI 316 (W. Nr. 1.4401)
- valvola di ritegno in acciaio inox AISI 316 (W. Nr. 1.4401)
- albero in acciaio inox AISI 316 (W. Nr. 1.4401)
- copri cavo in acciaio inox AISI 316 (W. Nr. 1.4401)
- griglia d'aspirazione in acciaio inox AISI 316 (W. Nr. 1.4401)
- viteria in acciaio inox AISI 316 (W. Nr. 1.4401)

CONSTRUZIONE IN ACCIAIO INOX DUPLEX:

PREN 31 (Pitting Resistance Equivalent)

- girante in acciaio inox duplex (W. Nr. 1.4462)
- corpo di stadio in acciaio inox duplex (W. Nr. 1.4462)
- bocca di mandata in acciaio inox duplex (W. Nr. 1.4462)
- valvola di ritegno in acciaio inox duplex (W. Nr. 1.4462)
- albero in acciaio inox duplex (W. Nr. 1.4462)
- copri cavo in acciaio inox duplex (W. Nr. 1.4462)
- griglia d'aspirazione in acciaio inox duplex (W. Nr. 1.4462)
- viteria in acciaio inox duplex (W. Nr. 1.4462)

CARATTERISTICHE:

- portata massima: 1417 l/m
- prevalenza massima: 401 metri
- potenza massima: 45 Kw
- diametro d'ingombro massimo: 150 mm (incluso il copri cavo)
- temperatura massima dell'acqua: 60°C (solo per corpo pompa, per il motore vedi catalogo motori)
- contenuto di sabbia massimo: 100 g/m³



APPLICATIONS:

- irrigation, water supply system, pressure boosting, fire-fighting systems
- drinking water
- sea water
- brackish water
- thermal and sulphurous water
- desalinization and osmosis
- aggressive and corrosive waters
- different sectors of the industry: such as food, petrochemical, steel and ship building
- hard applications: mine

STAINLESS STEEL AISI 316 CONSTRUCTION:

PREN 26 (Pitting Resistance Equivalent)

- stainless steel AISI 316 (W. Nr. 1.4401) impellers
- stainless steel AISI 316 (W. Nr. 1.4401) delivery bowl
- stainless steel AISI 316 (W. Nr. 1.4401) pump body
- stainless steel AISI 316 (W. Nr. 1.4401) non-return valve
- stainless steel AISI 316 (W. Nr. 1.4401) shaft
- stainless steel AISI 316 (W. Nr. 1.4401) cable cover
- stainless steel AISI 316 (W. Nr. 1.4401) suction strainer
- stainless steel AISI 316 (W. Nr. 1.4401) nuts, bolts and screws

STAINLESS STEEL DUPLEX CONSTRUCTION

PREN 31 (Pitting Resistance Equivalent)

- stainless steel duplex (W. Nr. 1.4462) impellers
- stainless steel duplex (W. Nr. 1.4462) delivery bowl
- stainless steel duplex (W. Nr. 1.4462) pump body
- stainless steel duplex (W. Nr. 1.4462) non-return valve
- stainless steel duplex (W. Nr. 1.4462) shaft
- stainless steel duplex (W. Nr. 1.4462) cable cover
- stainless steel duplex (W. Nr. 1.4462) suction strainer
- stainless steel duplex (W. Nr. 1.4462) nuts, bolts and screws

FEATURES:

- maximum capacity: 1417 l/m
- maximum head: 401 meters
- maximum power: 45 Kw
- maximum encumbrance diameter: 150 mm (cable cover included)
- maximum water temperature: 60°C (only for the pump, for the motor see motors' catalogue)
- maximum sand content: 100 g/m³



APPLICATIONS:

- irrigation, installation d'approvisionnement hydrique, surpression et anti incendie
- eau potable
- eau de mer
- eau saumâtre
- eau thermale e sulfureuse
- dessalement et osmose
- eau agressive et corrosives
- différents secteurs de l'industrie: alimentaire, pétrochimie, sidérurgique et navale
- applications dures: mine

CONSTRUCTION EN ACIER INOX AISI 316:

PREN 26 (Pitting Resistance Equivalent)

- roues en acier inoxydable AISI 316 (W. Nr. 1.4401)
- corps d'étage en acier inoxydable AISI 316 (W. Nr. 1.4401)
- orifice de refoulement en acier inoxydable AISI 316 (W. Nr. 1.4401)
- crépine de non-retour en acier inoxydable AISI 316 (W. Nr. 1.4401)
- arbre en acier inoxydable AISI 316 (W. Nr. 1.4401)
- couvre-câble en acier inoxydable AISI 316 (W. Nr. 1.4401)
- crépine d'aspiration en acier inoxydable AISI 316 (W. Nr. 1.4401)
- visserie en acier inoxydable AISI 316 (W. Nr. 1.4401)

CONSTRUCTION EN ACIER INOX DUPLEX:

PREN 31 (Pitting Resistance Equivalent)

- roues en acier inoxydable duplex (W. Nr. 1.4462)
- corps d'étage en acier inoxydable duplex (W. Nr. 1.4462)
- orifice de refoulement en acier inoxydable duplex (W. Nr. 1.4462)
- crépine de non-retour en acier inoxydable duplex (W. Nr. 1.4462)
- arbre en acier inoxydable duplex (W. Nr. 1.4462)
- couvre-câble en acier inoxydable duplex (W. Nr. 1.4462)
- crépine d'aspiration en acier inoxydable duplex (W. Nr. 1.4462)
- visserie en acier inoxydable duplex (W. Nr. 1.4462)

CARACTÉRISTIQUES:

- débit maximum: 1417 l/m
- hauteur maximale: 401 mètres
- puissance maximale: 45 Kw
- diamètre d'encombrement maximum: 150 mm (inclus le couvre-câble)
- température maximale de l'eau: 60°C (pour la pompe, pour le moteur voir le catalogue des moteurs)
- quantité maximale de sable: 100 g/m³



SPACCATO 6"

6" CUTAWAY
COUPE 6"

FB6S

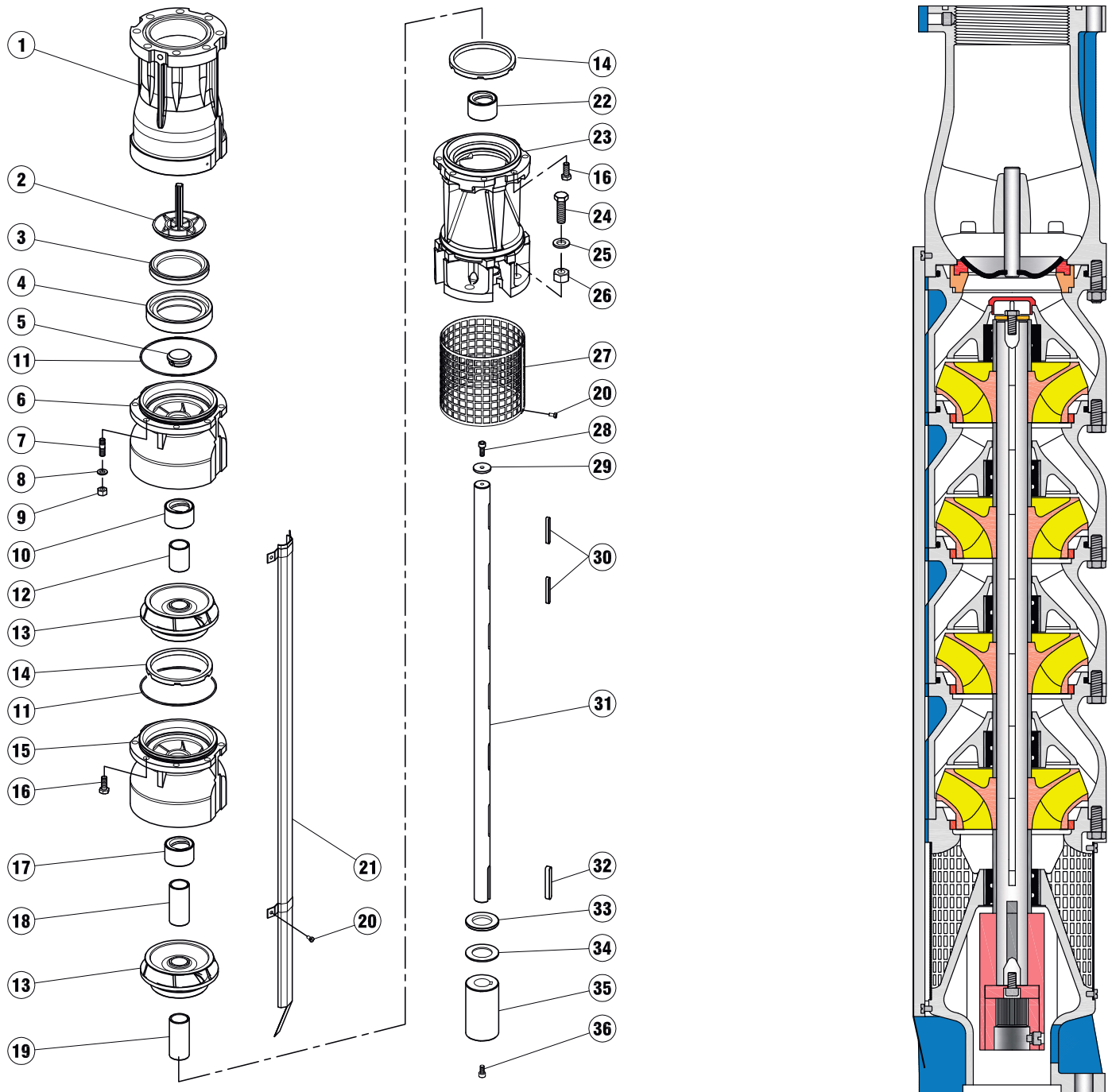
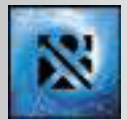

Pos.	Qt.	Denominazione	Denomination	Denomination
1	1	Corpo della valvola	Valve body	Corps de clapet
2	1	Otturatore della valvola	Wing valve	Soupape du clapet
3	1	Sede valvola	Valve seat	Siège de soupape
4	1	Anello di raccordo	Valve insert ring	Bague du clapet
5	1	Corperchio di protez.	Vent plug	Bouchon de purge d'air
6	1	Corpo raddrizzatore	Pump bowl	Corps redresseur
7	*N	Prigioniero	Stud	Goujon
8	8	Rosetta	Washer	Rondelle
9	8	Dado	Nut	Ecrou
10	1	Cuscinetto a boccola	Bearing bush	Coussinet
11	*N-1	Guarnizione corpo	Joint for stage casing	Joint du corps d'étage
12	1	Bussola distanziale	Bearing sleeve	Chemise d'arbre
13	*N	Girante	Impeller	Roue
14	*N	Anello di usura fisso	Casing wear ring	Bague d'usure
15	*N	Corpo raddrizzatore	Pump bowl	Corps redresseur
16	*Nx8	Vite	Screw	Vis
17	*N	Bussola intermedia	Interstage bush	Douille entre étages
18	*N-1	Bussola interstadi	Interstage sleeve	Chemise entretoise

Pos.	Qt.	Denominazione	Denomination	Denomination
19	1	Bussola distanziale	Bearing sleeve	Chemise d'arbre
20	1	Vite	Screw	Vis
21	1-2	Tegolo protezione cavo	Cable guard	Protège-cable
22	1	Cuscinetto a boccola	Bearing bush	Coussinet
23	1	Camera aspirante	Suction casing	Corps d'aspiration
24	4	Vite	Screw	Vis
25	4	Rosetta	Washer	Rondelle
26	4	Dado	Nut	Ecrou
27	1	Griglia d'aspirazione	Suction strainer	Crépine d'aspiration
28	1	Vite	Screw	Vis
29	1	Rosetta ghiera albero	Washer for shaft nut	Rondelle
30	*Nx2	Linguetta girante	Key for impeller	Clavette de la roue
31	1	Albero pompa	Pump shaft	Arbre de pompe
32	1	Linguetta giunto	Key for coupling	Clavette pour accoupl.
33	1	Anello contosp. fisso	Counter ring	Grain fixe de contre
34	1	Anello contosp. mobile	Counter ring	Grain fixe de contre
35	1	Giunto	Coupling	Accouplement
36	1-2	Vite	Screw	Vis

*N=Numero di scatole e giranti variabili dal tipo di pompa

*N=The number of the boxer and the impellers vary according to the type of the pump.

*N=Numéro d'enveloppes et roues selon le type de pompe.



TABELLA DELLE CARATTERISTICHE IDRAULICHE 6"

6" HYDRAULIC FEATURES' CHART

TABLE DES CARACTÉRISTIQUES HYDRAULIQUES 6"

Tipo Type Type	Motore Motor Moteur		Q = Portata - Capacity - Débit																		
			l/sec	0	4,2	5,6	7	8,3	9,7	11,1	12,5	13,9	15,3	16,7	18,1	19,5	20,8				
	l/min	0	250	333	417	500	583	667	750	833	917	1000	1083	1167	1250						
	Hp	Kw	mc/h	0	15	20	25	30	35	40	45	50	55	60	65	70	75				
FB6SE/3	5,5	4		45	39	37	35	33	30	26	21	16	11								
FB6SE/4	7,5	5,5		60	52	49	47	44	39	34	28	22	12								
FB6SE/5	10	7,5		75	65	62	59	55	50	44	36	27	15								
FB6SE/6	12,5	9,2		91	79	76	72	67	60	53	44	33	18								
FB6SE/8	15	11		122	106	101	96	89	80	70	58	44	24								
FB6SE/9	17,5	13		137	119	113	108	100	90	79	65	50	27								
FB6SE/11	20	15	H(m)	167	145	139	132	122	110	97	80	61	33								
FB6SE/13	25	18,5		198	172	164	156	144	130	114	94	72	39								
FB6SE/16	30	22		243	211	202	192	178	160	141	116	88	48								
FB6SE/19	35	26		289	251	239	228	211	190	167	138	105	57								
FB6SE/22	40	30		334	290	277	264	244	220	194	160	121	66								
FB6SE/26	50	37		395	343	328	312	289	260	229	189	143	78								
FB6SG/2	5,5	4		32				24	22	21	19	18	16	13	10	6					
FB6SG/3	7,5	5,5		49				36	34	32	30	27	24	19	15	10					
FB6SG/4	10	7,5		66				49	46	43	40	36	32	26	20	13					
FB6SG/5	12,5	9,2		83				62	58	54	51	46	41	33	25	17					
FB6SG/6	15	11		101				75	70	66	61	56	49	40	31	20					
FB6SG/7	17,5	13		118				88	82	77	71	65	57	47	36	24					
FB6SG/9	20	15	H(m)	151				100	105	99	92	84	74	60	46	31					
FB6SG/11	25	18,5		185				138	129	121	112	102	90	74	56	37					
FB6SG/13	30	22		218				163	152	143	133	121	107	87	66	44					
FB6SG/15	35	26		252				188	176	165	153	139	123	101	77	51					
FB6SG/18	40	30		302				225	211	198	184	167	148	121	92	61					
FB6SG/21	50	37		353				263	246	231	214	195	172	141	107	71					
FB6SG/24	60	45		401				298	281	264	245	221	197	158	125	84					
FB6SH/2	7,5	5,5		30				24	23	22	20	19	17	15	13	10					
FB6SH/3	10	7,5		47				37	36	33	31	29	26	23	19	15					
FB6SH/4	12,5	9,2		63				50	48	45	42	38	35	31	26	21					
FB6SH/5	15	11		79				63	60	57	53	49	44	39	33	26					
FB6SH/6	17,5	13		96				77	73	69	64	59	53	47	40	32					
FB6SH/7	20	15		112				90	85	81	75	69	62	55	46	37					
FB6SH/9	25	18,5	H(m)	144				115	110	104	96	88	80	70	59	48					
FB6SH/11	30	22		176				141	134	127	118	108	98	86	73	58					
FB6SH/12	35	26		192				154	146	138	128	118	107	94	79	64					
FB6SH/14	40	30		224				179	171	161	150	137	125	109	92	74					
FB6SH/17	50	37		272				218	207	196	182	167	151	133	112	90					
FB6SH/20	60	45		320				256	244	230	214	196	178	156	132	106					

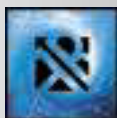
TABELLA DELLE CARATTERISTICHE IDRAULICHE 6"

6" HYDRAULIC FEATURES' CHART

TABLE DES CARACTÉRISTIQUES HYDRAULIQUES 6"

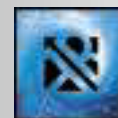

n=2900 1/min 50 Hz

Tipo Type Type	Motore Motor Moteur		Q = Portata - Capacity - Débit																				
			l/sec	0	4,2	5,6	7	8,3	9,7	11,1	12,5	13,9	15,3	16,7	18,1	19,5	20,8	22,2	23,6				
	l/min	0	250	333	417	500	583	667	750	833	917	1000	1083	1167	1250	1333	1417						
	Hp	Kw	mc/h	0	15	20	25	30	35	40	45	50	55	60	65	70	75	80	85				
FB6SL/2	7,5	5,5	H(m)	31							24	23	22	20	19	17	15	12	10				
FB6SL/3	12,5	9,2		48								36	35	33	31	29	26	23	19	15			
FB6SL/4	15	11		64								49	47	45	42	39	35	31	26	20			
FB6SL/5	17,5	13		81								62	59	56	53	49	44	39	32	25			
FB6SL/7	25	18,5		115								88	84	80	74	69	63	55	46	35			
FB6SL/8	30	22		131								100	96	91	85	79	72	63	52	40			
FB6SL/10	35	26		164								125	120	114	106	99	90	79	66	51			
FB6SL/11	40	30		180								138	132	125	117	109	99	87	72	56			
FB6SL/14	50	37		230								175	168	159	149	138	126	110	92	71			
FB6SL/17	60	45		279								212	203	193	181	168	152	134	112	86			

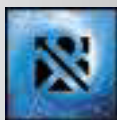

Tipo Type Type	Motore Motors 2900 g/m Moteurs		Q = Portata - Capacity - Débit									
	Cv Hp	Kw	l/sec	0	5,6	7	8,3	9,7	11,1	12,5	13,9	15,3
			l/min	0	333	417	500	583	667	750	833	917
			mc/h	0	20	25	30	35	40	45	50	55
FB6SE/3 + 6F5	5,5	4	H(m)	45	37	35	33	30	26	21	16	11
FB6SE/4 + 6F7	7,5	5,5		60	49	47	44	39	34	28	22	12
FB6SE/5 + 6F10	10	7,5		75	62	59	55	50	44	36	27	15
FB6SE/6 + 6F12	12,5	9,2		91	76	72	67	60	53	44	33	18
FB6SE/8 + 6F15	15	11		122	101	96	89	80	70	58	44	24
FB6SE/9 + 6F17	17,5	13		137	113	108	100	90	79	65	50	27
FB6SE/11 + 6F20	20	15		167	139	132	122	110	97	80	61	33
FB6SE/13 + 6F25	25	18,5		198	164	156	144	130	114	94	72	39
FB6SE/16 + 6F30	30	22		243	202	192	178	160	141	116	88	48
FB6SE/19 + 6F35*	35	26		289	239	228	211	190	167	138	105	57
FB6SE/22 + 6F40*	40	30	334	277	264	244	220	194	160	121	66	
FB6SE/26 + 6F50*	50	37	395	328	312	289	260	229	189	143	78	

Dimensioni e pesi

Overall dimensions and weights - Dimensions d'encombrement et poids

Tipo Type Type	Cv Hp	Kw	A (mm)	B (mm)	C (mm)	D (mm)	ø max (mm)	DN	Peso - Weight - Poids		
									A (kg)	B (kg)	C (kg)
FB6SE/3 + 6F5	5,5	4	1334	737	597	145	150	G 3"	80	36	44
FB6SE/4 + 6F7	7,5	5,5	1469	842	627				88	42	46
FB6SE/5 + 6F10	10	7,5	1614	947	667				98	48	50
FB6SE/6 + 6F12	12,5	9,2	1749	1052	697				108	54	54
FB6SE/8 + 6F15	15	11	2029	1262	767				127	66	61
FB6SE/9 + 6F17	17,5	13	2134	1367	767				134	72	62
FB6SE/11 + 6F20	20	15	2404	1577	827				152	84	68
FB6SE/13 + 6F25	25	18,5	2684	1787	897				171	96	75
FB6SE/16 + 6F30	30	22	3069	2102	967				196	114	82
FB6SE/19 + 6F35*	35	26	3444	2417	1027				221	132	89
FB6SE/22 + 6F40*	40	30	3899	2732	1167	253	150	103			
FB6SE/26 + 6F50*	50	37	4449	3152	1297	290	174	116			



* Non consigliata per montaggio in posizione orizzontale

* This electropump isn't recommended for horizontal assemblage

* Cette électropompe n'est pas recommandée pour le montage en position horizontale

CURVE DELLE PRESTAZIONI

PERFORMANCES' CURVES

COURBES DES PERFORMANCES

FB6SE

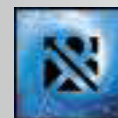

n=2900 1/min 50 Hz

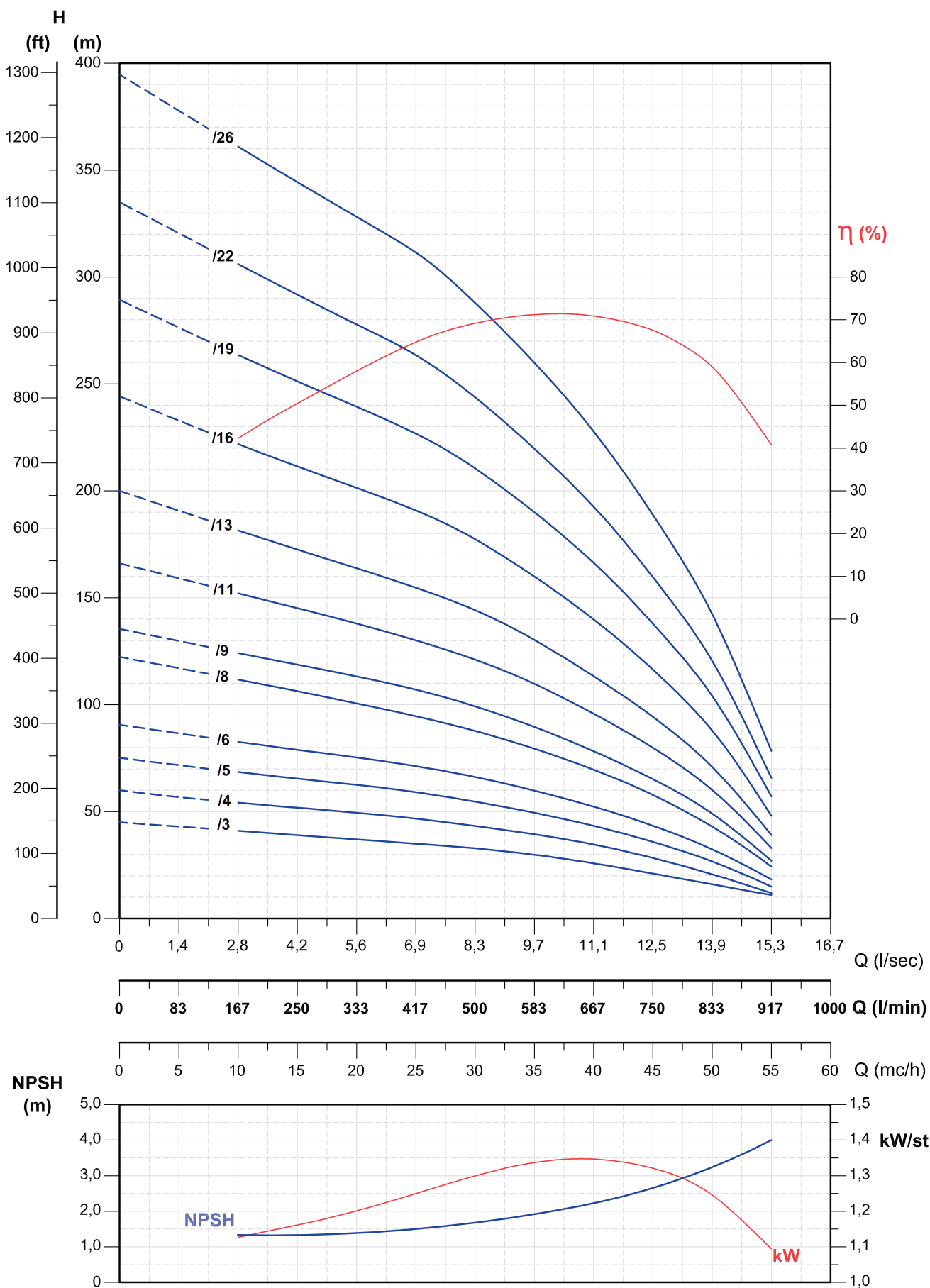

Tolleranze secondo EN ISO 9906 app.A Gr.2 - Tolerances according to EN ISO 9906 anx.A Gr.2 - Tolérances conformes EN ISO 9906 ann.A Gr.2
 Rispetta il Reg. UE n° 547/2012 con MEI = 0.40 - Comply with Reg. UE n° 547/2012 with MEI = 0.40 - Conforme Reg. UE n°547/2012 avec MEI =0.40

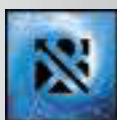

Tipo Type Type	Motore Motors 2900 g/m Moteurs		Q = Portata - Capacity - Débit									
	Cv Hp	Kw	l/sec	0	9,7	11,1	12,5	13,9	15,3	16,7	18,1	19,5
			l/min	0	583	667	750	833	917	1000	1083	1167
			mc/h	0	35	40	45	50	55	60	65	70
FB6SG/2 + 6F5	5,5	4	H(m)	32	22	21	19	18	16	13	10	6
FB6SG/3 + 6F7	7,5	5,5		49	34	32	30	27	24	19	15	10
FB6SG/4 + 6F10	10	7,5		66	46	43	40	36	32	26	20	13
FB6SG/5 + 6F12	12,5	9,2		83	58	54	51	46	41	33	25	17
FB6SG/6 + 6F15	15	11		101	70	66	61	56	49	40	31	20
FB6SG/7 + 6F17	17,5	13		118	82	77	71	65	57	47	36	24
FB6SG/9 + 6F20	20	15		151	105	99	92	84	74	60	46	31
FB6SG/11 + 6F25	25	18,5		185	129	121	112	102	90	74	56	37
FB6SG/13 + 6F30	30	22		218	152	143	133	121	107	87	66	44
FB6SG/15 + 6F35	35	26		252	176	165	153	139	123	101	77	51
FB6SG/18 + 6F40*	40	30		302	211	198	184	167	148	121	92	61
FB6SG/21 + 6F50*	50	37		353	246	231	214	195	172	141	107	71
FB6SG/24 + 6F60*	60	45		401	281	264	245	221	197	158	125	84

Dimensioni e pesi

Overall dimensions and weights - Dimensions d'encombrement et poids

Tipo Type Type	Cv Hp	Kw	A (mm)	B (mm)	C (mm)	D (mm)	ø max (mm)	DN	Peso - Weight - Poids		
									A (kg)	B (kg)	C (kg)
FB6SG/2 + 6F5	5,5	4	1229	632	597	145	150	G 3"	74	30	44
FB6SG/3 + 6F7	7,5	5,5	1364	737	627				82	36	46
FB6SG/4 + 6F10	10	7,5	1509	842	667				92	42	50
FB6SG/5 + 6F12	12,5	9,2	1644	947	697				102	48	54
FB6SG/6 + 6F15	15	11	1819	1052	767				115	54	61
FB6SG/7 + 6F17	17,5	13	1924	1157	767				122	60	62
FB6SG/9 + 6F20	20	15	2194	1367	827				140	72	68
FB6SG/11 + 6F25	25	18,5	2474	1577	897				159	84	75
FB6SG/13 + 6F30	30	22	2754	1787	967				178	96	82
FB6SG/15 + 6F35	35	26	3024	1997	1027				197	108	89
FB6SG/18 + 6F40*	40	30	3479	2312	1167				229	126	103
FB6SG/21 + 6F50*	50	37	3924	2627	1297				260	144	116
FB6SG/24 + 6F60*	60	45	4269	2942	1327				283	162	121



* Non consigliata per montaggio in posizione orizzontale

* This electropump isn't recommended for horizontal assemblage

* Cette électropompe n'est pas recommandée pour le montage en position horizontale

CURVE DELLE PRESTAZIONI

PERFORMANCES' CURVES

COURBES DES PERFORMANCES

FB6SG

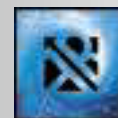

n=2900 1/min 50 Hz

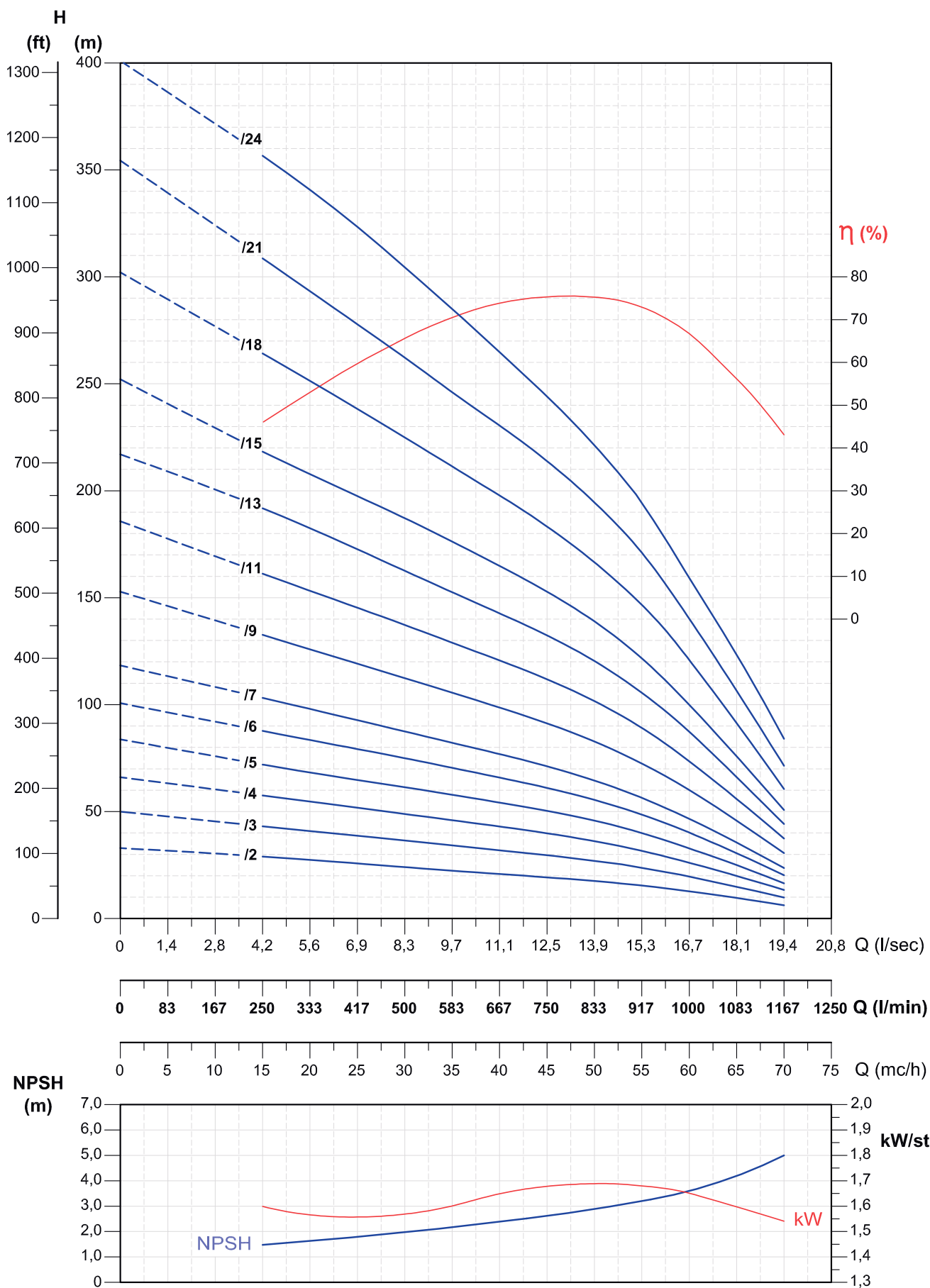

Tolleranze secondo EN ISO 9906 app.A Gr.2 - Tolerances according to EN ISO 9906 anx.A Gr.2 - Tolérances conformes EN ISO 9906 ann.A Gr.2
 Rispetta il Reg. UE n° 547/2012 con MEI = 0.40 - Comply with Reg. UE n° 547/2012 with MEI = 0.40 - Conforme Reg. UE n°547/2012 avec MEI=0.40

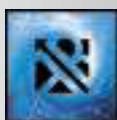

Tipo Type Type	Motore Motors 2900 g/m Moteurs		Q = Portata - Capacity - Débit									
			l/sec	0	11,1	12,5	13,9	15,3	16,7	18,1	19,5	20,8
	Cv Hp	Kw	l/min	0	667	750	833	917	1000	1083	1167	1250
			mc/h	0	40	45	50	55	60	65	70	75
FB6SH/2 + 6F7	7,5	5,5	H(m)	30	23	22	20	19	17	15	13	10
FB6SH/3 + 6F10	10	7,5		47	36	33	31	29	26	23	19	15
FB6SH/4 + 6F12	12,5	9,2		63	48	45	42	38	35	31	26	21
FB6SH/5 + 6F15	15	11		79	60	57	53	49	44	39	33	26
FB6SH/6 + 6F17	17,5	13		96	73	69	64	59	53	47	40	32
FB6SH/7 + 6F20	20	15		112	85	81	75	69	62	55	46	37
FB6SH/9 + 6F25	25	18,5		144	110	104	96	88	80	70	59	48
FB6SH/11 + 6F30	30	22		176	134	127	118	108	98	86	73	58
FB6SH/12 + 6F35	35	26		192	146	138	128	118	107	94	79	64
FB6SH/14 + 6F40*	40	30		224	171	161	150	137	125	109	92	74
FB6SH/17 + 6F50*	50	37	272	207	196	182	167	151	133	112	90	
FB6SH/20 + 6F60*	60	45	320	244	230	214	196	178	156	132	106	

Dimensioni e pesi

Overall dimensions and weights - Dimensions d'encombrement et poids

Tipo Type Type	Cv Hp	Kw	A (mm)	B (mm)	C (mm)	D (mm)	ø max (mm)	DN	Peso - Weight - Poids		
									A (kg)	B (kg)	C (kg)
FB6SH/2 + 6F7	7,5	5,5	1259	632	627	145	150	G 3"	76	30	46
FB6SH/3 + 6F10	10	7,5	1404	737	667				86	36	50
FB6SH/4 + 6F12	12,5	9,2	1539	842	697				96	42	54
FB6SH/5 + 6F15	15	11	1714	947	767				109	48	61
FB6SH/6 + 6F17	17,5	13	1819	1052	767				116	54	62
FB6SH/7 + 6F20	20	15	1984	1157	827				128	60	68
FB6SH/9 + 6F25	25	18,5	2264	1367	897				147	72	75
FB6SH/11 + 6F30	30	22	2544	1577	967				166	84	82
FB6SH/12 + 6F35	35	26	2709	1682	1027				179	90	89
FB6SH/14 + 6F40*	40	30	3059	1892	1167				205	102	103
FB6SH/17 + 6F50*	50	37	3504	2207	1297	236	120	116			
FB6SH/20 + 6F60*	60	45	3849	2522	1327	259	138	121			



* Non consigliata per montaggio in posizione orizzontale

* This electropump isn't recommended for horizontal assemblage

* Cette électropompe n'est pas recommandée pour le montage en position horizontale

CURVE DELLE PRESTAZIONI

PERFORMANCES' CURVES

COURBES DES PERFORMANCES

FB6SH



n=2900 1/min 50 Hz

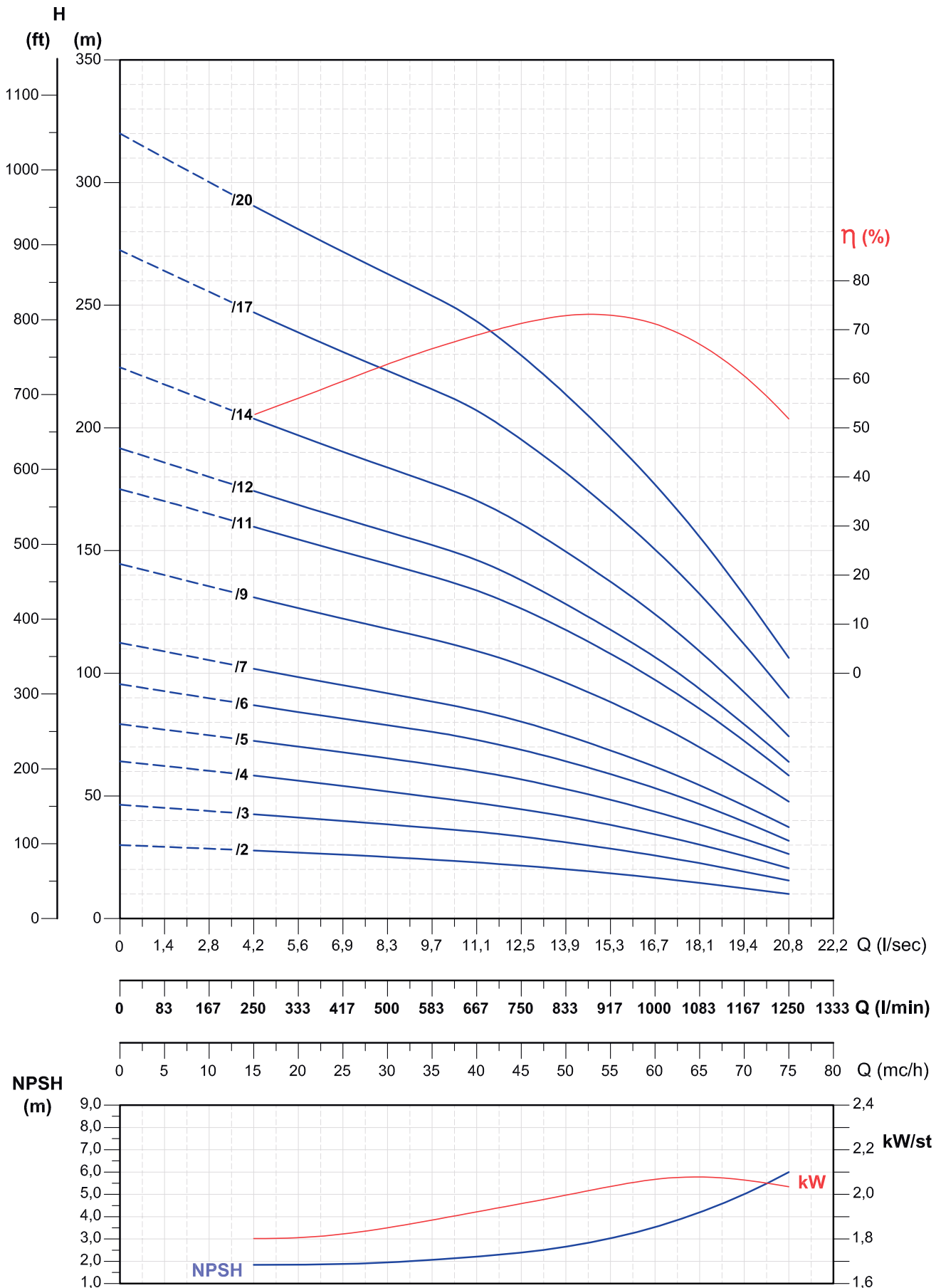

Tolleranze secondo EN ISO 9906 app.A Gr.2 - Tolerances according to EN ISO 9906 anx.A Gr.2 - Tolérances conformes EN ISO 9906 ann.A Gr.2
 Rispetta il Reg. UE n° 547/2012 con MEI = 0.40 - Comply with Reg. UE n° 547/2012 with MEI = 0.40 - Conforme Reg. UE n°547/2012 avec MEI =0.40

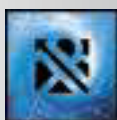

Tipo Type Type	Motore Motors 2900 g/m Moteurs		Q = Portata - Capacity - Débit									
			l/sec	0	13,9	15,3	16,7	18,1	19,5	20,8	22,2	23,6
	Cv Hp	Kw	l/min	0	833	917	1000	1083	1167	1250	1333	1417
			mc/h	0	50	55	60	65	70	75	80	85
FB6SL/2 + 6F7	7,5	5,5	H(m)	31	23	22	20	19	17	15	12	10
FB6SL/3 + 6F12	12,5	9,2		48	35	33	31	29	26	23	19	15
FB6SL/4 + 6F15	15	11		64	47	45	42	39	35	31	26	20
FB6SL/5 + 6F17	17,5	13		81	59	56	53	49	44	39	32	25
FB6SL/7 + 6F25	25	18,5		115	84	80	74	69	63	55	46	35
FB6SL/8 + 6F30	30	22		131	96	91	85	79	72	63	52	40
FB6SL/10 + 6F35	35	26		164	120	114	106	99	90	79	66	51
FB6SL/11 + 6F40*	40	30		180	132	125	117	109	99	87	72	56
FB6SL/14 + 6F50*	50	37		230	168	159	149	138	126	110	92	71
FB6SL/17 + 6F60*	60	45		279	203	193	181	168	152	134	112	86

Dimensioni e pesi

Overall dimensions and weights - Dimensions d'encombrement et poids

Tipo Type Type	Cv Hp	Kw	A (mm)	B (mm)	C (mm)	D (mm)	ø max (mm)	DN	Peso - Weight - Poids		
									A (kg)	B (kg)	C (kg)
FB6SL/2 + 6F7	7,5	5,5	1259	632	627	145	150	G 3"	76	30	46
FB6SL/3 + 6F12	12,5	9,2	1434	737	697				90	36	54
FB6SL/4 + 6F15	15	11	1609	842	767				103	42	61
FB6SL/5 + 6F17	17,5	13	1714	947	767				110	48	62
FB6SL/7 + 6F25	25	18,5	2054	1157	897				135	60	75
FB6SL/8 + 6F30	30	22	2229	1262	967				148	66	82
FB6SL/10 + 6F35	35	26	2499	1472	1027				167	78	89
FB6SL/11 + 6F40*	40	30	2744	1577	1167				187	84	103
FB6SL/14 + 6F50*	50	37	3189	1892	1297				218	102	116
FB6SL/17 + 6F60*	60	45	3534	2207	1327				241	120	121



* Non consigliata per montaggio in posizione orizzontale

* This electropump isn't recommended for horizontal assemblage

* Cette électropompe n'est pas recommandée pour le montage en position horizontale

CURVE DELLE PRESTAZIONI

PERFORMANCES' CURVES

COURBES DES PERFORMANCES

FB6SL

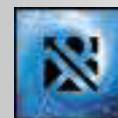

n=2900 1/min 50 Hz

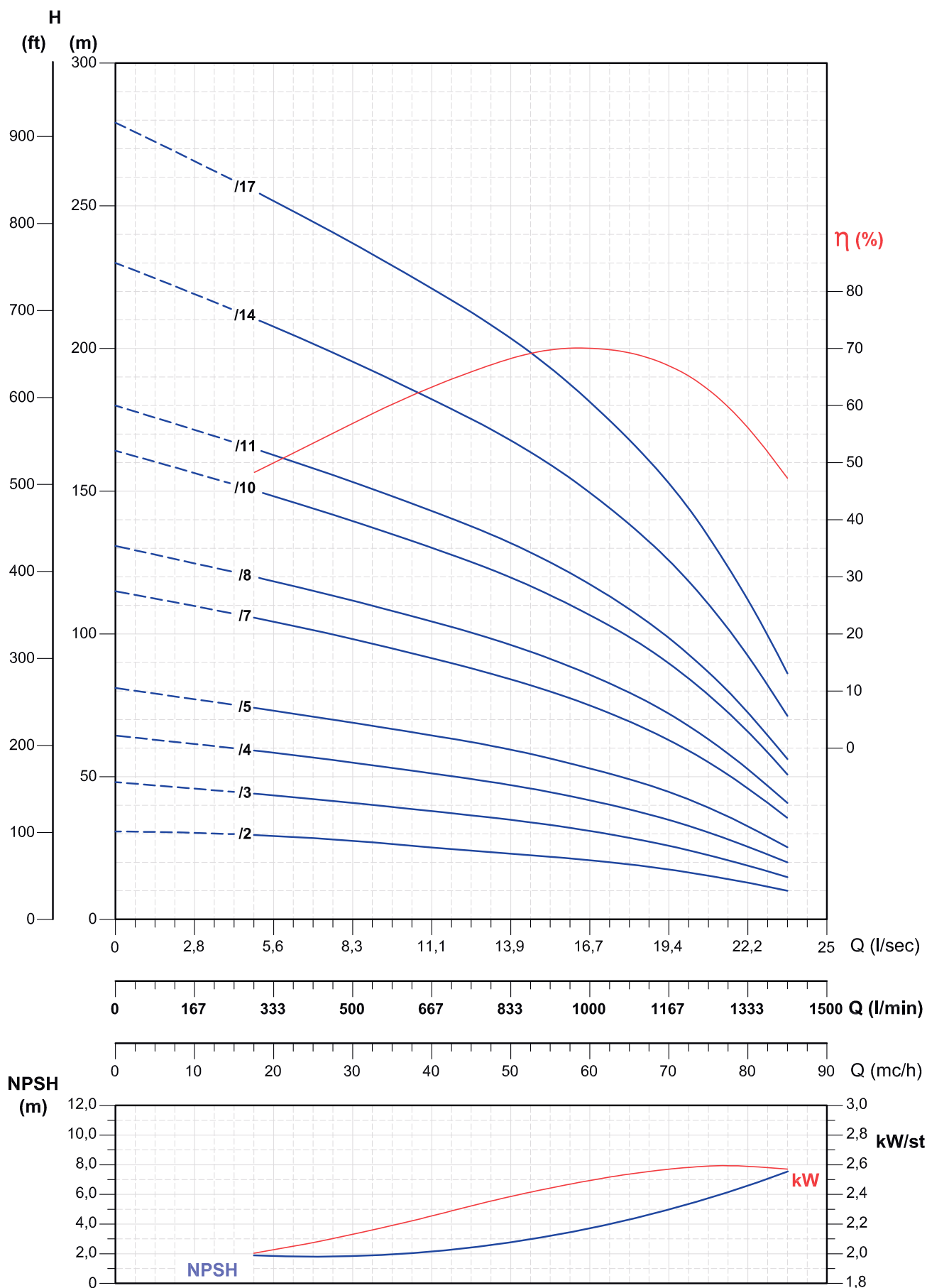

Tolleranze secondo EN ISO 9906 app.A Gr.2 - Tolerances according to EN ISO 9906 annex A Gr.2 - Tolérances conformes EN ISO 9906 ann.A Gr.2

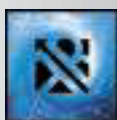

ELETTROPOMPE SOMMERSE 6" RADIALI IN ACCIAIO INOX AISI 304 E AISI 316

6" RADIAL-FLOW STAINLESS STEEL AISI 304 AND AISI 316 ELECTROPUMPS

ÉLECTROPOMPES IMMERGÉES 6" RADIALES EN ACIER INOXYDABLE AISI 304 ET AISI 316



La struttura totalmente in acciaio inossidabile con camera esterna, garantisce l'allineamento permanente di tutti i componenti che assieme agli anelli di rasamento flottanti in PTFE, le bocche di guida in ceramica, i cuscinetti scanalati in gomma conferiscono al corpo pompa una maggiore resistenza nel tempo. La gamma è stata studiata per garantire un'elevata efficienza con la riduzione del consumo di energia e quindi dei costi.

APPLICAZIONI:

- irrigazione, approvvigionamento idrico, aumento pressione, ed antincendio
- acque potabili
- acque di mare
- acque salmastre
- acque termali e sulfuree
- desalinizzazione ed osmosi
- acque aggressive e corrosive
- vari settori dell'industria: alimentare, petrolchimica, siderurgica e navale
- applicazioni gravose: miniera

Costruzione in Acciaio Inox AISI 304:

- giranti in acciaio inox AISI 304 (W. Nr. 1.4301)
- corpo di stadio in acciaio inox AISI 304 (W. Nr. 1.4301)
- bocca di mandata in acciaio inox AISI 304 (W. Nr. 1.4301)
- valvola di ritegno in acciaio inox AISI 316 (W. Nr. 1.4401)
- albero in acciaio inox AISI 431 (W. Nr. 1.4057)
- proteggi cavo in acciaio inox AISI 316 (W. Nr. 1.4401)
- griglia d'aspirazione in acciaio inox AISI 316 (W. Nr. 1.4401)
- viteria in acciaio inox AISI 304 (W. Nr. 1.4301)

Costruzione in Acciaio Inox AISI 316:

- giranti in acciaio inox AISI 316 (W. Nr. 1.4401)
- corpo di stadio in acciaio inox AISI 316 (W. Nr. 1.4401)
- bocca di mandata in acciaio inox AISI 316 (W. Nr. 1.4401)
- valvola di ritegno in acciaio inox AISI 316 (W. Nr. 1.4401)
- albero in acciaio inox AISI 316 (W. Nr. 1.4401)
- proteggi cavo in acciaio inox AISI 316 (W. Nr. 1.4401)
- griglia d'aspirazione in acciaio inox AISI 316 (W. Nr. 1.4401)
- viteria in acciaio inox AISI 316 (W. Nr. 1.4401)

CARATTERISTICHE:

- portata massima: 667 l/m
- prevalenza massima: 700 metri
- potenza massima: 45 kW
- diametro d'ingombro massimo: 145 mm (incluso il copri cavo)
- temperatura massima dell'acqua: 60°C (solo per corpo pompa, per il motore vedi catalogo motori)
- contenuto di sabbia massimo: 100 g/m³

OPTIONAL:

Su richiesta si possono fornire:

- doppio proteggi cavo
- attacco motore 4" NEMA
- attacco motore 8" NEMA



The stainless steel construction with external sleeve, assure permanent alignment of all the components together with PTFE floating neck ring, ceramic guide journal sleeve and nitrile rubber fluted bearing to ensure the pump long-lasting performances.

This range is studied to ensure efficiency at the top of the market, thus reducing energy consumption and costs.

APPLICATIONS:

- irrigation, water supply system, pressure boosting, fire-fighting systems
- drinking water
- sea water
- brackish water
- thermal and sulphurous water
- desalinization and osmosis
- aggressive and corrosive waters
- different sectors of the industry: such as food, petrochemical, steel and shipbuilding
- hard applications: mine

STAINLESS STEEL AISI 304 CONSTRUCTION:

- stainless steel AISI 304 (W. Nr. 1.4301) impellers
- stainless steel AISI 304 (W. Nr. 1.4301) diffusers
- stainless steel AISI 304 (W. Nr. 1.4301) discharge head
- stainless steel AISI 316 (W. Nr. 1.4401) retaining valve
- stainless steel AISI 431 (W. Nr. 1.4057) shaft
- stainless steel AISI 316 (W. Nr. 1.4401) cable guard
- stainless steel AISI 316 (W. Nr. 1.4401) suction strainer
- stainless steel AISI 304 (W. Nr. 1.4301) bolts and screws

STAINLESS STEEL AISI 316 CONSTRUCTION AISI:

- stainless steel AISI 316 (W. Nr. 1.4401) impellers
- stainless steel AISI 316 (W. Nr. 1.4401) diffusers
- stainless steel AISI 316 (W. Nr. 1.4401) discharge head
- stainless steel AISI 316 (W. Nr. 1.4401) retaining valve
- stainless steel AISI 316 (W. Nr. 1.4401) shaft
- stainless steel AISI 316 (W. Nr. 1.4401) cable guard
- stainless steel AISI 316 (W. Nr. 1.4401) suction strainer
- stainless steel AISI 316 (W. Nr. 1.4401) bolts and screws

FEATURES:

- maximum capacity: 667 l/m
- maximum head: 700 meters
- maximum power: 45 Kw
- maximum encumbrance diameter: 145 mm (cable cover included)
- maximum water temperature: 60°C (only for the pump, for the motor see motors' catalogue)
- maximum sand content: 100 g/m³

OPTIONAL:

On demand pumps can be supplied with:

- double cable guard
- 4" NEMA coupling
- 8" NEMA coupling

ELETTROPOMPE SOMMERSE 6" RADIALI IN ACCIAIO INOX AISI 304 E AISI 316

6" RADIAL-FLOW STAINLESS STEEL AISI 304 AND AISI 316 ELECTROPUMPS

ÉLECTROPOMPES IMMERGÉES 6" RADIALES EN ACIER INOXYDABLE AISI 304 ET AISI 316

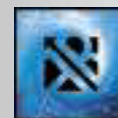

La structure en acier inoxydable avec la chemise externe, garantit l'alignement permanent de tous les composants et avec les bagues d'usure flottantes en PTFE, les douilles de guidage en céramique et les coussinets rainurés en caoutchouc confèrent à la pompe plus résistance dans les temps. La gamme a été étudiée pour garantir haute efficacité en réduisant la consommation d'énergie et donc des coûts.

APPLICATIONS:

- irrigation, installation d'approvisionnement hydrique, surpression et anti incendie
- eau potable
- eau de mer
- eau saumâtre
- eau thermale e sulfureuse
- dessalement et osmose
- eau agressive et corrosives
- différents secteurs de l'industrie : alimentaire, pétrochimie, sidérurgique et navale
- applications dures : mine

CONSTRUCTION EN AISI 304:

- roues en acier inoxydable AISI 304 (W. Nr. 1.4301)
- corps d'étage en acier inoxydable AISI 304 (W. Nr. 1.4301)
- orifice de refoulement en acier inoxydable AISI 304 (W. Nr. 1.4301)
- crépine de non-retour en acier inoxydable AISI 316 (W. Nr. 1.4401)
- arbre en acier inoxydable AISI 431 (W. Nr. 1.4057)
- couvre-câble en acier inoxydable AISI 316 (W. Nr. 1.4401)
- crépine d'aspiration en acier inoxydable AISI 316 (W. Nr. 1.4401)
- visserie en acier inoxydable AISI 304 (W. Nr. 1.4301)

CONSTRUCTION EN AISI 316:

- roues en acier inoxydable AISI 316 (W. Nr. 1.4401)
- corps d'étage en acier inoxydable AISI 316 (W. Nr. 1.4401)
- orifice de refoulement en acier inoxydable AISI 316 (W. Nr. 1.4401)
- crépine de non-retour en acier inoxydable AISI 316 (W. Nr. 1.4401)
- arbre en acier inoxydable AISI 316 (W. Nr. 1.4401)
- couvre-câble en acier inoxydable AISI 316 (W. Nr. 1.4401)
- crépine d'aspiration en acier inoxydable AISI 316 (W. Nr. 1.4401)
- visserie en acier inoxydable AISI 316 (W. Nr. 1.4401)

CARACTÉRISTIQUES:

- débit maximum: 667 l/m
- hauteur maximale: 700 mètres
- puissance maximale: 45 Kw
- diamètre d'encombrement maximum: 145 mm (inclus le couvre-câble)
- température maximale de l'eau: 60°C (pour la pompe, pour le moteur voir le catalogue des moteurs)
- quantité maximale de sable: 100 g/m³

OPTIONAL:

- Sur demande on peut fournir:
- double couvre-câble
 - accouplement moteur 4" NEMA
 - accouplement moteur 8" NEMA



NEW

AISI 304
AISI 316

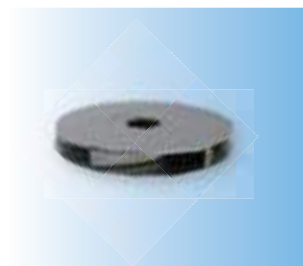

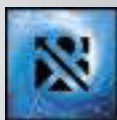

ACCOPIAMENTO MOTORE 4"
4" MOTOR COUPLINGS
ACCOUPEMENTS MOTEUR 4"

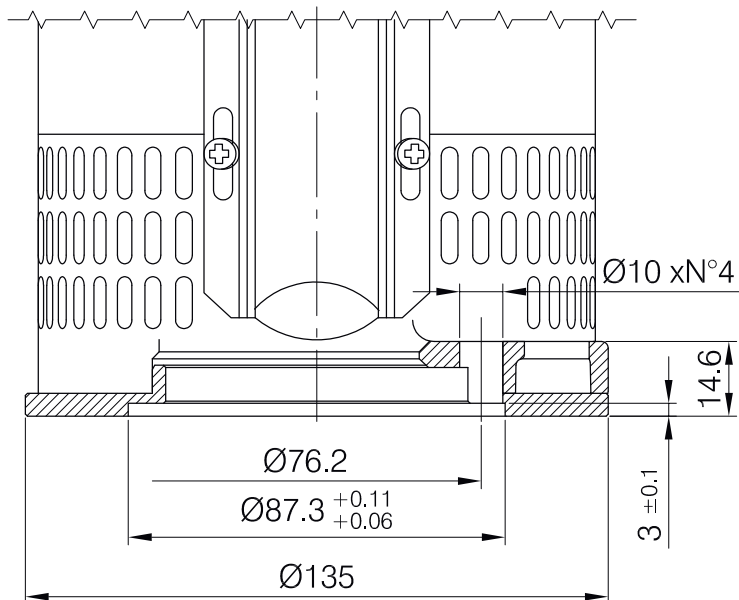

ACCOPIAMENTO MOTORE 6"
6" MOTOR COUPLINGS
ACCOUPEMENTS MOTEUR 6"

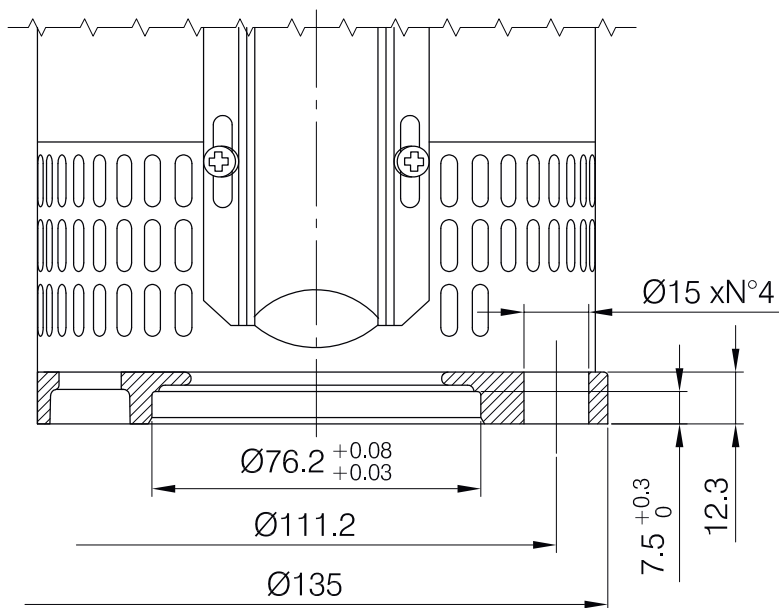

SPACCATO 6"

6" CUTAWAY

COUPE 6"

FB6RX

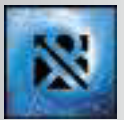

N°	Versione	AISI 304	AISI 316
	Description Description Description	Material Material Matériel	Material Material Matériel
1	Corpo di mandata Discharge head Refoulement	AISI 304	AISI 316
2	Valvola Valve Soupape	AISI 316	AISI 316
3	Anello tenuta OR O.R. ring Bague O.R.	NBR	NBR
4	Viti e dadi esterni Outer case locking nuts Vis et écrous externes	AISI 304	AISI 316
5	Supporto valvola Valve support Support de soupape	AISI 316	AISI 316
6	Anello seeger Circlip Segment d'arrêt	AISI 316	AISI 316
7	Camicia Sleeve Chemise	AISI 304	AISI 316
8	Griglia di aspirazione Suction strainer Crépine d'aspiration	AISI 316	AISI 316
9	Copricavo e viti Cable guard Protège cable	AISI 316	AISI 316
10	Distanziale iniziale Initial spacer Entrotoise	AISI 304	AISI 316
11	Flangia e bulloni Flange and screws Flange et boulon	AISI 304	AISI 316
12	Supporto di aspirazione Suction support Support d'Aspiration	AISI 304	AISI 316
13	Albero pompa Pump shaft Arbre pompe	AISI 431	AISI 316/329
14	Giunto Joint Joint	AISI 431/329	AISI 316/329
15	Disco reggispinta sup. Upper thrust washer Butée supérieure	AISI 316	AISI 316
16	Disco reggispinta inf. Lower thrust washer Butée inférieure	AISI 316	AISI 316
17	Boccola guida sup. Upper guide bush Cousinnet de guidage supérieure	AISI 329	AISI 329
18	Vite e rondella Screw and washer Vis et rondelle	AISI 316	AISI 316
19	Anello reggispinta Thrust ring Bague de butée	PTFE + grafite PTFE + graphite	PTFE + grafite PTFE + graphite
20	Distanziale inferiore Lower spacer Entrotoise inférieur	AISI 316	AISI 316
21	Distanziale superiore Upper spacer Entrotoise supérieur	AISI 316	AISI 316
22	Diffusore Diffuser Diffuseur	AISI 304	AISI 316
23	Bussola intermedia Intermediate bush Douille intermédiaire	NBR	NBR
24	Anello rasamento flottante Floating neck ring Bague d'usure flottant	PTFE	PTFE
25	Boccola cuscinetto Bearing bushing Cousinnet	PTFE	PTFE
26	Guida cuscinetto sup. Superior bearing guide Guide de palier supérieur	AISI 316	AISI 316
27	Corpo primo stadio First diffuser Premier corp d'étage	AISI 316	AISI 316
28	Corpo stadio Diffuser Corp d'étage	AISI 316	AISI 316
29	Corpo ultimo stadio Last diffuser Dernier corp d'étage	AISI 316	AISI 316
30	Girante Impeller Roue	AISI 304	AISI 316
31	Distanziale girante Impeller spacer Entrotoise roue	AISI 316	AISI 316

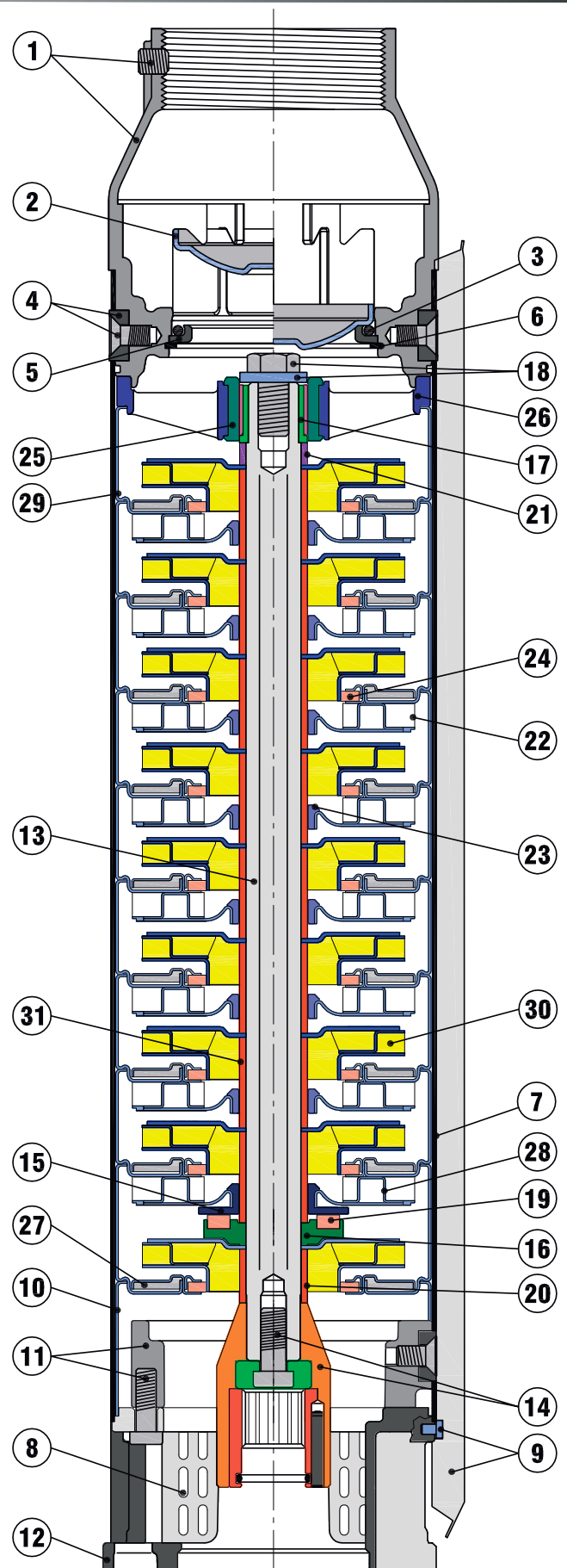



TABELLA DELLE CARATTERISTICHE IDRAULICHE 6"

6" HYDRAULIC FEATURES' CHART

TABLE DES CARACTÉRISTIQUES HYDRAULIQUES 6"

Tipo Type Type	Motore Motor Moteur		Q = Portata - Capacity - Débit																
			l/sec	0	0,8	1,3	1,7	2,2	2,8	3,3	4,2	5,0							
	l/min	0	50	75	100	133	167	200	250	300									
	Hp	kW	mc/h	0	3	5	6	8	10	12	15	18							
FB6RX13/4	3	2,2		45	43	41	41	39	36	33	25	15							
FB6RX13/5	3	2,2		56	53	52	51	48	45	41	31	19							
FB6RX13/6	4	3		67	64	62	61	58	55	50	38	22							
FB6RX13/7	4	3		79	75	72	71	68	64	58	44	26							
FB6RX13/8	5,5	4		90	85	83	81	78	73	66	50	30							
FB6RX13/9	5,5	4		101	96	93	91	87	82	75	56	33							
FB6RX13/10	7,5	5,5		112	107	103	101	97	91	83	63	37							
FB6RX13/11	7,5	5,5		123	117	113	112	107	100	91	69	41							
FB6RX13/12	7,5	5,5		135	128	124	122	116	109	100	75	45							
FB6RX13/13	7,5	5,5		146	139	134	132	126	118	108	81	48							
FB6RX13/14	10	7,5		157	149	144	142	136	127	116	88	52							
FB6RX13/15	10	7,5		168	160	155	152	145	136	124	94	56							
FB6RX13/16	10	7,5		179	171	165	162	155	145	133	100	59							
FB6RX13/17	10	7,5		191	181	175	172	165	155	141	106	63							
FB6RX13/18	12,5	9,2	H(m)	202	192	186	183	174	164	149	113	67							
FB6RX13/19	12,5	9,2		213	203	196	193	184	173	158	119	71							
FB6RX13/20	12,5	9,2		224	214	206	203	194	182	166	125	74							
FB6RX13/21	12,5	9,2		236	224	217	213	203	191	174	131	78							
FB6RX13/22	12,5	9,2		247	235	227	223	213	200	182	138	82							
FB6RX13/23	15	11		258	246	237	233	223	209	191	144	85							
FB6RX13/24	15	11		269	256	248	243	233	218	199	150	89							
FB6RX13/25	15	11		280	267	258	253	242	227	207	156	93							
FB6RX13/26	15	11		292	278	268	264	252	236	216	163	97							
FB6RX13/27	17,5	13		303	288	279	274	262	245	224	169	100							
FB6RX13/28	17,5	13		314	299	289	284	271	255	232	175	104							
FB6RX13/29	17,5	13		325	310	299	294	281	264	240	181	108							
FB6RX13/30	17,5	13		336	320	309	304	291	273	249	188	111							
FB6RX13/31	20	15		348	331	320	314	300	282	257	194	115							
FB6RX13/32	20	15		359	342	330	324	310	291	265	200	119							

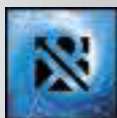
TABELLA DELLE CARATTERISTICHE IDRAULICHE 6"

6" HYDRAULIC FEATURES' CHART

TABLE DES CARACTÉRISTIQUES HYDRAULIQUES 6"

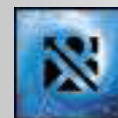

Tipo Type Type	Motore Motor Moteur		Q = Portata - Capacity - Débit																
			l/sec	0	0,8	1,3	1,7	2,2	2,8	3,3	4,2	5,0							
	l/min	0	50	75	100	133	167	200	250	300									
	Hp	kW	mc/h	0	3	5	6	8	10	12	15	18							
FB6RX13/33	20	15		370	352	340	335	320	300	274	206	123							
FB6RX13/34	20	15		381	363	351	345	329	309	282	213	126							
FB6RX13/35	20	15		392	374	361	355	339	318	290	219	130							
FB6RX13/36	20	15		404	384	371	365	349	327	298	225	134							
FB6RX13/37	25	18,5		415	395	382	375	358	336	307	231	137							
FB6RX13/38	25	18,5		426	406	392	385	368	345	315	238	141							
FB6RX13/39	25	18,5		437	416	402	395	378	354	323	244	145							
FB6RX13/40	25	18,5		449	427	413	406	388	364	332	250	149							
FB6RX13/41	25	18,5		460	438	423	416	397	373	340	256	152							
FB6RX13/42	25	18,5		471	448	433	426	407	382	348	263	156							
FB6RX13/43	25	18,5		482	459	444	436	417	391	356	269	160							
FB6RX13/44	25	18,5		493	470	454	446	426	400	365	275	163							
FB6RX13/45	30	22		505	480	464	456	436	409	373	281	167							
FB6RX13/46	30	22		516	491	475	466	446	418	381	288	171							
FB6RX13/47	30	22	H(m)	527	502	485	477	455	427	390	294	175							
FB6RX13/48	30	22		538	512	495	487	465	436	398	300	178							
FB6RX13/49	30	22		549	523	505	497	475	445	406	306	182							
FB6RX13/50	30	22		561	534	516	507	484	454	414	313	186							
FB6RX13/51	30	22		572	544	526	517	494	464	423	319	189							
FB6RX13/52	30	22		583	555	537	527	504	473	431	325	193							
FB6RX13/53	35	26		594	566	547	537	513	482	439	331	197							
FB6RX13/54	35	26		606	576	557	547	523	491	448	338	201							
FB6RX13/55	35	26		617	587	567	558	533	500	456	344	204							
FB6RX13/56	35	26		628	598	578	568	543	509	464	350	208							
FB6RX13/57	35	26		639	608	588	578	552	518	472	356	212							
FB6RX13/58	35	26		650	619	598	588	562	527	481	363	215							
FB6RX13/59	35	26		662	630	609	598	572	536	489	369	219							
FB6RX13/60	35	26		673	641	619	608	581	545	497	375	223							
FB6RX13/61	35	26		684	651	629	618	591	554	506	381	227							



TABELLA DELLE CARATTERISTICHE IDRAULICHE 6"

6" HYDRAULIC FEATURES' CHART

TABLE DES CARACTÉRISTIQUES HYDRAULIQUES 6"

Tipo Type Type	Motore Motor Moteur		Q = Portata - Capacity - Débit																
			l/sec	0	0,8	1,7	2,2	2,8	3,3	4,2	5,0	5,8	6,7	7,5					
	l/min	0	50	100	133	167	200	250	300	350	400	450							
	Hp	kW	mc/h	0	3	6	8	10	12	15	18	21	24	27					
FB6RX20/3	3	2,2		35		34	33	32	31	29	26	22	16	10					
FB6RX20/4	4	3		47		45	44	43	41	38	34	29	22	14					
FB6RX20/5	5,5	4		58		56	55	53	52	48	43	36	27	17					
FB6RX20/6	5,5	4		70		67	66	64	62	58	52	43	33	21					
FB6RX20/7	7,5	5,5		82		79	78	75	72	67	60	50	38	24					
FB6RX20/8	7,5	5,5		93		90	89	85	83	77	69	58	44	27					
FB6RX20/9	7,5	5,5		105		101	100	96	93	86	77	65	49	31					
FB6RX20/10	10	7,5		117		112	111	107	103	96	86	72	55	34					
FB6RX20/11	10	7,5		128		123	122	117	114	106	95	79	60	38					
FB6RX20/12	10	7,5		140		135	133	128	124	115	103	86	66	41					
FB6RX20/13	12,5	9,2		152		146	144	139	134	125	112	94	71	45					
FB6RX20/14	12,5	9,2		163		157	155	149	145	134	120	101	77	48					
FB6RX20/15	12,5	9,2		175		168	166	160	155	144	129	108	82	51					
FB6RX20/16	15	11		187		180	177	171	165	154	138	115	88	55					
FB6RX20/17	15	11	H(m)	198		191	188	181	176	163	146	122	93	58					
FB6RX20/18	15	11		210		202	199	192	186	173	155	130	99	62					
FB6RX20/19	17,5	13		222		213	210	203	196	182	163	137	104	65					
FB6RX20/20	17,5	13		233		224	221	213	207	192	172	144	110	68					
FB6RX20/21	17,5	13		245		236	232	224	217	202	181	151	115	72					
FB6RX20/22	20	15		257		247	244	235	227	211	189	158	121	75					
FB6RX20/23	20	15		268		258	255	245	238	221	198	166	126	79					
FB6RX20/24	20	15		280		269	266	256	248	230	206	173	132	82					
FB6RX20/25	25	18,5		292		280	277	267	258	240	215	180	137	86					
FB6RX20/26	25	18,5		303		292	288	277	269	250	224	187	143	89					
FB6RX20/27	25	18,5		315		303	299	288	279	259	232	194	148	92					
FB6RX20/28	25	18,5		327		314	310	299	289	269	241	202	154	96					
FB6RX20/29	25	18,5		338		325	321	309	300	278	249	209	159	99					
FB6RX20/30	25	18,5		350		337	332	320	310	288	258	216	165	103					
FB6RX20/31	30	22		362		348	343	331	320	298	267	223	170	106					

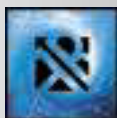
TABELLA DELLE CARATTERISTICHE IDRAULICHE 6"

6" HYDRAULIC FEATURES' CHART

TABLE DES CARACTÉRISTIQUES HYDRAULIQUES 6"



Tipo Type Type	Motore Motor Moteur		Q = Portata - Capacity - Débit																		
			l/sec	0	0,8	1,7	2,2	2,8	3,3	4,2	5,0	5,8	6,7	7,5							
	l/min	0	50	100	133	167	200	250	300	350	400	450									
	Hp	kW	mc/h	0	3	6	8	10	12	15	18	21	24	27							
FB6RX20/32	30	22		373		359	354	341	331	307	275	230	176	109							
FB6RX20/33	30	22		385		370	365	352	341	317	284	238	181	113							
FB6RX20/34	30	22		397		381	376	363	351	326	292	245	187	116							
FB6RX20/35	30	22		408		393	387	373	362	336	301	252	192	120							
FB6RX20/36	30	22		420		404	398	384	372	346	310	259	198	123							
FB6RX20/37	35	26		432		415	410	395	382	355	318	266	203	127							
FB6RX20/38	35	26		443		426	421	405	393	365	327	274	209	130							
FB6RX20/39	35	26		455		437	432	416	403	374	335	281	214	133							
FB6RX20/40	35	26		467		449	443	427	413	384	344	288	220	137							
FB6RX20/41	35	26		478		460	454	437	424	394	353	295	225	140							
FB6RX20/42	35	26		490		471	465	448	434	403	361	302	230	144							
FB6RX20/43	40	30		502		482	476	459	444	413	370	310	236	147							
FB6RX20/44	40	30		513		494	487	469	455	422	378	317	241	151							
FB6RX20/45	40	30		525		505	498	480	465	432	387	324	247	154							
FB6RX20/46	40	30	H(m)	537		516	509	491	475	442	396	331	252	157							
FB6RX20/47	40	30		548		527	520	501	486	451	404	338	258	161							
FB6RX20/48	40	30		560		538	531	512	496	461	413	346	263	164							
FB6RX20/49	40	30		572		550	542	523	506	470	421	353	269	168							
FB6RX20/50	50	37		583		561	553	533	517	480	430	360	274	171							
FB6RX20/51	50	37		595		572	564	544	527	490	439	367	280	174							
FB6RX20/52	50	37		607		583	576	555	537	499	447	374	285	178							
FB6RX20/53	50	37		618		594	587	565	548	509	456	382	291	181							
FB6RX20/54	50	37		630		606	598	576	558	518	464	389	296	185							
FB6RX20/55	50	37		642		617	609	587	568	528	473	396	302	188							
FB6RX20/56	50	37		653		628	620	597	579	538	482	403	307	192							
FB6RX20/57	50	37		665		639	631	608	589	547	490	410	313	195							
FB6RX20/58	50	37		677		651	642	619	599	557	499	418	318	198							
FB6RX20/59	50	37		688		662	653	629	610	566	507	425	324	202							
FB6RX20/60	50	37		700		673	664	640	620	576	516	432	329	205							



TABELLA DELLE CARATTERISTICHE IDRAULICHE 6"

6" HYDRAULIC FEATURES' CHART

TABLE DES CARACTÉRISTIQUES HYDRAULIQUES 6"

Tipo Type Type	Motore Motor Moteur		Q = Portata - Capacity - Débit																	
			l/sec	0	2,2	3,3	4,4	5,6	6,7	7,8	8,9	10,0	11,1							
	l/min	0	133	200	267	333	400	467	533	600	667									
	Hp	kW	mc/h	0	8	12	16	20	24	28	32	36	40							
FB6RX28/2	3	2,2		24		22	22	20	19	17	14	11	8							
FB6RX28/3	4	3		36		34	33	31	29	25	21	17	12							
FB6RX28/4	5,5	4		48		45	44	41	38	33	28	23	16							
FB6RX28/5	7,5	5,5		61		56	55	51	48	42	35	29	20							
FB6RX28/6	10	7,5		73		67	66	62	57	50	42	34	24							
FB6RX28/7	10	7,5		85		79	77	72	67	59	49	40	28							
FB6RX28/8	12,5	9,2		97		90	88	82	76	67	56	46	32							
FB6RX28/9	12,5	9,2		109		101	99	92	86	75	63	51	36							
FB6RX28/10	15	11		121		112	109	102	95	84	70	57	40							
FB6RX28/11	15	11		133		124	120	113	105	92	77	63	44							
FB6RX28/12	17,5	13		145		135	131	123	114	100	84	68	48							
FB6RX28/13	17,5	13	H(m)	157		146	142	133	124	109	91	74	52							
FB6RX28/14	20	15		169		157	153	143	133	117	98	80	56							
FB6RX28/15	20	15		182		168	164	154	143	125	105	86	60							
FB6RX28/16	25	18,5		194		180	175	164	152	134	112	91	64							
FB6RX28/17	25	18,5		206		191	186	174	162	142	119	97	68							
FB6RX28/18	25	18,5		218		202	197	184	171	150	126	103	72							
FB6RX28/19	25	18,5		230		213	208	195	180	159	133	108	76							
FB6RX28/20	30	22		242		225	219	205	190	167	140	114	80							
FB6RX28/21	30	22		254		236	230	215	200	176	147	120	84							
FB6RX28/22	30	22		266		247	241	225	209	184	154	125	88							
FB6RX28/23	30	22		278		258	252	236	219	192	161	131	92							

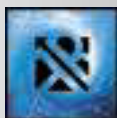
TABELLA DELLE CARATTERISTICHE IDRAULICHE 6"

6" HYDRAULIC FEATURES' CHART

TABLE DES CARACTÉRISTIQUES HYDRAULIQUES 6"

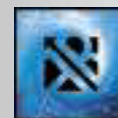

Tipo Type Type	Motore Motor Moteur		Q = Portata - Capacity - Débit																	
			l/sec	0	2,2	3,3	4,4	5,6	6,7	7,8	8,9	10,0	11,1							
	l/min	0	133	200	267	333	400	467	533	600	667									
	Hp	kW	mc/h	0	8	12	16	20	24	28	32	36	40							
FB6RX28/24	35	26		290			270	263	246	228	200	168	137	96						
FB6RX28/25	35	26		303			281	274	256	238	209	175	143	100						
FB6RX28/26	35	26		315			292	285	266	247	217	182	148	104						
FB6RX28/27	35	26		327			303	296	277	257	226	189	154	108						
FB6RX28/28	40	30		339			315	306	287	266	234	196	160	112						
FB6RX28/29	40	30		351			326	317	297	276	242	203	165	116						
FB6RX28/30	40	30		363			337	328	307	285	251	210	171	120						
FB6RX28/31	40	30		375			348	339	318	295	259	217	177	124						
FB6RX28/32	50	37		387			359	350	328	305	267	224	182	128						
FB6RX28/33	50	37		399			371	361	338	314	276	231	188	132						
FB6RX28/34	50	37		411			382	372	348	324	284	238	194	136						
FB6RX28/35	50	37	H(m)	424			393	383	359	333	293	245	200	140						
FB6RX28/36	50	37		436			404	394	369	343	301	252	205	144						
FB6RX28/37	50	37		448			416	405	379	352	309	259	211	148						
FB6RX28/38	50	37		460			427	416	389	362	318	266	217	152						
FB6RX28/39	60	45		472			438	427	400	371	326	273	222	156						
FB6RX28/40	60	45		484			449	438	410	381	334	280	228	160						
FB6RX28/41	60	45		496			461	449	420	390	343	287	234	164						
FB6RX28/42	60	45		508			472	460	430	400	351	294	239	168						
FB6RX28/43	60	45		520			483	471	440	409	359	301	245	172						
FB6RX28/44	60	45		532			494	482	451	419	368	308	251	176						
FB6RX28/45	60	45		545			505	492	461	428	376	315	257	180						
FB6RX28/46	60	45		557			517	503	471	438	384	322	262	184						

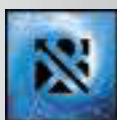

FB6RX13

DATI DELLE PRESTAZIONI
PERFORMANCES' DATA
DONNÉES DES PERFORMANCES

Tipo Type Type	Motore Motors 2900 g/m Moteurs		Q = Portata - Capacity - Débit											
			Cv Hp	Kw	l/sec	0	0,8	1,3	1,7	2,2	2,8	3,3	4,2	5,0
					l/min	0	50	75	100	133	167	200	250	300
					mc/h	0	3	5	6	8	10	12	15	18
FB6RX13/4 + 4B3	3	2,2	45	43	41	41	39	36	33	25	15			
FB6RX13/5 + 4B3	3	2,2	56	53	52	51	48	45	41	31	19			
FB6RX13/6 + 4B4	4	3	67	64	62	61	58	55	50	38	22			
FB6RX13/7 + 4B4	4	3	79	75	72	71	68	64	58	44	26			
FB6RX13/8 + 6F5	5,5	4	90	85	83	81	78	73	66	50	30			
FB6RX13/9 + 6F5	5,5	4	101	96	93	91	87	82	75	56	33			
FB6RX13/10 + 6F7	7,5	5,5	112	107	103	101	97	91	83	63	37			
FB6RX13/11 + 6F7	7,5	5,5	123	117	113	112	107	100	91	69	41			
FB6RX13/12 + 6F7	7,5	5,5	135	128	124	122	116	109	100	75	45			
FB6RX13/13 + 6F7	7,5	5,5	146	139	134	132	126	118	108	81	48			
FB6RX13/14 + 6F10	10	7,5	157	149	144	142	136	127	116	88	52			
FB6RX13/15 + 6F10	10	7,5	168	160	155	152	145	136	124	94	56			
FB6RX13/16 + 6F10	10	7,5	179	171	165	162	155	145	133	100	59			
FB6RX13/17 + 6F10	10	7,5	191	181	175	172	165	155	141	106	63			
FB6RX13/18 + 6F12	12,5	9,2	202	192	186	183	174	164	149	113	67			
FB6RX13/19 + 6F12	12,5	9,2	213	203	196	193	184	173	158	119	71			
FB6RX13/20 + 6F12	12,5	9,2	224	214	206	203	194	182	166	125	74			
FB6RX13/21 + 6F12	12,5	9,2	236	224	217	213	203	191	174	131	78			
FB6RX13/22 + 6F12	12,5	9,2	247	235	227	223	213	200	182	138	82			
FB6RX13/23 + 6F15	15	11	258	246	237	233	223	209	191	144	85			
FB6RX13/24 + 6F15	15	11	269	256	248	243	233	218	199	150	89			
FB6RX13/25 + 6F15	15	11	280	267	258	253	242	227	207	156	93			
FB6RX13/26 + 6F15	15	11	292	278	268	264	252	236	216	163	97			
FB6RX13/27 + 6F17	17,5	13	303	288	279	274	262	245	224	169	100			
FB6RX13/28 + 6F17	17,5	13	314	299	289	284	271	255	232	175	104			
FB6RX13/29 + 6F17	17,5	13	325	310	299	294	281	264	240	181	108			
FB6RX13/30 + 6F17	17,5	13	336	320	309	304	291	273	249	188	111			
FB6RX13/31 + 6F20	20	15	348	331	320	314	300	282	257	194	115			
FB6RX13/32 + 6F20	20	15	359	342	330	324	310	291	265	200	119			



Dimensioni e pesi

Overall dimensions and weights - Dimensions d'encombrement et poids

Tipo Type Type	Cv Hp	Kw	A (mm)	B (mm)	C (mm)	D (mm)	ø max (mm)	DN	Peso - Weight - Poids		
									A (kg)	B (kg)	C (kg)
									FB6RX13/4 + 4B3	3	2,2
FB6RX13/5 + 4B3	3	2,2	861	411	450	23	11	12			
FB6RX13/6 + 4B4	4	3	946	441	505	145	145	25	12	13	
FB6RX13/7 + 4B4	4	3	976	471	505			26	13	13	
FB6RX13/8 + 6F5	5,5	4	1098	501	597			58	14	44	
FB6RX13/9 + 6F5	5,5	4	1128	531	597			59	15	44	
FB6RX13/10 + 6F7	7,5	5,5	1188	561	627			62	16	46	
FB6RX13/11 + 6F7	7,5	5,5	1218	591	627			62	16	46	
FB6RX13/12 + 6F7	7,5	5,5	1248	621	627			63	17	46	
FB6RX13/13 + 6F7	7,5	5,5	1278	651	627			64	18	46	
FB6RX13/14 + 6F10	10	7,5	1348	681	667			69	19	50	
FB6RX13/15 + 6F10	10	7,5	1378	711	667			70	20	50	
FB6RX13/16 + 6F10	10	7,5	1408	741	667			71	21	50	
FB6RX13/17 + 6F10	10	7,5	1438	771	667			71	21	50	
FB6RX13/18 + 6F12	12,5	9,2	1498	801	697			76	22	54	
FB6RX13/19 + 6F12	12,5	9,2	1528	831	697			77	23	54	
FB6RX13/20 + 6F12	12,5	9,2	1558	861	697			78	24	54	
FB6RX13/21 + 6F12	12,5	9,2	1588	891	697			79	25	54	
FB6RX13/22 + 6F12	12,5	9,2	1618	921	697			80	26	54	
FB6RX13/23 + 6F15	15	11	1718	951	767			87	26	61	
FB6RX13/24 + 6F15	15	11	1748	981	767			88	27	61	
FB6RX13/25 + 6F15	15	11	1778	1011	767			89	28	61	
FB6RX13/26 + 6F15	15	11	1808	1041	767	90	29	61			
FB6RX13/27 + 6F17	17,5	13	1838	1071	767	92	30	62			
FB6RX13/28 + 6F17	17,5	13	1868	1101	767	93	31	62			
FB6RX13/29 + 6F17	17,5	13	1898	1131	767	93	31	62			
FB6RX13/30 + 6F17	17,5	13	1928	1161	767	94	32	62			
FB6RX13/31 + 6F20	20	15	2018	1191	827	101	33	68			
FB6RX13/32 + 6F20	20	15	2048	1221	827	102	34	68			

Tolleranze secondo EN ISO 9906 app.A Gr.2 - Tolerances according to EN ISO 9906 anx.A Gr.2 - Tolérances conformes EN ISO 9906 ann.A Gr.2
Rispetta il Reg. UE n° 547/2012 con MEI = 0.40 - Comply with Reg. UE n° 547/2012 with MEI = 0.40 - Conforme Reg. UE n°547/2012 avec MEI =0.40

CURVE DELLE PRESTAZIONI

PERFORMANCES' CURVES

COURBES DES PERFORMANCES

FB6RX13

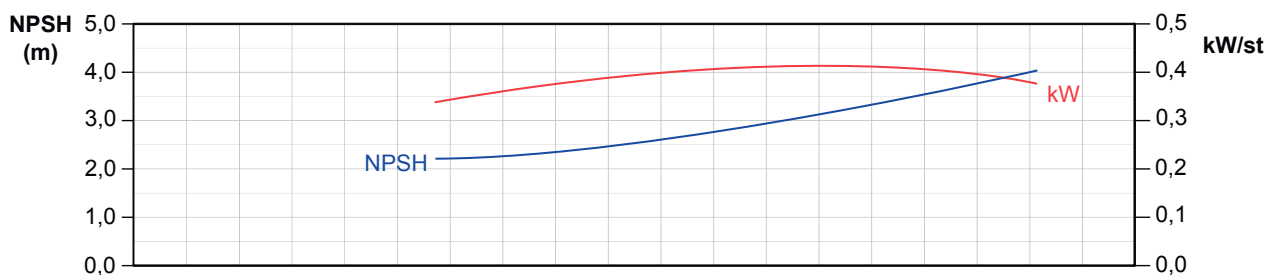
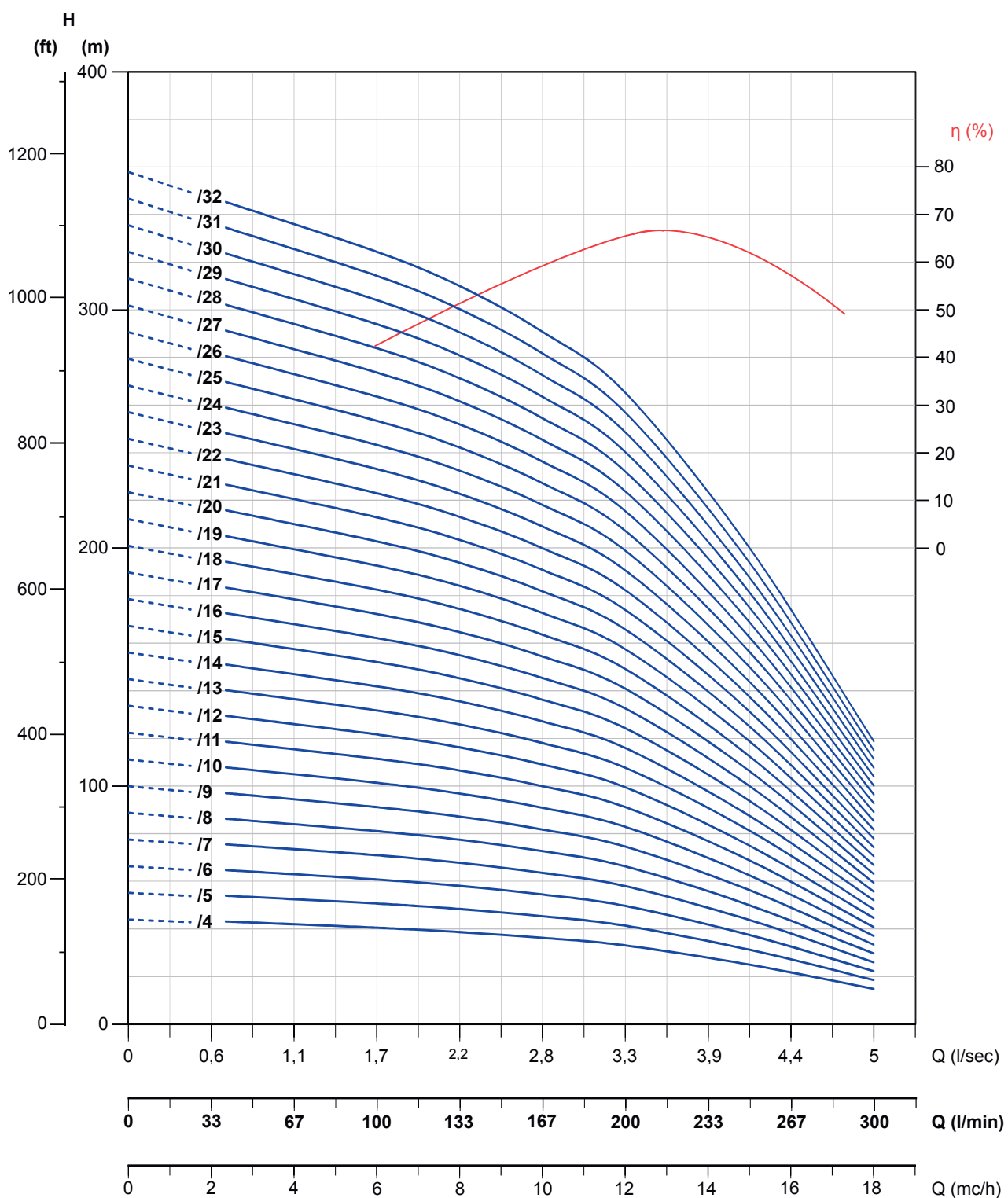
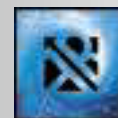

Tolleranze secondo EN ISO 9906 app.A Gr.2 - Tolerances according to EN ISO 9906 anx.A Gr.2 - Tolérances conformes EN ISO 9906 ann.A Gr.2
 Rispetta il Reg. UE n° 547/2012 con MEI = 0.40 - Comply with Reg. UE n° 547/2012 with MEI = 0.40 - Conforme Reg. UE n°547/2012 avec MEI =0.40

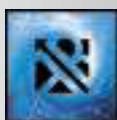

FB6RX13

DATI DELLE PRESTAZIONI
PERFORMANCES' DATA
DONNÉES DES PERFORMANCES

Tipo Type Type	Motore Motors 2900 g/m Moteurs		Q = Portata - Capacity - Débit									
	Cv Hp	Kw	l/sec	0	0,8	1,3	1,7	2,2	2,8	3,3	4,2	5,0
			l/min	0	50	75	100	133	167	200	250	300
			mc/h	0	3	5	6	8	10	12	15	18
FB6RX13/33 + 6F20	20	15		370	352	340	335	320	300	274	206	123
FB6RX13/34 + 6F20	20	15		381	363	351	345	329	309	282	213	126
FB6RX13/35 + 6F20	20	15		392	374	361	355	339	318	290	219	130
FB6RX13/36 + 6F20	20	15		404	384	371	365	349	327	298	225	134
FB6RX13/37 + 6F25	25	18,5		415	395	382	375	358	336	307	231	137
FB6RX13/38 + 6F25	25	18,5		426	406	392	385	368	345	315	238	141
FB6RX13/39 + 6F25	25	18,5		437	416	402	395	378	354	323	244	145
FB6RX13/40 + 6F25	25	18,5		449	427	413	406	388	364	332	250	149
FB6RX13/41 + 6F25	25	18,5		460	438	423	416	397	373	340	256	152
FB6RX13/42 + 6F25	25	18,5		471	448	433	426	407	382	348	263	156
FB6RX13/43 + 6F25	25	18,5		482	459	444	436	417	391	356	269	160
FB6RX13/44 + 6F25	25	18,5		493	470	454	446	426	400	365	275	163
FB6RX13/45 + 6F30	30	22		505	480	464	456	436	409	373	281	167
FB6RX13/46 + 6F30	30	22		516	491	475	466	446	418	381	288	171
FB6RX13/47 + 6F30	30	22	H (m)	527	502	485	477	455	427	390	294	175
FB6RX13/48 + 6F30	30	22		538	512	495	487	465	436	398	300	178
FB6RX13/49 + 6F30	30	22		549	523	505	497	475	445	406	306	182
FB6RX13/50 + 6F30	30	22		561	534	516	507	484	454	414	313	186
FB6RX13/51 + 6F30	30	22		572	544	526	517	494	464	423	319	189
FB6RX13/52 + 6F30	30	22		583	555	537	527	504	473	431	325	193
FB6RX13/53 + 6F35	35	26		594	566	547	537	513	482	439	331	197
FB6RX13/54 + 6F35	35	26		606	576	557	547	523	491	448	338	201
FB6RX13/55 + 6F35	35	26		617	587	567	558	533	500	456	344	204
FB6RX13/56 + 6F35	35	26		628	598	578	568	543	509	464	350	208
FB6RX13/57 + 6F35	35	26		639	608	588	578	552	518	472	356	212
FB6RX13/58 + 6F35	35	26		650	619	598	588	562	527	481	363	215
FB6RX13/59 + 6F35	35	26		662	630	609	598	572	536	489	369	219
FB6RX13/60 + 6F35	35	26		673	641	619	608	581	545	497	375	223
FB6RX13/61 + 6F35	35	26		684	651	629	618	591	554	506	381	227



Dimensioni e pesi

Overall dimensions and weights - Dimensions d'encombrement et poids

Tipo Type Type	Cv Hp	Kw	A (mm)	B (mm)	C (mm)	D (mm)	ø max (mm)	DN	Peso - Weight - Poids		
									A (kg)	B (kg)	C (kg)
FB6RX13/33 + 6F20	20	15	2151	1251	827	145	145	G 2"1/2	103	35	68
FB6RX13/34 + 6F20	20	15	2108	1281	827				103	35	68
FB6RX13/35 + 6F20	20	15	2138	1311	827				104	36	68
FB6RX13/36 + 6F20	20	15	2168	1341	827				105	37	68
FB6RX13/37 + 6F25	25	18,5	2268	1371	897				113	38	75
FB6RX13/38 + 6F25	25	18,5	2298	1401	897				114	39	75
FB6RX13/39 + 6F25	25	18,5	2328	1431	897				115	40	75
FB6RX13/40 + 6F25	25	18,5	2358	1461	897				115	40	75
FB6RX13/41 + 6F25	25	18,5	2388	1491	897				116	41	75
FB6RX13/42 + 6F25	25	18,5	2418	1521	897				117	42	75
FB6RX13/43 + 6F25	25	18,5	2448	1551	897				118	43	75
FB6RX13/44 + 6F25	25	18,5	2478	1581	897				119	44	75
FB6RX13/45 + 6F30	30	22	2578	1611	967				127	45	82
FB6RX13/46 + 6F30	30	22	2608	1641	967				127	45	82
FB6RX13/47 + 6F30	30	22	2638	1671	967				128	46	82
FB6RX13/48 + 6F30	30	22	2667	1700	967				129	47	82
FB6RX13/49 + 6F30	30	22	2698	1731	967				130	48	82
FB6RX13/50 + 6F30	30	22	2728	1761	967				131	49	82
FB6RX13/51 + 6F30	30	22	2758	1791	967				132	50	82
FB6RX13/52 + 6F30	30	22	2788	1821	967				133	51	82
FB6RX13/53 + 6F35	35	26	2878	1851	1027				141	52	89
FB6RX13/54 + 6F35	35	26	2908	1881	1027				142	53	89
FB6RX13/55 + 6F35	35	26	2938	1911	1027				142	53	89
FB6RX13/56 + 6F35	35	26	2968	1941	1027				143	54	89
FB6RX13/57 + 6F35	35	26	2998	1971	1027				144	55	89
FB6RX13/58 + 6F35	35	26	3027	2000	1027				145	56	89
FB6RX13/59 + 6F35	35	26	3057	2030	1027				146	57	89
FB6RX13/60 + 6F35	35	26	3087	2060	1027				147	58	89
FB6RX13/61 + 6F35	35	26	3117	2090	1027				147	58	89

Tolleranze secondo EN ISO 9906 app.A Gr.2 - Tolerances according to EN ISO 9906 anx.A Gr.2 - Tolérances conformes EN ISO 9906 ann.A Gr.2
Rispetta il Reg. UE n° 547/2012 con MEI = 0.40 - Comply with Reg. UE n° 547/2012 with MEI = 0.40 - Conforme Reg. UE n°547/2012 avec MEI =0.40

CURVE DELLE PRESTAZIONI

PERFORMANCES' CURVES

COURBES DES PERFORMANCES

FB6RX13

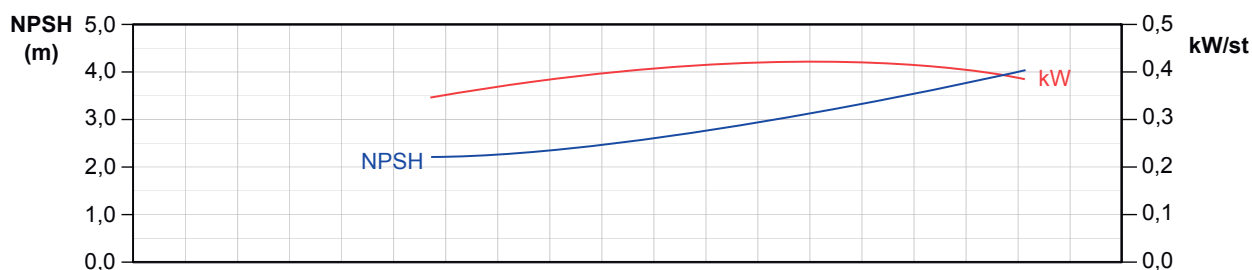
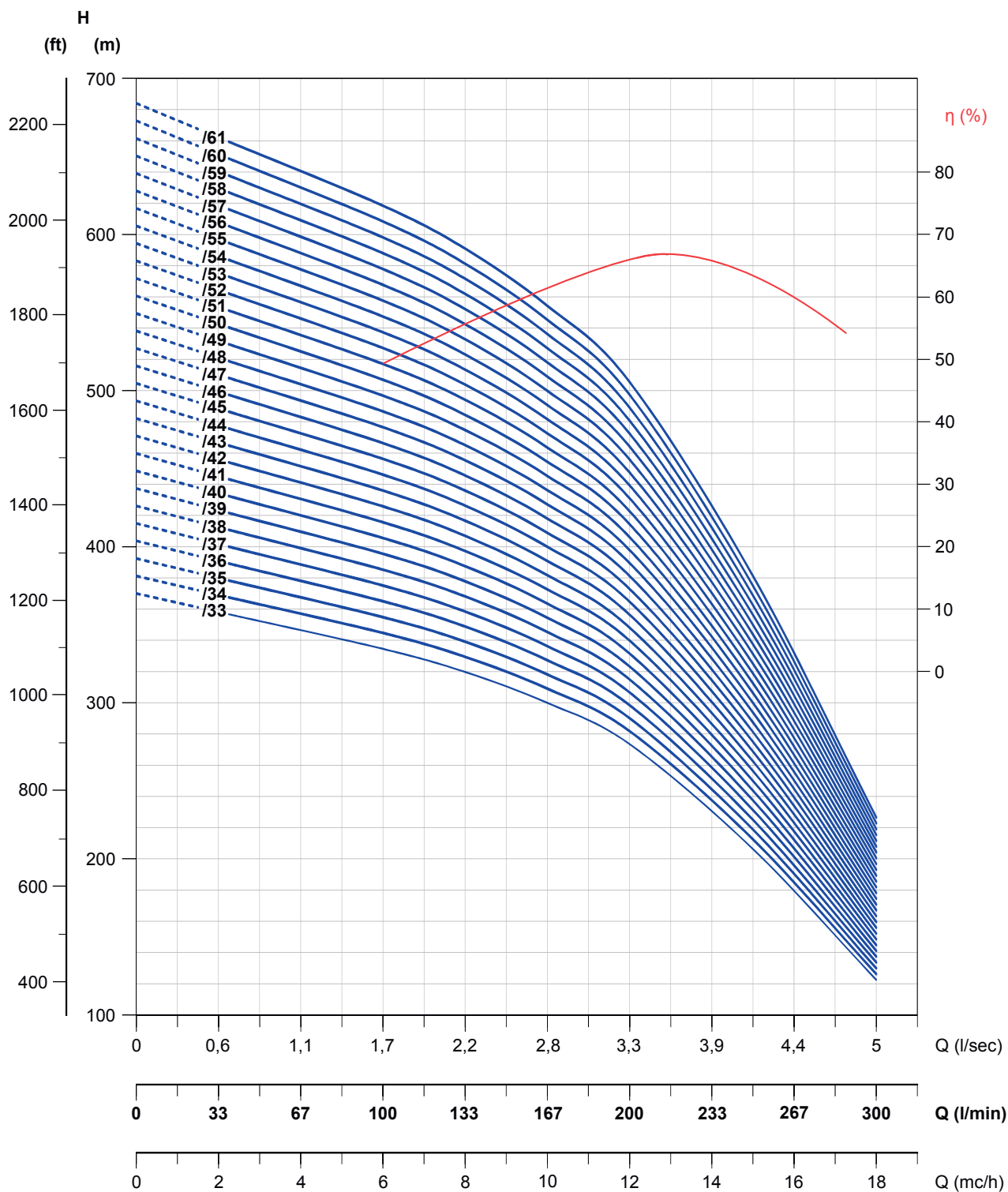
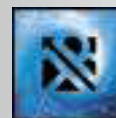

Tolleranze secondo EN ISO 9906 app.A Gr.2 - Tolerances according to EN ISO 9906 anx.A Gr.2 - Tolérances conformes EN ISO 9906 ann.A Gr.2
 Rispetta il Reg. UE n° 547/2012 con MEI = 0.40 - Comply with Reg. UE n° 547/2012 with MEI = 0.40 - Conforme Reg. UE n°547/2012 avec MEI = 0.40

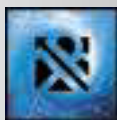

FB6RX20

DATI DELLE PRESTAZIONI
PERFORMANCES' DATA
DONNÉES DES PERFORMANCES

Tipo Type Type	Motore Motors 2900 g/m Moteurs		Q = Portata - Capacity - Débit											
			Cv Hp	Kw	l/sec	0	2,2	2,8	3,3	4,2	5,0	5,8	6,7	7,5
					l/min	0	133	167	200	250	300	350	400	450
					mc/h	0	8	10	12	15	18	21	24	27
FB6RX20/3 + 4B3	3	2,2	35	33	32	31	29	26	22	16	10			
FB6RX20/4 + 4B4	4	3	47	44	43	41	38	34	29	22	14			
FB6RX20/5 + 6F5	5,5	4	59	55	53	52	48	43	36	27	17			
FB6RX20/6 + 6F5	5,5	4	70	66	64	62	58	52	43	33	21			
FB6RX20/7 + 6F7	7,5	5,5	82	78	75	72	67	60	50	38	24			
FB6RX20/8 + 6F7	7,5	5,5	93	89	85	83	77	69	58	44	27			
FB6RX20/9 + 6F7	7,5	5,5	105	100	96	93	86	77	65	49	31			
FB6RX20/10 + 6F10	10	7,5	117	111	107	103	96	86	72	55	34			
FB6RX20/11 + 6F10	10	7,5	128	122	117	114	106	95	79	60	38			
FB6RX20/12 + 6F10	10	7,5	140	133	128	124	115	103	86	66	41			
FB6RX20/13 + 6F12	12,5	9,2	152	144	139	134	125	112	94	71	45			
FB6RX20/14 + 6F12	12,5	9,2	163	155	149	145	134	120	101	77	48			
FB6RX20/15 + 6F12	12,5	9,2	175	166	160	155	144	129	108	82	51			
FB6RX20/16 + 6F15	15	11	187	177	171	165	154	138	115	88	55			
FB6RX20/17 + 6F15	15	11	198	188	181	176	163	146	122	93	58			
FB6RX20/18 + 6F15	15	11	210	199	192	186	173	155	130	99	62			
FB6RX20/19 + 6F17	17,5	13	222	210	203	196	182	163	137	104	65			
FB6RX20/20 + 6F17	17,5	13	233	221	213	207	192	172	144	110	68			
FB6RX20/21 + 6F17	17,5	13	245	232	224	217	202	181	151	115	72			
FB6RX20/22 + 6F20	20	15	257	244	235	227	211	189	158	121	75			
FB6RX20/23 + 6F20	20	15	268	255	245	238	221	198	166	126	79			
FB6RX20/24 + 6F20	20	15	280	266	256	248	230	206	173	132	82			
FB6RX20/25 + 6F25	25	18,5	292	277	267	258	240	215	180	137	86			
FB6RX20/26 + 6F25	25	18,5	303	288	277	269	250	224	187	143	89			
FB6RX20/27 + 6F25	25	18,5	315	299	288	279	259	232	194	148	92			
FB6RX20/28 + 6F25	25	18,5	327	310	299	289	269	241	202	154	96			
FB6RX20/29 + 6F25	25	18,5	338	321	309	300	278	249	209	159	99			
FB6RX20/30 + 6F25	25	18,5	350	332	320	310	288	258	216	165	103			
FB6RX20/31 + 6F30	30	22	362	343	331	320	298	267	223	170	106			



Dimensioni e pesi

Overall dimensions and weights - Dimensions d'encombrement et poids

Tipo Type Type	Cv Hp	Kw	A (mm)	B (mm)	C (mm)	D (mm)	ø max (mm)	DN	Peso - Weight - Poids		
									A (kg)	B (kg)	C (kg)
									FB6RX20/3 + 4B3	3	2,2
FB6RX20/4 + 4B4	4	3	1038	533	505	145	145	G 2"1/2	24	11	13
FB6RX20/5 + 6F5	5,5	4	1137	570	567				56	12	44
FB6RX20/6 + 6F5	5,5	4	1062	495	567				57	13	44
FB6RX20/7 + 6F7	7,5	5,5	1160	533	627				60	14	46
FB6RX20/8 + 6F7	7,5	5,5	1197	570	627				61	15	46
FB6RX20/9 + 6F7	7,5	5,5	1235	608	627				62	16	46
FB6RX20/10 + 6F10	10	7,5	1312	645	667				67	17	50
FB6RX20/11 + 6F10	10	7,5	1350	683	667				68	18	50
FB6RX20/12 + 6F10	10	7,5	1387	720	667				68	18	50
FB6RX20/13 + 6F12	12,5	9,2	1455	758	697				73	19	54
FB6RX20/14 + 6F12	12,5	9,2	1492	795	697				74	20	54
FB6RX20/15 + 6F12	12,5	9,2	1530	833	697				75	21	54
FB6RX20/16 + 6F15	15	11	1637	870	767				83	22	61
FB6RX20/17 + 6F15	15	11	1675	908	767				84	23	61
FB6RX20/18 + 6F15	15	11	1712	945	767				85	24	61
FB6RX20/19 + 6F17	17,5	13	1750	983	767				87	25	62
FB6RX20/20 + 6F17	17,5	13	869	102	767				88	26	62
FB6RX20/21 + 6F17	17,5	13	1825	1058	767				89	27	62
FB6RX20/22 + 6F20	20	15	1922	1095	827				96	28	68
FB6RX20/23 + 6F20	20	15	1960	1133	827				97	29	68
FB6RX20/24 + 6F20	20	15	1997	1170	827				98	30	68
FB6RX20/25 + 6F25	25	18,5	2105	1208	897				106	31	75
FB6RX20/26 + 6F25	25	18,5	2142	1245	897				106	31	75
FB6RX20/27 + 6F25	25	18,5	2180	1283	897				107	32	75
FB6RX20/28 + 6F25	25	18,5	2217	1320	897				108	33	75
FB6RX20/29 + 6F25	25	18,5	2254	1357	897				109	34	75
FB6RX20/30 + 6F25	25	18,5	2292	1395	897				110	35	75
FB6RX20/31 + 6F30	30	22	2399	1432	967				118	36	82

Tolleranze secondo EN ISO 9906 app.A Gr.2 - Tolerances according to EN ISO 9906 anx.A Gr.2 - Tolérances conformes EN ISO 9906 ann.A Gr.2
Rispetta il Reg. UE n° 547/2012 con MEI = 0.40 - Comply with Reg. UE n° 547/2012 with MEI = 0.40 - Conforme Reg. UE n°547/2012 avec MEI=0.40

CURVE DELLE PRESTAZIONI

PERFORMANCES' CURVES

COURBES DES PERFORMANCES

FB6RX20

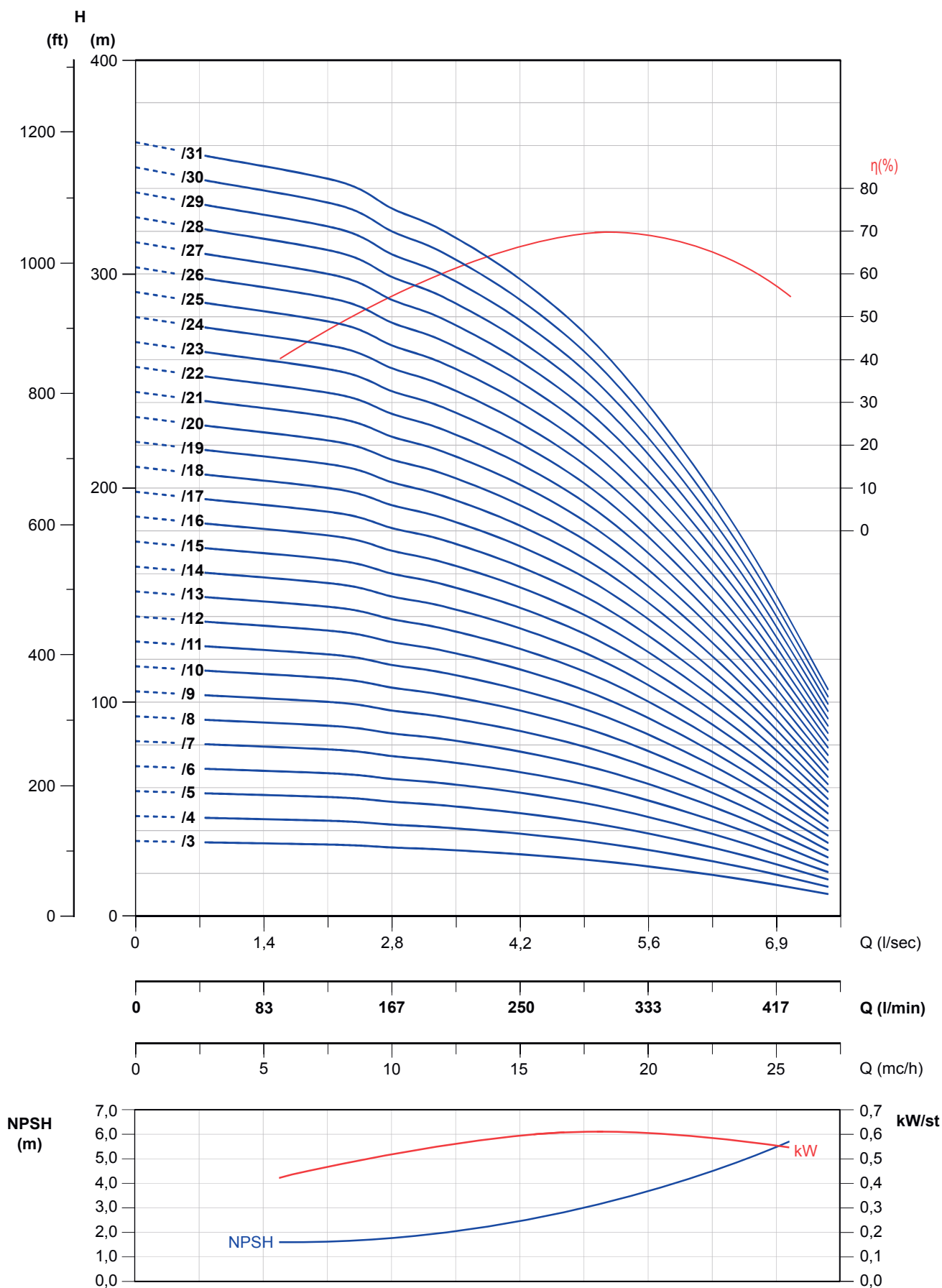
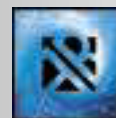

Tolleranze secondo EN ISO 9906 app.A Gr.2 - Tolerances according to EN ISO 9906 anx.A Gr.2 - Tolérances conformes EN ISO 9906 ann.A Gr.2
 Rispetta il Reg. UE n° 547/2012 con MEI = 0.40 - Comply with Reg. UE n° 547/2012 with MEI = 0.40 - Conforme Reg. UE n°547/2012 avec MEI=0.40

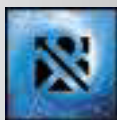

FB6RX20

DATI DELLE PRESTAZIONI
PERFORMANCES' DATA
DONNÉES DES PERFORMANCES

Tipo Type Type	Motore Motors 2900 g/m Moteurs		Q = Portata - Capacity - Débit									
	Cv Hp	Kw	l/sec	0	2,2	2,8	3,3	4,2	5,0	5,8	6,7	7,5
			l/min	0	133	167	200	250	300	350	400	450
			mc/h	0	8	10	12	15	18	21	24	27
FB6RX20/32 + 6F30	30	22	H(m)	373	354	341	331	307	275	230	176	109
FB6RX20/33 + 6F30	30	22		385	365	352	341	317	284	238	181	113
FB6RX20/34 + 6F30	30	22		397	376	363	351	326	292	245	187	116
FB6RX20/35 + 6F30	30	22		408	387	373	362	336	301	252	192	120
FB6RX20/36 + 6F30	30	22		420	398	384	372	346	310	259	198	123
FB6RX20/37 + 6F35	35	26		432	410	395	382	355	318	266	203	127
FB6RX20/38 + 6F35	35	26		443	421	405	393	365	327	274	209	130
FB6RX20/39 + 6F35	35	26		455	432	416	403	374	335	281	214	133
FB6RX20/40 + 6F35	35	26		467	443	427	413	384	344	288	220	137
FB6RX20/41 + 6F35	35	26		478	454	437	424	394	353	295	225	140
FB6RX20/42 + 6F35	35	26		490	465	448	434	403	361	302	230	144
FB6RX20/43 + 6F40*	40	30		502	476	459	444	413	370	310	236	147
FB6RX20/44 + 6F40*	40	30		513	487	469	455	422	378	317	241	151
FB6RX20/45 + 6F40*	40	30		525	498	480	465	432	387	324	247	154
FB6RX20/46 + 6F40*	40	30		537	509	491	475	442	396	331	252	157
FB6RX20/47 + 6F40*	40	30		548	520	501	486	451	404	338	258	161
FB6RX20/48 + 6F40*	40	30		560	531	512	496	461	413	346	263	164
FB6RX20/49 + 6F40*	40	30		572	542	523	506	470	421	353	269	168
FB6RX20/50 + 6F50*	50	37		583	553	533	517	480	430	360	274	171
FB6RX20/51 + 6F50*	50	37		595	564	544	527	490	439	367	280	174
FB6RX20/52 + 6F50*	50	37		607	576	555	537	499	447	374	285	178
FB6RX20/53 + 6F50*	50	37		618	587	565	548	509	456	382	291	181
FB6RX20/54 + 6F50*	50	37		630	598	576	558	518	464	389	296	185
FB6RX20/55 + 6F50*	50	37		642	609	587	568	528	473	396	302	188
FB6RX20/56 + 6F50*	50	37		653	620	597	579	538	482	403	307	192
FB6RX20/57 + 6F50*	50	37		665	631	608	589	547	490	410	313	195
FB6RX20/58 + 6F50*	50	37		677	642	619	599	557	499	418	318	198
FB6RX20/59 + 6F50*	50	37		688	653	629	610	566	507	425	324	202
FB6RX20/60 + 6F50*	50	37		700	664	640	620	576	516	432	329	205



Dimensioni e pesi

Overall dimensions and weights - Dimensions d'encombrement et poids

Tipo Type Type	Cv Hp	Kw	A (mm)	B (mm)	C (mm)	D (mm)	ø max (mm)	DN	Peso - Weight - Poids		
									A (kg)	B (kg)	C (kg)
FB6RX20/32 + 6F30	30	22	2510	1470	967	145	145	G 2"1/2	123	37	82
FB6RX20/33 + 6F30	30	22	2547	1507	967				125	38	82
FB6RX20/34 + 6F30	30	22	2585	1545	967				197	39	82
FB6RX20/35 + 6F30	30	22	2549	1582	967				122	40	82
FB6RX20/36 + 6F30	30	22	2587	1620	967				123	41	82
FB6RX20/37 + 6F35	35	26	2684	1657	1027				131	42	89
FB6RX20/38 + 6F35	35	26	2722	1695	1027				132	43	89
FB6RX20/39 + 6F35	35	26	2759	1732	1027				133	44	89
FB6RX20/40 + 6F35	35	26	2797	1770	1027				133	44	89
FB6RX20/41 + 6F35	35	26	2834	1807	1027				134	45	89
FB6RX20/42 + 6F35	35	26	2872	1845	1027				135	46	89
FB6RX20/43 + 6F40*	40	30	3049	1882	1167				150	47	103
FB6RX20/44 + 6F40*	40	30	3087	1920	1167				151	48	103
FB6RX20/45 + 6F40*	40	30	3124	1957	1167				152	49	103
FB6RX20/46 + 6F40*	40	30	3161	1994	1167				153	50	103
FB6RX20/47 + 6F40*	40	30	3199	2032	1167				154	51	103
FB6RX20/48 + 6F40*	40	30	3236	2069	1167				156	53	103
FB6RX20/49 + 6F40*	40	30	3274	2107	1167				156	53	103
FB6RX20/50 + 6F50*	50	37	3441	2144	1297				170	54	116
FB6RX20/51 + 6F50*	50	37	3479	2182	1297				171	55	116
FB6RX20/52 + 6F50*	50	37	3516	2219	1297				172	56	116
FB6RX20/53 + 6F50*	50	37	3553	2256	1297				173	57	116
FB6RX20/54 + 6F50*	50	37	3591	2294	1297				174	58	116
FB6RX20/55 + 6F50*	50	37	3629	2332	1297				175	59	116
FB6RX20/56 + 6F50*	50	37	3666	2369	1297				176	60	116
FB6RX20/57 + 6F50*	50	37	3704	2407	1297				177	61	116
FB6RX20/58 + 6F50*	50	37	1541	244	1297				177	61	116
FB6RX20/59 + 6F50*	50	37	3779	2482	1297				179	63	116
FB6RX20/60 + 6F50*	50	37	3816	2519	1297				179	63	116

* Non consigliata per montaggio in posizione orizzontale
* This electropump isn't recommended for horizontal assemblage
* Cette électropompe n'est pas recommandée pour le montage en position horizontale

Tolleranze secondo EN ISO 9906 app.A Gr.2 - Tolerances according to EN ISO 9906 anx.A Gr.2 - Tolérances conformes EN ISO 9906 ann.A Gr.2
Rispetta il Reg. UE n° 547/2012 con MEI = 0.40 - Comply with Reg. UE n° 547/2012 with MEI = 0.40 - Conforme Reg. UE n°547/2012 avec MEI =0.40

CURVE DELLE PRESTAZIONI

PERFORMANCES' CURVES

COURBES DES PERFORMANCES

FB6RX20

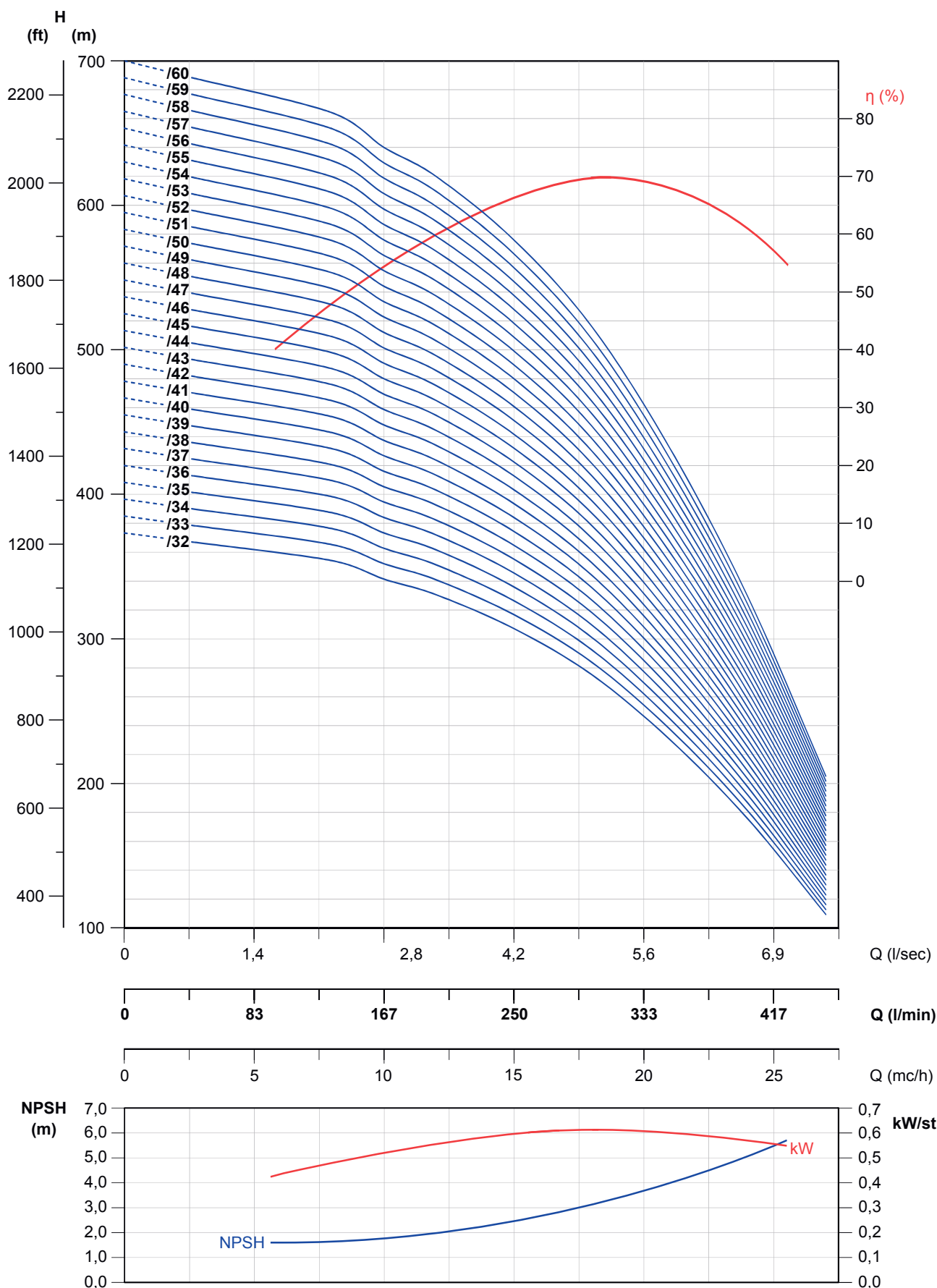
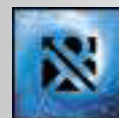

Tolleranze secondo EN ISO 9906 app.A Gr.2 - Tolerances according to EN ISO 9906 anx.A Gr.2 - Tolérances conformes EN ISO 9906 ann.A Gr.2
 Rispetta il Reg. UE n° 547/2012 con MEI = 0.40 - Comply with Reg. UE n° 547/2012 with MEI = 0.40 - Conforme Reg. UE n°547/2012 avec MEI=0.40

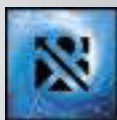

FB6RX28

DATI DELLE PRESTAZIONI
PERFORMANCES' DATA
DONNÉES DES PERFORMANCES

Tipo Type Type	Motore Motors 2900 g/m Moteurs		Q = Portata - Capacity - Débit									
	Cv Hp	Kw	l/sec	0	3,3	4,4	5,6	6,7	7,8	8,9	10,0	11,1
			l/min	0	200	267	333	400	467	533	600	667
			mc/h	0	12	16	20	24	28	32	36	40
FB6RX28/2 + 4B3	3	2,2	H(m)	24	22	22	20	19	17	14	11	8
FB6RX28/3 + 4B4	4	3		36	34	33	31	29	25	21	17	12
FB6RX28/4 + 6F5	5,5	4		48	45	44	41	38	33	28	23	16
FB6RX28/5 + 6F7	7,5	5,5		61	56	55	51	48	42	35	29	20
FB6RX28/6 + 6F10	10	7,5		73	67	66	62	57	50	42	34	24
FB6RX28/7 + 6F10	10	7,5		85	79	77	72	67	59	49	40	28
FB6RX28/8 + 6F12	12,5	9,2		97	90	88	82	76	67	56	46	32
FB6RX28/9 + 6F12	12,5	9,2		109	101	99	92	86	75	63	51	36
FB6RX28/10 + 6F15	15	11		121	112	109	102	95	84	70	57	40
FB6RX28/11 + 6F15	15	11		133	124	120	113	105	92	77	63	44
FB6RX28/12 + 6F17	17,5	13		145	135	131	123	114	100	84	68	48
FB6RX28/13 + 6F17	17,5	13		157	146	142	133	124	109	91	74	52
FB6RX28/14 + 6F20	20	15		169	157	153	143	133	117	98	80	56
FB6RX28/15 + 6F20	20	15		182	168	164	154	143	125	105	86	60
FB6RX28/16 + 6F25	25	18,5		194	180	175	164	152	134	112	91	64
FB6RX28/17 + 6F25	25	18,5		206	191	186	174	162	142	119	97	68
FB6RX28/18 + 6F25	25	18,5		218	202	197	184	171	150	126	103	72
FB6RX28/19 + 6F25	25	18,5		230	213	208	195	180	159	133	108	76
FB6RX28/20 + 6F30	30	22		242	225	219	205	190	167	140	114	80
FB6RX28/21 + 6F30	30	22		254	236	230	215	200	176	147	120	84
FB6RX28/22 + 6F30	30	22		266	247	241	225	209	184	154	125	88
FB6RX28/23 + 6F30	30	22		278	258	252	236	219	192	161	131	92



Dimensioni e pesi

Overall dimensions and weights - Dimensions d'encombrement et poids

Tipo Type Type	Cv Hp	Kw	A (mm)	B (mm)	C (mm)	D (mm)	ø max (mm)	DN	Peso - Weight - Poids		
									A (kg)	B (kg)	C (kg)
									FB6RX28/2 + 4B3	3	2,2
FB6RX28/3 + 4B4	4	3	963	459	505			24	11	13	
FB6RX28/4 + 6F5	5,5	4	1102	505	597			56	12	44	
FB6RX28/5 + 6F7	7,5	5,5	1179	552	627			60	14	46	
FB6RX28/6 + 6F10	10	7,5	1265	598	667			65	15	50	
FB6RX28/7 + 6F10	10	7,5	1312	645	667			66	16	50	
FB6RX28/8 + 6F12	12,5	9,2	1388	691	697			71	17	54	
FB6RX28/9 + 6F12	12,5	9,2	1435	738	697			72	18	54	
FB6RX28/10 + 6F15	15	11	1551	784	767			80	19	61	
FB6RX28/11 + 6F15	15	11	1598	831	767			81	20	61	
FB6RX28/12 + 6F17	17,5	13	1644	877	767			83	21	62	
FB6RX28/13 + 6F17	17,5	13	1691	924	767	145	145	84	22	62	
FB6RX28/14 + 6F20	20	15	1797	970	827			91	23	68	
FB6RX28/15 + 6F20	20	15	1844	1017	827			93	25	68	
FB6RX28/16 + 6F25	25	18,5	1960	1063	897			101	26	75	
FB6RX28/17 + 6F25	25	18,5	2007	1110	897			102	27	75	
FB6RX28/18 + 6F25	25	18,5	2053	1156	897			103	28	75	
FB6RX28/19 + 6F25	25	18,5	2100	1203	897			104	29	75	
FB6RX28/20 + 6F30	30	22	2216	1249	967			112	30	82	
FB6RX28/21 + 6F30	30	22	2263	1296	967			113	31	82	
FB6RX28/22 + 6F30	30	22	2309	1342	967			114	32	82	
FB6RX28/23 + 6F30	30	22	2356	1389	967			115	33	82	

CURVE DELLE PRESTAZIONI

PERFORMANCES' CURVES

COURBES DES PERFORMANCES

FB6RX28

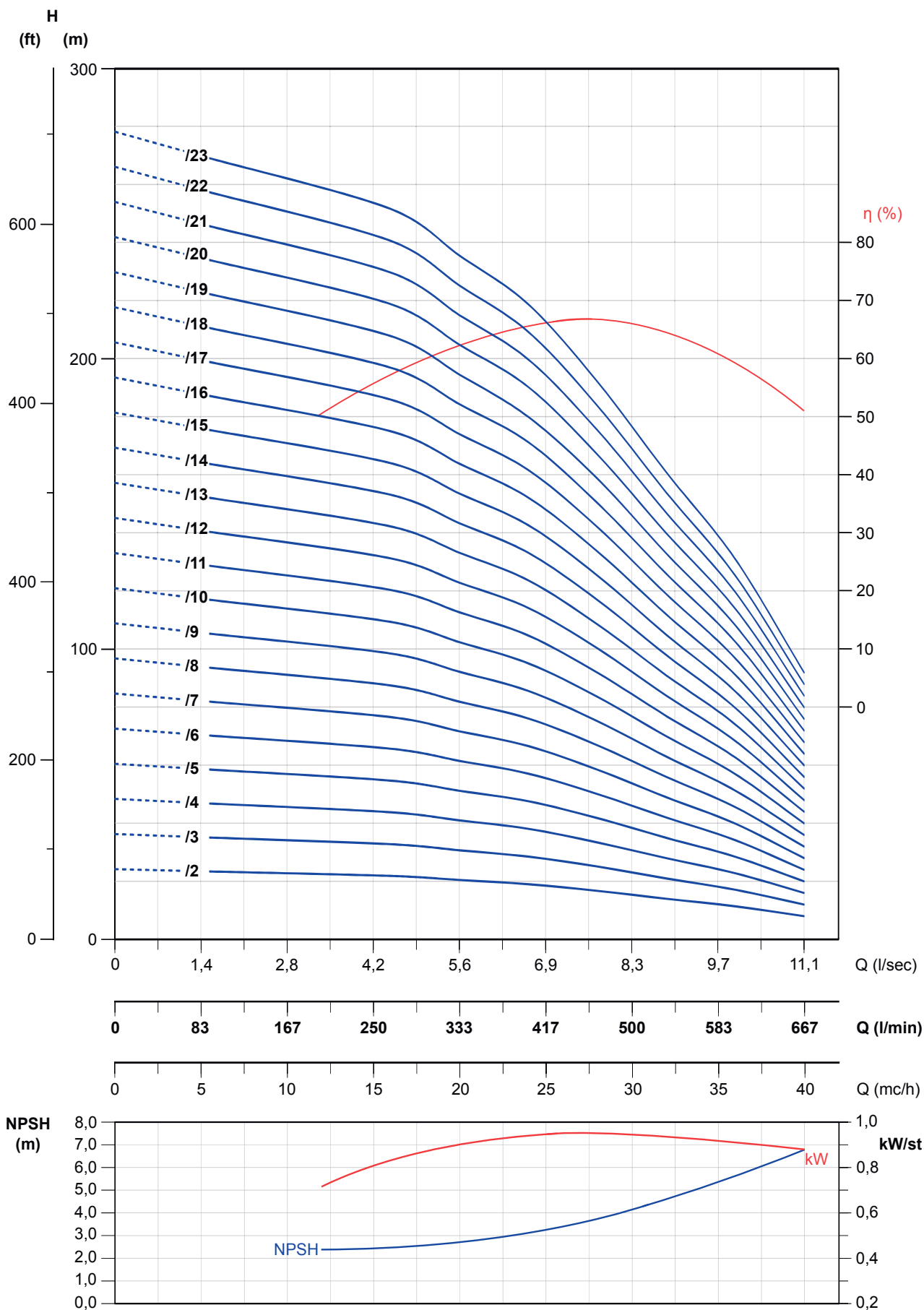
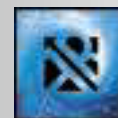

Tolleranze secondo EN ISO 9906 app.A Gr.2 - Tolerances according to EN ISO 9906 anx.A Gr.2 - Tolérances conformes EN ISO 9906 ann.A Gr.2

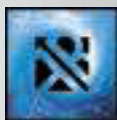

FB6RX28

DATI DELLE PRESTAZIONI
PERFORMANCES' DATA
DONNÉES DES PERFORMANCES

Tipo Type Type	Motore Motors 2900 g/m Moteurs		Q = Portata - Capacity - Débit									
	Cv Hp	Kw	l/sec	0	3,3	4,4	5,6	6,7	7,8	8,9	10,0	11,1
			l/min	0	200	267	333	400	467	533	600	667
			mc/h	0	12	16	20	24	28	32	36	40
FB6RX28/24 + 6F35	35	26	H(m)	290	270	263	246	228	200	168	137	96
FB6RX28/25 + 6F35	35	26		303	281	274	256	238	209	175	143	100
FB6RX28/26 + 6F35	35	26		315	292	285	266	247	217	182	148	104
FB6RX28/27 + 6F35	35	26		327	303	296	277	257	226	189	154	108
FB6RX28/28 + 6F40*	40	30		339	315	306	287	266	234	196	160	112
FB6RX28/29 + 6F40*	40	30		351	326	317	297	276	242	203	165	116
FB6RX28/30 + 6F40*	40	30		363	337	328	307	285	251	210	171	120
FB6RX28/31 + 6F40*	40	30		375	348	339	318	295	259	217	177	124
FB6RX28/32 + 6F50*	50	37		387	359	350	328	305	267	224	182	128
FB6RX28/33 + 6F50*	50	37		399	371	361	338	314	276	231	188	132
FB6RX28/34 + 6F50*	50	37		411	382	372	348	324	284	238	194	136
FB6RX28/35 + 6F50*	50	37		424	393	383	359	333	293	245	200	140
FB6RX28/36 + 6F50*	50	37		436	404	394	369	343	301	252	205	144
FB6RX28/37 + 6F50*	50	37		448	416	405	379	352	309	259	211	148
FB6RX28/38 + 6F50*	50	37		460	427	416	389	362	318	266	217	152
FB6RX28/39 + 6F60*	60	45		472	438	427	400	371	326	273	222	156
FB6RX28/40 + 6F60*	60	45		484	449	438	410	381	334	280	228	160
FB6RX28/41 + 6F60*	60	45		496	461	449	420	390	343	287	234	164
FB6RX28/42 + 6F60*	60	45		508	472	460	430	400	351	294	239	168
FB6RX28/43 + 6F60*	60	45		520	483	471	440	409	359	301	245	172
FB6RX28/44 + 6F60*	60	45		532	494	482	451	419	368	308	251	176
FB6RX28/45 + 6F60*	60	45		545	505	492	461	428	376	315	257	180
FB6RX28/46 + 6F60*	60	45		557	517	503	471	438	384	322	262	184



Dimensioni e pesi

Overall dimensions and weights - Dimensions d'encombrement et poids

Tipo Type Type	Cv Hp	Kw	A (mm)	B (mm)	C (mm)	D (mm)	ø max (mm)	DN	Peso - Weight - Poids		
									A (kg)	B (kg)	C (kg)
FB6RX28/24 + 6F35	35	26	2462	1435	1027	145	145	G 3"	123	34	89
FB6RX28/25 + 6F35	35	26	2508	1481	1027				124	35	89
FB6RX28/26 + 6F35	35	26	2555	1528	1027				126	37	89
FB6RX28/27 + 6F35	35	26	2601	1574	1027				127	38	89
FB6RX28/28 + 6F40*	40	30	2788	1621	1167				142	39	103
FB6RX28/29 + 6F40*	40	30	2834	1667	1167				143	40	103
FB6RX28/30 + 6F40*	40	30	2881	1714	1167				144	41	103
FB6RX28/31 + 6F40*	40	30	2927	1760	1167				145	42	103
FB6RX28/32 + 6F50*	50	37	3104	1807	1297				159	43	116
FB6RX28/33 + 6F50*	50	37	3150	1853	1297				160	44	116
FB6RX28/34 + 6F50*	50	37	3197	1900	1297				161	45	116
FB6RX28/35 + 6F50*	50	37	3243	1946	1297				162	46	116
FB6RX28/36 + 6F50*	50	37	3290	1993	1297				163	47	116
FB6RX28/37 + 6F50*	50	37	3336	2039	1297				165	49	116
FB6RX28/38 + 6F50*	50	37	3383	2086	1297				166	50	116
FB6RX28/39 + 6F60*	60	45	3459	2132	1327				172	51	121
FB6RX28/40 + 6F60*	60	45	3505	2178	1327				173	52	121
FB6RX28/41 + 6F60*	60	45	3552	2225	1327				174	53	121
FB6RX28/42 + 6F60*	60	45	3598	2271	1327				175	54	121
FB6RX28/43 + 6F60*	60	45	3645	2318	1327				176	55	121
FB6RX28/44 + 6F60*	60	45	3691	2364	1327				177	56	121
FB6RX28/45 + 6F60*	60	45	3738	2411	1327				178	57	121
FB6RX28/46 + 6F60*	60	45	3784	2457	1327				179	58	121

* Non consigliata per montaggio in posizione orizzontale
* This electropump isn't recommended for horizontal assemblage
* Cette électropompe n'est pas recommandée pour le montage en position horizontale

CURVE DELLE PRESTAZIONI

PERFORMANCES' CURVES

COURBES DES PERFORMANCES

FB6RX28

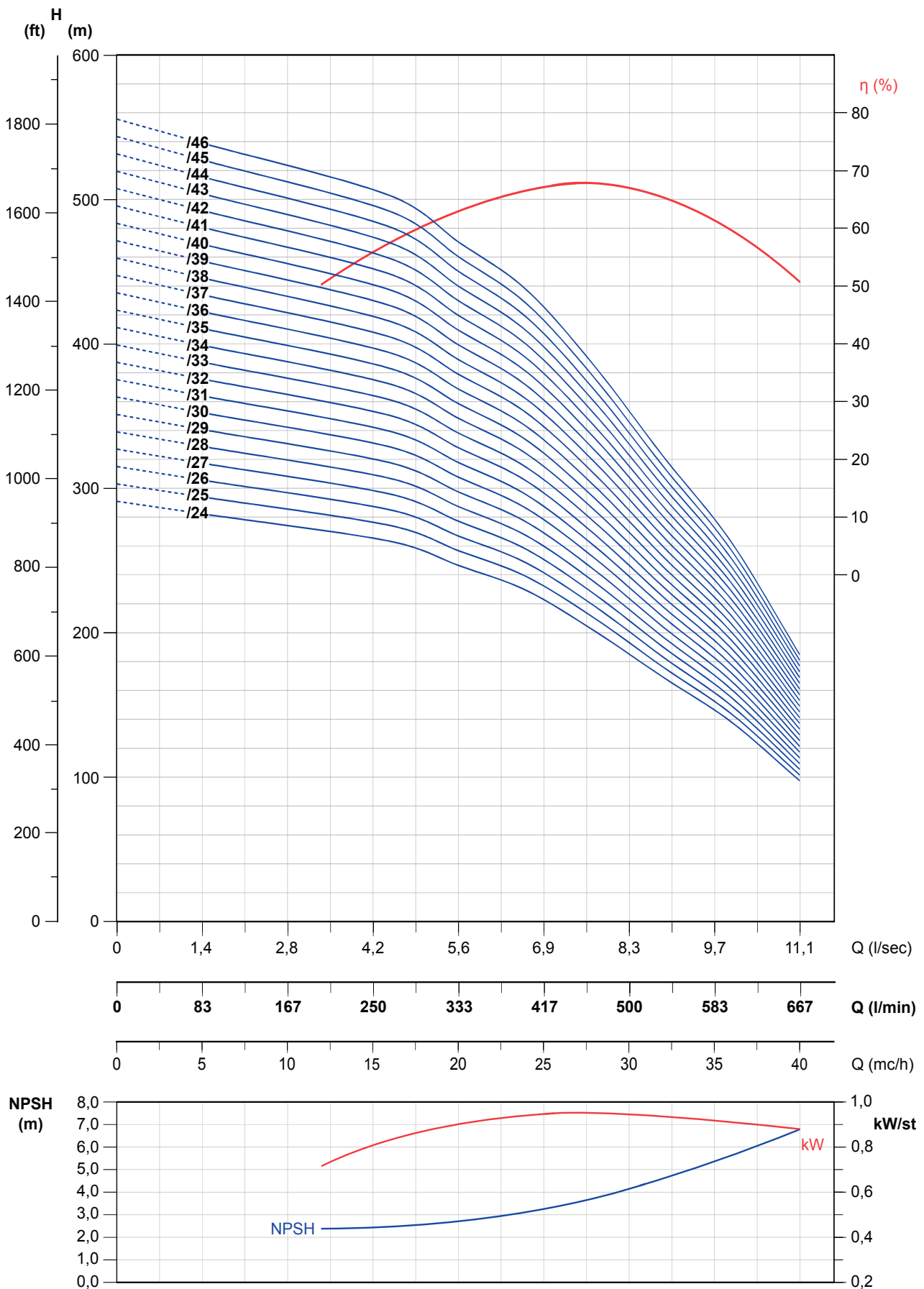
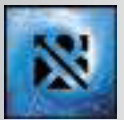

Tolleranze secondo EN ISO 9906 app.A Gr.2 - Tolerances according to EN ISO 9906 anx.A Gr.2 - Tolérances conformes EN ISO 9906 ann.A Gr.2

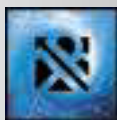

ELETTROPOMPE SOMMERSE 6" SEMIASSIALI IN ACCIAIO INOX AISI 304, AISI 316 E AISI 904L

6" MIXED-FLOW STAINLESS STEEL AISI 304, AISI 316 AND AISI 904L ELECTROPUMPS

ÉLECTROPOMPES IMMERGÉES 6" SEMI-AXIALES EN ACIER INOXYDABLE AISI 304, AISI 316 ET AISI 904L



La struttura totalmente in acciaio inossidabile con camera esterna, garantisce l'allineamento permanente di tutti i componenti che assieme agli anelli di rasamento flottanti in PTFE, le bocche di guida in ceramica, i cuscinetti scanalati in gomma conferiscono al corpo pompa una maggiore resistenza nel tempo. La gamma è stata studiata per garantire un'elevata efficienza con la riduzione del consumo di energia e quindi dei costi.

APPLICAZIONI:

- irrigazione, approvvigionamento idrico, aumento pressione, ed antincendio
- acque potabili
- acque di mare
- acque salmastre
- acque termali e sulfuree
- desalinizzazione ed osmosi
- acque aggressive e corrosive
- vari settori dell'industria: alimentare, petrolchimica, siderurgica e navale
- applicazioni gravose: miniera

CONSTRUZIONE IN ACCIAIO INOX AISI 304:

- giranti in acciaio inox AISI 304 (W. Nr. 1.4301)
- corpo di stadio in acciaio inox AISI 304 (W. Nr. 1.4301)
- bocca di mandata in acciaio inox AISI 304 (W. Nr. 1.4301)
- valvola di ritegno in acciaio inox AISI 316 (W. Nr. 1.4401)
- albero in acciaio inox AISI 431 (W. Nr. 1.4057)
- proteggi cavo in acciaio inox AISI 316 (W. Nr. 1.4401)
- griglia d'aspirazione in acciaio inox AISI 316 (W. Nr. 1.4401)
- viteria in acciaio inox AISI 304 (W. Nr. 1.4301)

CONSTRUZIONE IN ACCIAIO INOX AISI 316:

- giranti in acciaio inox AISI 316 (W. Nr. 1.4401)
- corpo di stadio in acciaio inox AISI 316 (W. Nr. 1.4401)
- bocca di mandata in acciaio inox AISI 316 (W. Nr. 1.4401)
- valvola di ritegno in acciaio inox AISI 316 (W. Nr. 1.4401)
- albero in acciaio inox AISI 316 (W. Nr. 1.4401)
- proteggi cavo in acciaio inox AISI 316 (W. Nr. 1.4401)
- griglia d'aspirazione in acciaio inox AISI 316 (W. Nr. 1.4401)
- viteria in acciaio inox AISI 316 (W. Nr. 1.4401)

CONSTRUZIONE IN ACCIAIO INOX AISI 904L:

- giranti in acciaio inox AISI 904L (W. Nr. 1.4539)
- corpo di stadio in acciaio inox AISI 904L (W. Nr. 1.4539)
- bocca di mandata in acciaio inox AISI 904L (W. Nr. 1.4517)
- valvola di ritegno in acciaio inox AISI 2205 / AISI 904L (W. Nr. 1.4462 / 1.4460)
- albero in acciaio inox AISI 329 (W. Nr. 1.4460)
- proteggi cavo in acciaio inox AISI 904L (W. Nr. 1.4539)
- griglia d'aspirazione in acciaio inox AISI 904L (W. Nr. 1.4539)
- viteria in acciaio inox AISI 904L / AISI 329 (W. Nr. 1.4539 / W. Nr. 1.4460)

CARATTERISTICHE:

- portata massima: 1333 l/m
- prevalenza massima: 690 metri
- potenza massima: 55 kW
- diametro d'ingombro massimo: 192 mm (incluso il copri cavo)
- temperatura massima dell'acqua: 60°C (solo per corpo pompa, per il motore vedi catalogo motori)
- contenuto di sabbia massimo: 100 g/m³

OPTIONAL:

- Su richiesta si possono fornire:
- doppio proteggi cavo
 - attacco motore 4" NEMA
 - attacco motore 8" NEMA



The stainless steel construction with external sleeve, assure permanent alignment of all the components together with PTFE floating neck ring, ceramic guide journal sleeve and nitrile rubber fluted bearing to ensure the pump long-lasting performances.

This range is studied to ensure efficiency at the top of the market, thus reducing energy consumption and costs.

APPLICATIONS:

- irrigation, water supply system, pressure boosting, fire-fighting systems
- drinking water
- sea water
- brackish water
- thermal and sulphurous water
- desalinization and osmosis
- aggressive and corrosive waters
- different sectors of the industry: such as food, petrochemical, steel and shipbuilding
- hard applications: mine

STAINLESS STEEL AISI 304 CONSTRUCTION:

- stainless steel AISI 304 (W. Nr. 1.4301) impellers
- stainless steel AISI 304 (W. Nr. 1.4301) diffusers
- stainless steel AISI 304 (W. Nr. 1.4301) discharge head
- stainless steel AISI 316 (W. Nr. 1.4401) retaining valve
- stainless steel AISI 431 (W. Nr. 1.4057) shaft
- stainless steel AISI 316 (W. Nr. 1.4401) cable guard
- stainless steel AISI 316 (W. Nr. 1.4401) suction strainer
- stainless steel AISI 304 (W. Nr. 1.4301) bolts and screws

STAINLESS STEEL AISI 316 CONSTRUCTION:

- stainless steel AISI 316 (W. Nr. 1.4401) impellers
- stainless steel AISI 316 (W. Nr. 1.4401) diffusers
- stainless steel AISI 316 (W. Nr. 1.4401) discharge head
- stainless steel AISI 316 (W. Nr. 1.4401) retaining valve
- stainless steel AISI 316 (W. Nr. 1.4401) shaft
- stainless steel AISI 316 (W. Nr. 1.4401) cable guard
- stainless steel AISI 316 (W. Nr. 1.4401) suction strainer
- stainless steel AISI 316 (W. Nr. 1.4401) bolts and screws

STAINLESS STEEL AISI 904L CONSTRUCTION:

- stainless steel AISI 904L (W. Nr. 1.4539) impellers
- stainless steel AISI 904L (W. Nr. 1.4539) diffusers
- stainless steel AISI 904L (W. Nr. 1.4517) discharge head
- stainless steel AISI 2205 / AISI 904L (W. Nr. 1.4462 / 1.4460) retaining valve
- stainless steel AISI 329 (W. Nr. 1.4460) shaft
- stainless steel AISI 904L (W. Nr. 1.4539) cable guard
- stainless steel AISI 904L (W. Nr. 1.4539) suction strainer
- stainless steel AISI 904L / AISI 329 (W. Nr. 1.4539 / W. Nr. 1.4460) bolts and screws

FEATURES:

- maximum capacity: 1333 l/m
- maximum head: 690 meters
- maximum power: 55 Kw
- maximum encumbrance diameter: 192 mm (cable cover included)
- maximum water temperature: 60°C (only for the pump, for the motor see motors' catalogue)
- maximum sand content: 100 g/m³

OPTIONAL:

On demand pumps can be supplied with:

- double cable guard
- 4" NEMA coupling
- 8" NEMA coupling

ELETTROPOMPE SOMMERSE 6" SEMIASSIALI IN ACCIAIO INOX AISI 304, AISI 316 E AISI 904L

6" MIXED-FLOW STAINLESS STEEL AISI 304, AISI 316 AND AISI 904L ELECTROPUMPS

ÉLECTROPOMPES IMMERGÉES 6" SEMI-AXIALES EN ACIER INOXYDABLE AISI 304, AISI 316 ET AISI 904L



La structure en acier inoxydable avec la chemise externe, garantit l'alignement permanent de tous les composants et avec les bagues d'usure flottantes en PTFE, les douilles de guidage en céramique et les coussinets rainurés en caoutchouc confèrent à la pompe plus résistance dans les temps.

La gamme a été étudiée pour garantir haute efficacité en réduisant la consommation d'énergie et donc des coûts.

APPLICATIONS:

- irrigation, installation d'approvisionnement hydrique, surpression et anti incendie
- eau potable
- eau de mer
- eau saumâtre
- eau thermale e sulfureuse
- dessalement et osmose
- eau agressive et corrosives
- différents secteurs de l'industrie: alimentaire, pétrochimie, sidérurgique et navale
- applications dures: mine

CONSTRUCTION EN ACIER INOX AISI 304:

- roues en acier inoxydable AISI 304 (W. Nr. 1.4301)
- corps d'étage en acier inoxydable AISI 304 (W. Nr. 1.4301)
- orifice de refoulement en acier inoxydable AISI 304 (W. Nr. 1.4301)
- crépine de non-retour en acier inoxydable AISI 316 (W. Nr. 1.4401)
- arbre en acier inoxydable AISI 431 (W. Nr. 1.4057)
- couvre-câble en acier inoxydable AISI 316 (W. Nr. 1.4401)
- crépine d'aspiration en acier inoxydable AISI 316 (W. Nr. 1.4401)
- visserie en acier inoxydable AISI 304 (W. Nr. 1.4301)

CONSTRUCTION EN ACIER INOX AISI 316:

- roues en acier inoxydable AISI 316 (W. Nr. 1.4401)
- corps d'étage en acier inoxydable AISI 316 (W. Nr. 1.4401)
- orifice de refoulement en acier inoxydable AISI 316 (W. Nr. 1.4401)
- crépine de non-retour en acier inoxydable AISI 316 (W. Nr. 1.4401)
- arbre en acier inoxydable AISI 316 (W. Nr. 1.4401)
- couvre-câble en acier inoxydable AISI 316 (W. Nr. 1.4401)
- crépine d'aspiration en acier inoxydable AISI 316 (W. Nr. 1.4401)
- visserie en acier inoxydable AISI 316 (W. Nr. 1.4401)

CONSTRUCTION EN ACIER INOX AISI 904L:

- roues en acier inoxydable AISI 904L (W. Nr. 1.4539)
- corps d'étage en acier inoxydable AISI 904L (W. Nr. 1.4539)
- orifice de refoulement en acier inoxydable AISI 904L (W. Nr. 1.4517)
- crépine de non-retour en acier inoxydable AISI 2205 / AISI 904L (W. Nr. 1.4462 / 1.4460)
- arbre en acier inoxydable AISI 329 (W. Nr. 1.4460)
- couvre-câble en acier inoxydable AISI 904L (W. Nr. 1.4539)
- crépine d'aspiration en acier inoxydable AISI 904L (W. Nr. 1.4539)
- visserie en acier inoxydable AISI 904L / AISI 329 (W. Nr. 1.4539 / W. Nr. 1.4460)

CARACTÉRISTIQUES:

- débit maximum: 1333 l/m
- hauteur maximale: 690 mètres
- puissance maximale: 55 Kw
- diamètre d'encombrement maximum: 192 mm (inclus le couvre-câble)
- température maximale de l'eau: 60°C (pour la pompe, pour le moteur voir le catalogue des moteurs)
- quantité maximale de sable: 100 g/m³

OPTIONAL:

- Sur demande on peut fournir:
- double couvre-câble
- accouplement moteur 4" NEMA
- accouplement moteur 8" NEMA



NEW

AISI 304
AISI 316
AISI 904L



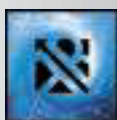

ACCOPIAMENTO MOTORE 4"

4" MOTOR COUPLINGS
ACCOUPEMENTS MOTEUR 4"

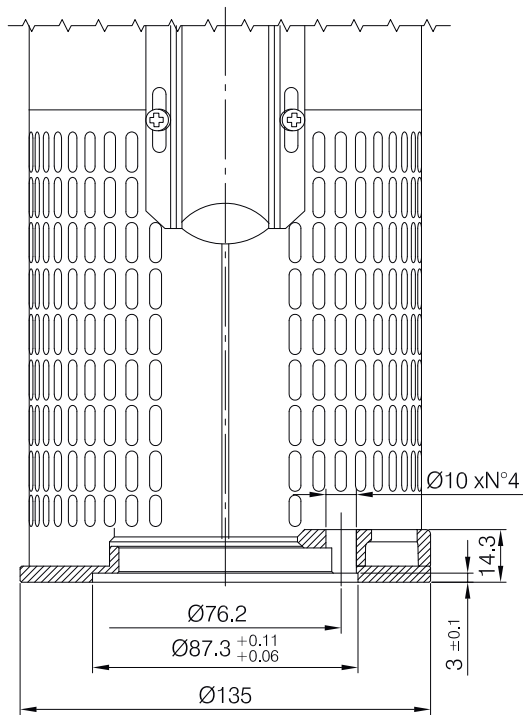

ACCOPIAMENTO MOTORE 6"

6" MOTOR COUPLINGS
ACCOUPEMENTS MOTEUR 6"

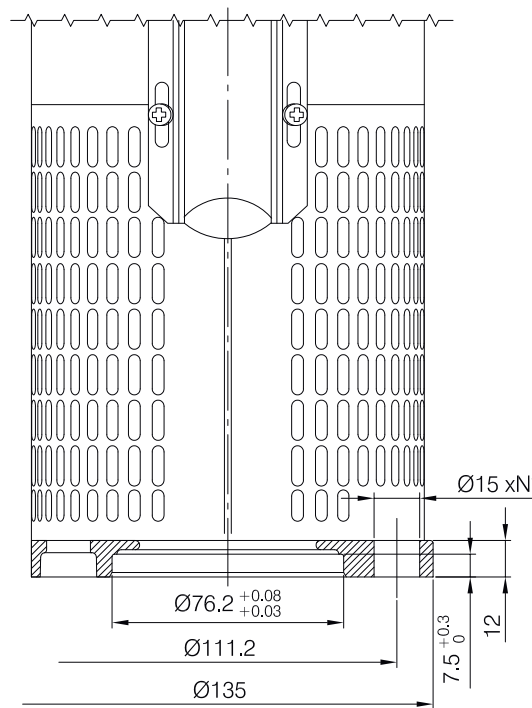

ACCOPIAMENTO MOTORE 8"

8" MOTOR COUPLINGS
ACCOUPEMENTS MOTEUR 8"

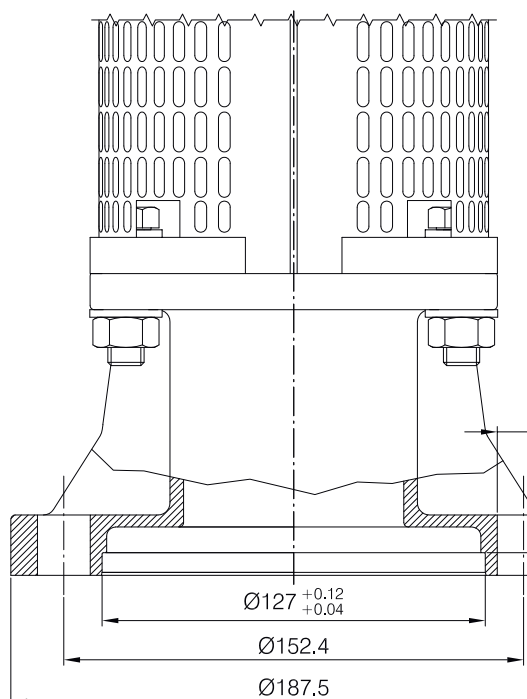

SPACCATO 6"

6" CUTAWAY

COUPE 6"

FB6SX

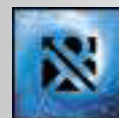

N°	Versione Version Version	AISI 304	AISI 316	AISI 904L
N°	Descrizione Description Description	Materiale Material Matériel	Materiale Material Matériel	Materiale Material Matériel
1	Corpo di mandata Discharge head Refoulement	AISI 304	AISI 316	AISI 904L
2	Valvola Valve Soupape	AISI 316	AISI 316	AISI 2205/904L
3	Anello tenuta OR O.R. ring Bague O.R.	NBR	NBR	NBR
4	Viti e dadi esterni Outer case locking nuts Vis et écrous externes	AISI 304	AISI 316	AISI 2205/904L
5	Supporto Valvola Valve support Support de soupape	AISI 316	AISI 316	AISI 2205
6	Anello seeger Circlip Segment d'arrête	AISI 316	AISI 316	AISI 904L
7	Camicia Sleeve Chemise	AISI 304	AISI 316	AISI 2205
8	Griglia di aspirazione Suction strainer Crépine d'aspiration	AISI 316	AISI 316	AISI 904L
9	Copricavo e viti Cable guard Protège cable	AISI 316	AISI 316	AISI 904L
10	Distanziale iniziale Initial spacer Entrotoise	AISI 304	AISI 316	AISI 904L
11	Flangia e bulloni Flange and screws Flange et boulon	AISI 304	AISI 316	AISI 904L
12	Supporto di aspirazione Suction support Support d'Aspiration	AISI 304	AISI 316	AISI 904L
13	Albero pompa Pump shaft Arbre pompe	AISI 431	AISI 316/329	AISI 329
14	Giunto Joint Joint	AISI 431/329	AISI 316/329	AISI 904L/329
15	Disco reggispinta sup. Upper thrust washer Butée supérieure	AISI 316	AISI 316	AISI 329
16	Boccola guida sup. Upper guide bush Cousinnet de guidage supérieure	AISI 329	AISI 316	AISI 329
17	Vite e rondella Screw and washer Vis et rondelle	AISI 316	AISI 316	AISI 904L/329
18	Anello reggispinta Thrust ring Bague de butée	PTFE + grafite PTFE + graphite PTFE + graphite	PTFE + grafite PTFE + graphite PTFE + graphite	PTFE + grafite PTFE + graphite PTFE + graphite
19	Diffusore Diffuser Diffuseur	AISI 304	AISI 316	AISI 904L
20	Bussola intermedia Intermediate bush Douille intermédiaire	NBR	NBR	NBR
21	Anello rasamento flottante Floating neck ring Bague d'usure flottant	PTFE	PTFE	PTFE
22	Anello rasamento bloc. Blocking neck ring Bague d'usure bloquante	PTFE	PTFE	PTFE
23	Boccola cuscinetto Intermediate bush Douille intermédiaire	NBR	NBR	NBR
24	Corpo ultimo stadio Last diffuser Dernier corp d'étage	AISI 316	AISI 316	AISI 304
25	Girante Impeller Roue	AISI 304	AISI 316	AISI 904L
26	Cono elastico Split cone Cône élastique	AISI 316	AISI 316	AISI 316
27	Dado cono elastico Split cone nut Écrou cône élastique	AISI 316	AISI 316	AISI 329
28	Dado intermedio cono el. Intermediate split cone nut Écrou cône élastique	AISI 316	AISI 316	AISI 329
29	Dado reggispinta cono el. Split cone thrust nut Écrou butée cône élastique	AISI 316	AISI 316	AISI 329
30	Anello rasamento Neck ring Bague d'usure	PTFE	PTFE	PTFE
31	Girante intermedia Intermediate impeller Rou eintermédiaire	AISI 304	AISI 316	AISI 904L

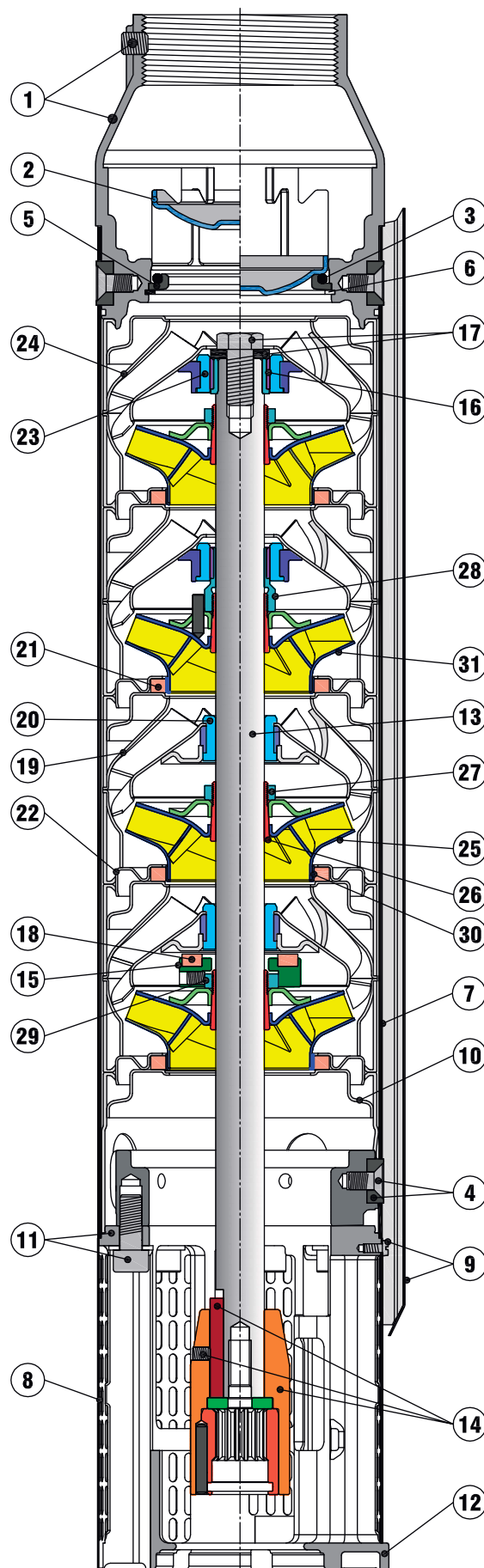



TABELLA DELLE CARATTERISTICHE IDRAULICHE 6"

6" HYDRAULIC FEATURES' CHART

TABLE DES CARACTÉRISTIQUES HYDRAULIQUES 6"

Tipo Type Type	Motore Motor Moteur		Q = Portata - Capacity - Débit																		
			l/sec	0	1,7	2,5	3,3	4,2	5,6	6,9	8,3	9,7	11,1	12,5							
			l/min	0	100	150	200	250	333	417	500	583	667	750							
			mpm	0	6	9	12	15	20	25	30	35	40	45							
FB6SX32/1	2	1,5		15			13	13	12	11	10	9	7	5							
FB6SX32/2	4	3		31			27	26	24	22	20	18	14	10							
FB6SX32/3	5,5	4		46			40	39	36	33	30	27	22	16							
FB6SX32/4	7,5	5,5		63			55	53	48	45	41	37	30	21							
FB6SX32/5	10	7,5		79			69	66	62	57	52	46	38	27							
FB6SX32/6	10	7,5		93			81	78	73	67	61	54	44	31							
FB6SX32/7	12,5	9,2		110			96	93	86	80	73	65	53	38							
FB6SX32/8	15	11		126			110	106	98	91	83	74	61	44							
FB6SX32/9	15	11		140			122	118	109	101	92	81	67	47							
FB6SX32/10	17,5	13		156			138	133	124	115	105	94	77	56							
FB6SX32/11	20	15		173			151	146	135	125	114	102	84	60							
FB6SX32/12	20	15		188			164	158	147	136	123	110	90	64							
FB6SX32/13	25	18,8	H(m)	205			179	173	161	149	136	121	100	72							
FB6SX32/14	25	18,8		220			192	186	172	160	146	129	107	77							
FB6SX32/15	30	22		237			207	200	186	172	157	140	116	84							
FB6SX32/16	30	22		252			220	212	197	183	166	148	122	86							
FB6SX32/17	30	22		267			233	225	208	193	176	156	129	93							
FB6SX32/18	30	22		281			246	237	220	203	185	164	136	97							
FB6SX32/19	35	26		302			264	255	237	220	201	180	149	109							
FB6SX32/20	35	26		317			277	267	249	231	211	188	156	114							
FB6SX32/21	35	26		332			290	280	260	242	220	197	163	118							
FB6SX32/22	40	30		347			304	293	272	252	230	205	169	123							
FB6SX32/23	40	30		362			317	305	283	263	239	213	176	127							
FB6SX32/24	40	30		377			329	316	295	273	249	221	182	131							

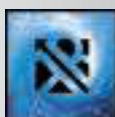
TABELLA DELLE CARATTERISTICHE IDRAULICHE 6"

6" HYDRAULIC FEATURES' CHART

TABLE DES CARACTÉRISTIQUES HYDRAULIQUES 6"

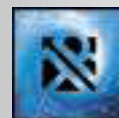

Tipo Type Type	Motore Motor Moteur		Q = Portata - Capacity - Débit															
			l/sec	0	1,7	2,5	3,3	4,2	5,6	6,9	8,3	9,7	11,1	12,5				
	l/min	0	100	150	200	250	333	417	500	583	667	750						
	Hp	kW	mc/h	0	6	9	12	15	20	25	30	35	40	45				
FB6SX32/25	50	37		395			345	333	309	287	262	234	193	140				
FB6SX32/26	50	37		410			358	346	321	298	271	242	200	145				
FB6SX32/27	50	37		425			371	358	332	308	281	250	206	149				
FB6SX32/28	50	37		440			384	370	344	319	290	258	213	153				
FB6SX32/29	50	37		455			397	383	355	329	299	266	219	157				
FB6SX32/30	50	37		469			410	395	366	339	309	274	225	161				
FB6SX32/31	60	45		490			428	413	384	356	324	289	239	174				
FB6SX32/32	60	45		505			441	425	395	366	334	298	246	178				
FB6SX32/33	60	45		520			454	438	407	377	343	306	252	182				
FB6SX32/34	60	45	H(m)	535			467	450	418	387	353	314	259	186				
FB6SX32/35	60	45		549			480	463	430	398	362	322	265	190				
FB6SX32/36	60	45		564			493	475	441	408	371	330	271	194				
FB6SX32/37	60	45		579			505	487	452	418	380	338	277	198				
FB6SX32/38	75	55		613			537	517	482	448	410	369	309	229				
FB6SX32/39	75	55		628			550	531	494	459	420	378	316	234				
FB6SX32/40	75	55		644			564	544	506	471	430	387	323	240				
FB6SX32/41	75	55		659			577	557	518	482	440	396	331	245				
FB6SX32/42	75	55		675			591	570	530	493	450	405	338	250				
FB6SX32/43	75	55		690			604	583	542	504	460	413	345	254				



TABELLA DELLE CARATTERISTICHE IDRAULICHE 6"

6" HYDRAULIC FEATURES' CHART

TABLE DES CARACTÉRISTIQUES HYDRAULIQUES 6"

Tipo Type Type	Motore Motor Moteur		Q = Portata - Capacity - Débit																	
			l/sec	0	1,4	2,8	4,2	6,9	8,3	9,7	11,1	12,5	13,9	15,3	16,7					
	l/min	0	83,3	167	250	417	500	583	667	750	833	917	1000							
	Hp	Kw	mc/h	0	5	10	15	25	30	35	40	45	50	55	60					
FB6SX47/1	2	1,5	13				11	10	10	9	8	8	7	6						
FB6SX47/2	4	3	26				23	21	19	18	17	15	13	11						
FB6SX47/3	5,5	4	39				34	31	29	27	25	23	20	17						
FB6SX47/4	7,5	5,5	53				45	42	38	36	33	30	27	22						
FB6SX47/5	10	7,5	66				57	52	48	45	42	38	34	28						
FB6SX47/6	12,5	9,2	81				70	65	60	56	50	46	42	36						
FB6SX47/7	12,5	9,2	93				80	75	69	64	58	53	48	41						
FB6SX47/8	15	11	106				92	85	79	72	66	60	54	46						
FB6SX47/9	17,5	13	122				106	98	91	84	76	70	63	54						
FB6SX47/10	17,5	13	134				116	108	100	92	83	76	69	59						
FB6SX47/11	20	15	146				127	118	109	100	91	83	75	64						
FB6SX47/12	25	18,5	161				140	130	121	111	101	92	83	71						
FB6SX47/13	25	18,5	174				151	140	130	119	108	99	89	76						
FB6SX47/14	25	18,5	186				161	150	139	127	115	105	95	81						
FB6SX47/15	30	22	201				174	162	150	138	125	114	103	88						
FB6SX47/16	30	22	213				185	172	159	146	132	121	109	93						
FB6SX47/17	30	22	225				195	181	168	154	139	127	115	98						
FB6SX47/18	35	26	244				212	198	183	169	153	140	127	109						
FB6SX47/19	35	26	257				223	208	193	177	161	147	133	114						
FB6SX47/20	35	26	269				234	218	202	185	168	154	139	120						
FB6SX47/21	40	30	282				244	227	211	194	176	161	145	124						
FB6SX47/22	40	30	294				255	237	220	202	183	167	151	129						
FB6SX47/23	40	30	307				265	247	229	210	190	174	157	134						
FB6SX47/24	50	37	322				280	260	241	222	201	184	166	143						
FB6SX47/25	50	37	335				290	270	250	230	208	191	172	148						
FB6SX47/26	50	37	347				301	280	259	238	216	197	178	152						
FB6SX47/27	50	37	360				311	289	268	246	223	204	184	157						
FB6SX47/28	50	37	372				321	299	277	254	230	210	190	162						
FB6SX47/29	60	45	390				339	315	292	268	243	223	201	173						
FB6SX47/30	60	45	403				349	325	301	277	251	229	207	178						
FB6SX47/31	60	45	415				360	335	310	285	258	236	213	183						
FB6SX47/32	60	45	428				370	344	319	293	265	243	219	187						
FB6SX47/33	60	45	440				380	354	328	300	272	249	225	192						
FB6SX47/34	75	55	469				411	383	355	328	298	272	248	216						
FB6SX47/35	75	55	483				422	394	365	337	306	279	255	221						
FB6SX47/36	75	55	496				434	404	374	346	314	287	261	227						
FB6SX47/37	75	55	509				445	415	384	355	322	294	268	233						
FB6SX47/38	75	55	522				456	425	394	364	330	302	275	238						
FB6SX47/39	75	55	535				468	436	404	373	338	309	281	244						
FB6SX47/40	75	55	548				479	446	413	381	346	316	288	249						

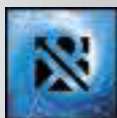
TABELLA DELLE CARATTERISTICHE IDRAULICHE 6"

6" HYDRAULIC FEATURES' CHART

TABLE DES CARACTÉRISTIQUES HYDRAULIQUES 6"

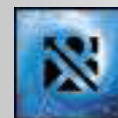

Tipo Type Type	Motore Motor Moteur		Q = Portata - Capacity - Débit																		
			l/sec	0	4,2	5,6	6,9	8,3	9,7	11,1	12,5	13,9	15,3	16,7	18,1	19,4	20,8	22,2			
	l/min	0	250	333	417	500	583	667	750	833	917	1000	1083	1167	1250	1333					
	Hp	kW	mc/h	0	15	20	25	30	35	40	45	50	55	60	65	70	75	80			
FB6SX60/1	3	2,2		13					11	10	9	8	8	7	7	6	5	4			
FB6SX60/2	5,5	4		27					21	19	17	17	16	15	14	12	11	8			
FB6SX60/3	7,5	5,5		40					32	29	26	25	24	23	21	19	16	13			
FB6SX60/4	10	7,5		54					43	38	35	33	32	30	28	25	21	17			
FB6SX60/5	12,5	9,2		68					54	49	44	42	40	38	36	32	28	22			
FB6SX60/6	15	11		81					64	58	53	50	48	45	42	38	32	26			
FB6SX60/7	17,5	13		95					76	70	65	62	59	56	52	46	40	33			
FB6SX60/8	20	15		108					86	79	74	70	66	63	59	52	44	37			
FB6SX60/9	20	15		120					96	88	82	77	73	70	65	57	49	40			
FB6SX60/10	25	18,5		135					108	99	92	87	83	79	73	65	56	46			
FB6SX60/11	25	18,5		147					117	108	100	95	90	85	79	70	60	50			
FB6SX60/12	30	22		161					129	119	110	104	99	94	88	77	66	55			
FB6SX60/13	30	22		174					139	127	118	112	106	101	94	83	71	59			
FB6SX60/14	35	26		190					153	141	131	124	118	112	105	93	80	68			
FB6SX60/15	35	26		203					163	150	140	132	126	119	112	99	85	72			
FB6SX60/16	40	30	H(m)	216					173	159	148	140	133	127	118	104	90	75			
FB6SX60/17	40	30		229					183	168	156	148	141	134	124	110	94	79			
FB6SX60/18	50	37		243					196	180	167	158	150	143	133	118	102	85			
FB6SX60/19	50	37		256					205	189	175	166	158	150	140	124	106	89			
FB6SX60/20	50	37		269					215	198	184	174	165	157	146	129	111	92			
FB6SX60/21	50	37		281					225	207	192	182	173	164	152	134	115	96			
FB6SX60/22	60	45		298					239	220	204	194	184	175	163	144	124	104			
FB6SX60/23	60	45		311					249	229	213	202	191	182	170	150	129	108			
FB6SX60/24	60	45		323					259	238	221	210	199	189	176	155	133	112			
FB6SX60/25	60	45		336					268	247	229	217	206	196	182	161	138	115			
FB6SX60/26	60	45		348					278	256	237	225	214	203	188	166	142	118			
FB6SX60/27	75	55		373					303	279	259	245	233	222	209	186	162	138			
FB6SX60/28	75	55		386					314	289	268	253	242	229	216	193	167	142			
FB6SX60/29	75	55		399					324	298	277	262	250	237	223	199	172	146			
FB6SX60/30	75	55		413					335	308	286	270	258	245	230	205	177	151			
FB6SX60/31	75	55		426					345	317	295	279	266	252	237	211	183	155			

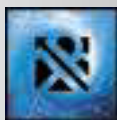

FB6SX32

DATI DELLE PRESTAZIONI PERFORMANCES' DATA DONNÉES DES PERFORMANCES

Tipo Type Type	Motore Moteur Moteur		Q = Portata - Capacity - Débit									
			l/sec	0	3,3	4,2	5,6	6,9	8,3	9,7	11,1	12,5
			l/min	0	200	250	333	417	500	583	667	750
Hp	Kw	m ³ /h	0	12	15	20	25	30	35	40	45	
FB6SX32/1 + 4B2	2	1,5	15	13	13	12	11	10	9	7	5	
FB6SX32/2 + 4B4	4	3	31	27	28	24	23	20	18	14	10	
FB6SX32/3 + 6F5	5,5	4	48	40	38	36	33	30	27	22	15	
FB6SX32/4 + 6F7	7,5	5,5	50	55	53	48	45	41	37	30	21	
FB6SX32/5 + 6F10	10	7,5	79	88	86	82	87	82	86	86	27	
FB6SX32/6 + 6F10	10	7,5	80	81	79	73	67	61	54	44	31	
FB6SX32/7 + 6F12	12,5	9,2	110	96	93	86	80	73	65	53	38	
FB6SX32/8 + 6F15	15	11	126	110	108	98	91	83	74	61	44	
FB6SX32/9 + 6F15	15	11	140	122	118	109	101	92	81	67	47	
FB6SX32/10 + 6F17	17,5	13	155	138	133	124	115	105	94	77	56	
FB6SX32/11 + 6F20	20	15	172	151	146	135	125	114	102	84	60	
FB6SX32/12 + 6F20	20	15	188	164	158	147	136	123	110	90	64	
FB6SX32/13 + 6F25	25	18,5	205	179	173	161	149	138	121	100	72	
FB6SX32/14 + 6F25	25	18,5	225	192	185	172	159	148	129	107	77	
FB6SX32/15 + 6F30	30	22	237	207	200	188	172	157	140	118	84	
FB6SX32/16 + 6F30	30	22	252	220	212	197	183	168	148	123	88	
FB6SX32/17 + 6F30	30	22	267	233	225	209	193	178	156	129	93	
FB6SX32/18 + 6F30	30	22	281	245	237	220	203	185	164	135	97	
FB6SX32/19 + 6F40	35	26	302	264	255	237	220	201	180	149	108	
FB6SX32/20 + 6F40	35	26	312	277	267	249	231	211	185	158	114	
FB6SX32/21 + 6F40	35	26	332	290	280	260	242	220	197	163	116	
FB6SX32/22 + 6F40	40	30	347	304	293	272	252	230	205	188	123	



Dimensioni e pesi

Overall dimensions and weights - Dimensions d'ensemble et poids

Tipo Type Type	Cv	kg	kW	A (mm)	B (mm)	C (mm)	D (mm)	E max (mm)	DN	Peso - Weight - Poids		
										A (kg)	B (kg)	C (kg)
FB6SX32/1 + 4B2	2	1,6	821	535	368	94	143			23	13	10
FB6SX32/2 + 4B4	4	3	1039	535	505	94	143			28	13	13
FB6SX32/3 + 6F5	5,5	4	1217	520	587	94	143			58	15	44
FB6SX32/4 + 6F7	7,5	5,5	1333	705	627	94	143			63	17	46
FB6SX32/5 + 6F10	10	7,5	1458	721	667	94	143			88	19	50
FB6SX32/6 + 6F10	10	7,5	1543	875	667	94	143			71	21	50
FB6SX32/7 + 6F12	12,5	9,2	1688	962	667	94	143			77	23	54
FB6SX32/8 + 6F15	15	11	1814	1047	787	94	143			88	25	61
FB6SX32/9 + 6F15	15	11	1900	1133	787	94	143			88	27	61
FB6SX32/10 + 6F17	17,5	13	1985	1218	787	94	143			97	29	62
FB6SX32/11 + 6F20	20	15	2131	1304	827	94	143			100	32	68
FB6SX32/12 + 6F20	20	15	2216	1389	827	94	143			102	34	68
FB6SX32/13 + 6F25	25	18,5	2372	1475	867	145	140		G 3"	111	36	75
FB6SX32/14 + 6F25	25	18,5	2457	1560	867	145	140		G 3"	113	38	75
FB6SX32/15 + 6F30	30	22	2613	1646	967	145	140		G 3"	122	40	82
FB6SX32/16 + 6F30	30	22	2698	1731	967	145	140		G 3"	124	42	82
FB6SX32/17 + 6F30	30	22	2783	1816	967	145	140		G 3"	126	44	82
FB6SX32/18 + 6F30	30	22	2868	1902	967	145	140		G 3"	128	46	82
FB6SX32/19 + 6F40	35	26	3014	1987	1027	145	140		G 3"	151	48	103
FB6SX32/20 + 6F40	35	26	3100	2073	1027	145	140		G 3"	153	50	103
FB6SX32/21 + 6F40	35	26	3185	2158	1027	145	140		G 3"	155	52	103
FB6SX32/22 + 6F40	40	30	3270	2243	1027	145	140		G 3"	158	55	103

* Non consigliata per montaggio in posizione orizzontale

* This electropump isn't recommended for horizontal assemblage

* Cette électropompe n'est pas recommandée pour le montage en position horizontale

Tolleranze secondo EN ISO 9906 app.A Gr.2 - Tolerances according to EN ISO 9906 anx.A Gr.2 - Tolérances conformes EN ISO 9906 ann.A Gr.2
Rispetta il Reg. UE n° 547/2012 con MEI = 0.40 - Comply with Reg. UE n° 547/2012 with MEI = 0.40 - Conforme Reg. UE n°547/2012 avec MEI =0.40

CURVE DELLE PRESTAZIONI

PERFORMANCES' CURVES

COURBES DES PERFORMANCES

FB6SX32

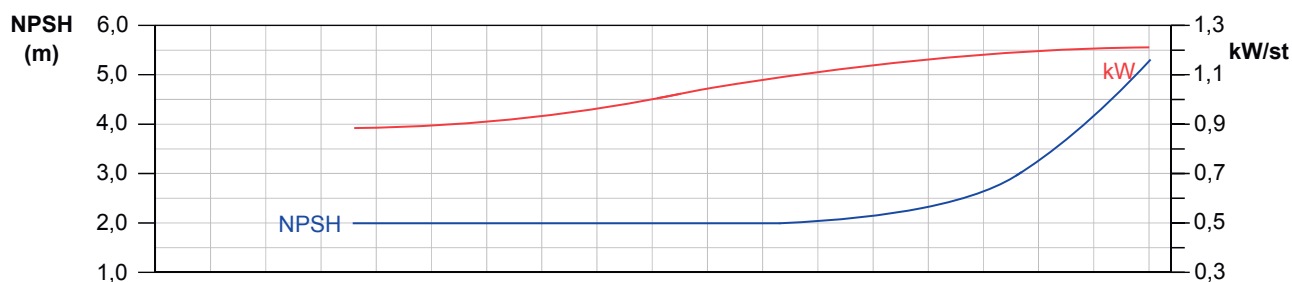
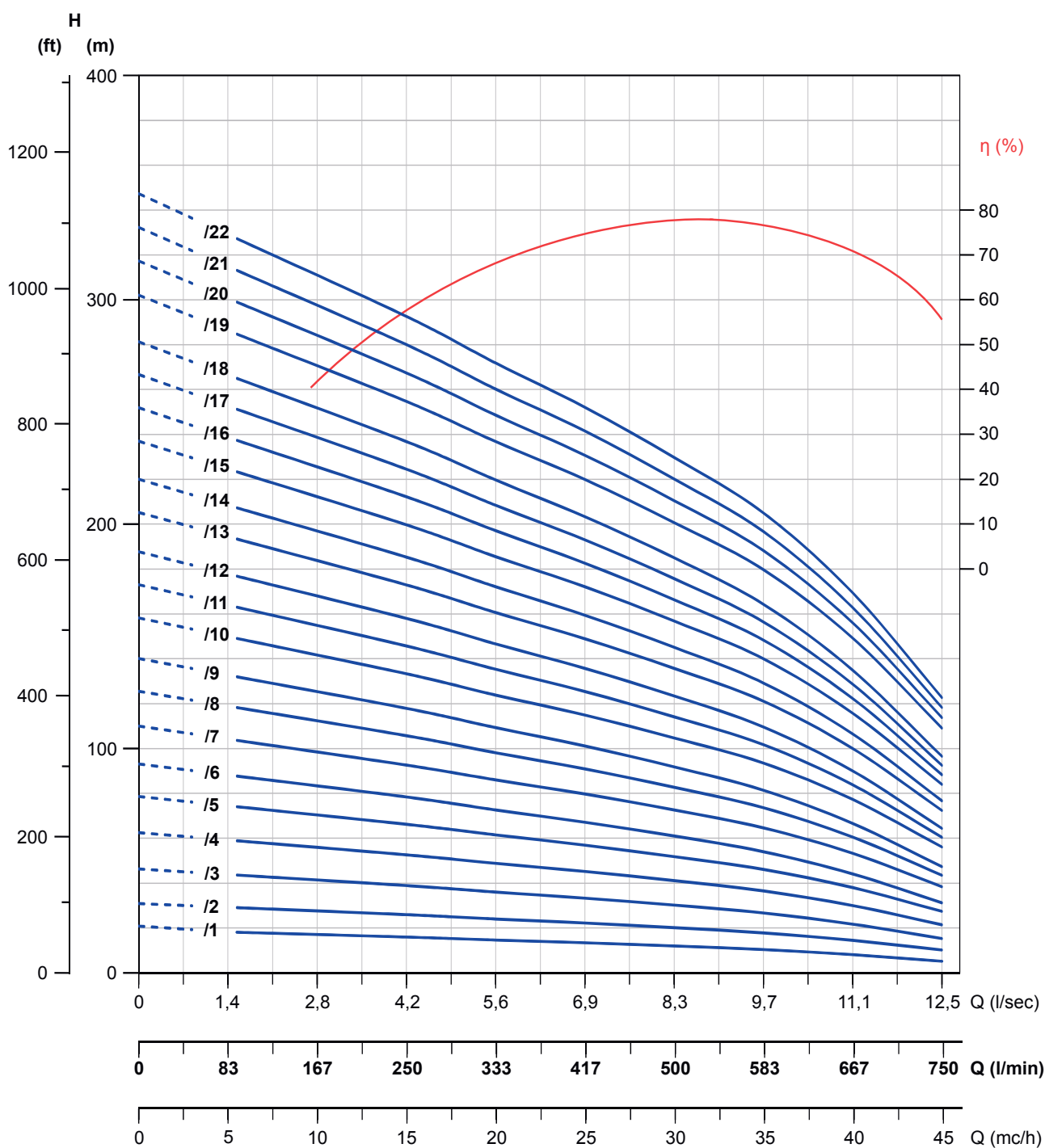
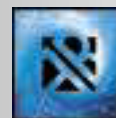

Tolleranze secondo EN ISO 9906 app.A Gr.2 - Tolerances according to EN ISO 9906 anx.A Gr.2 - Tolérances conformes EN ISO 9906 ann.A Gr.2
 Rispetta il Reg. UE n° 547/2012 con MEI = 0.40 - Comply with Reg. UE n° 547/2012 with MEI = 0.40 - Conforme Reg. UE n°547/2012 avec MEI=0.40

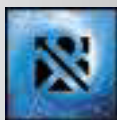

Tipo Type Type	Motore Motors 2900 g/m Moteurs		Q = Portata - Capacity - Débit									
	Cv Hp	Kw	l/sec	0	3,3	4,2	5,6	6,9	8,3	9,7	11,1	12,5
			l/min	0	200	250	333	417	500	583	667	750
			mc/h	0	12	15	20	25	30	35	40	45
FB6SX32/23 + 6F40*	40	30	H(m)	362	317	305	283	263	239	213	176	127
FB6SX32/24 + 6F40*	40	30		377	329	318	295	273	249	221	182	131
FB6SX32/25 + 6F50*	50	37		395	345	333	309	287	262	234	193	140
FB6SX32/26 + 6F50*	50	37		410	358	346	321	298	271	242	200	145
FB6SX32/27 + 6F50*	50	37		425	371	358	332	308	281	250	206	149
FB6SX32/28 + 6F50*	50	37		440	384	370	344	319	290	258	213	153
FB6SX32/29 + 6F50*	50	37		455	397	383	355	329	299	266	219	157
FB6SX32/30 + 6F50*	50	37		469	410	395	366	339	309	274	225	161
FB6SX32/31 + 6F60*	60	45		490	428	413	384	356	324	289	239	174
FB6SX32/32 + 6F60*	60	45		505	441	425	395	366	334	298	246	178
FB6SX32/33 + 6F60*	60	45		520	454	438	407	377	343	306	252	182
FB6SX32/34 + 6F60*	60	45		535	467	450	418	387	353	314	259	186
FB6SX32/35 + 6F60*	60	45		549	480	463	430	398	362	322	265	190
FB6SX32/36 + 6F60*	60	45		564	493	475	441	408	371	330	271	194
FB6SX32/37 + 6F60*	60	45		579	505	487	452	418	380	338	277	198
FB6SX32/38 + 8F75*	75	55		613	537	517	482	448	410	369	309	229
FB6SX32/39 + 8F75*	75	55		628	550	531	494	459	420	378	316	234
FB6SX32/40 + 8F75*	75	55		644	564	544	506	471	430	387	323	240
FB6SX32/41 + 8F75*	75	55		659	577	557	518	482	440	396	331	245
FB6SX32/42 + 8F75*	75	55		675	591	570	530	493	450	405	338	250
FB6SX32/43 + 8F75*	75	55		690	604	583	542	504	460	413	345	254

Dimensioni e pesi

Overall dimensions and weights - Dimensions d'encombrement et poids

Tipo Type Type	Cv Hp	Kw	A (mm)	B (mm)	C (mm)	D (mm)	ø max (mm)	DN	Peso - Weight - Poids		
									A (kg)	B (kg)	C (kg)
									FB6SX32/23 + 6F40*	40	30
FB6SX32/24 + 6F40*	40	30	3441	2414	1027	162	59	103			
FB6SX32/25 + 6F50*	50	37	3796	2499	1297	177	61	116			
FB6SX32/26 + 6F50*	50	37	3882	2585	1297	179	63	116			
FB6SX32/27 + 6F50*	50	37	3967	2670	1297	181	65	116			
FB6SX32/28 + 6F50*	50	37	4052	2755	1297	183	67	116			
FB6SX32/29 + 6F50*	50	37	4138	2841	1297	185	69	116			
FB6SX32/30 + 6F50*	50	37	4223	2926	1297	187	71	116			
FB6SX32/31 + 6F60*	60	45	4438	3111	1327	193	72	121			
FB6SX32/32 + 6F60*	60	45	4524	3197	1327	197	76	121			
FB6SX32/33 + 6F60*	60	45	4609	3282	1327	199	78	121			
FB6SX32/34 + 6F60*	60	45	4695	3368	1327	201	80	121			
FB6SX32/35 + 6F60*	60	45	4780	3453	1327	203	82	121			
FB6SX32/36 + 6F60*	60	45	4865	3538	1327	206	85	121			
FB6SX32/37 + 6F60*	60	45	4951	3624	1327	208	87	121			
FB6SX32/38 + 8F75*	75	55	5058	3709	1349	192	192	276	92	184	
FB6SX32/39 + 8F75*	75	55	5143	3794	1349			278	94	184	
FB6SX32/40 + 8F75*	75	55	5228	3880	1349			281	97	184	
FB6SX32/41 + 8F75*	75	55	5314	3965	1349			282	98	184	
FB6SX32/42 + 8F75*	75	55	5399	4051	1349			283	99	184	
FB6SX32/43 + 8F75*	75	55	5484	4136	1349			284	100	184	



* Non consigliata per montaggio in posizione orizzontale
 * This electropump isn't recommended for horizontal assemblage
 * Cette électropompe n'est pas recommandée pour le montage en position horizontale

CURVE DELLE PRESTAZIONI

PERFORMANCES' CURVES

COURBES DES PERFORMANCES

FB6SX32

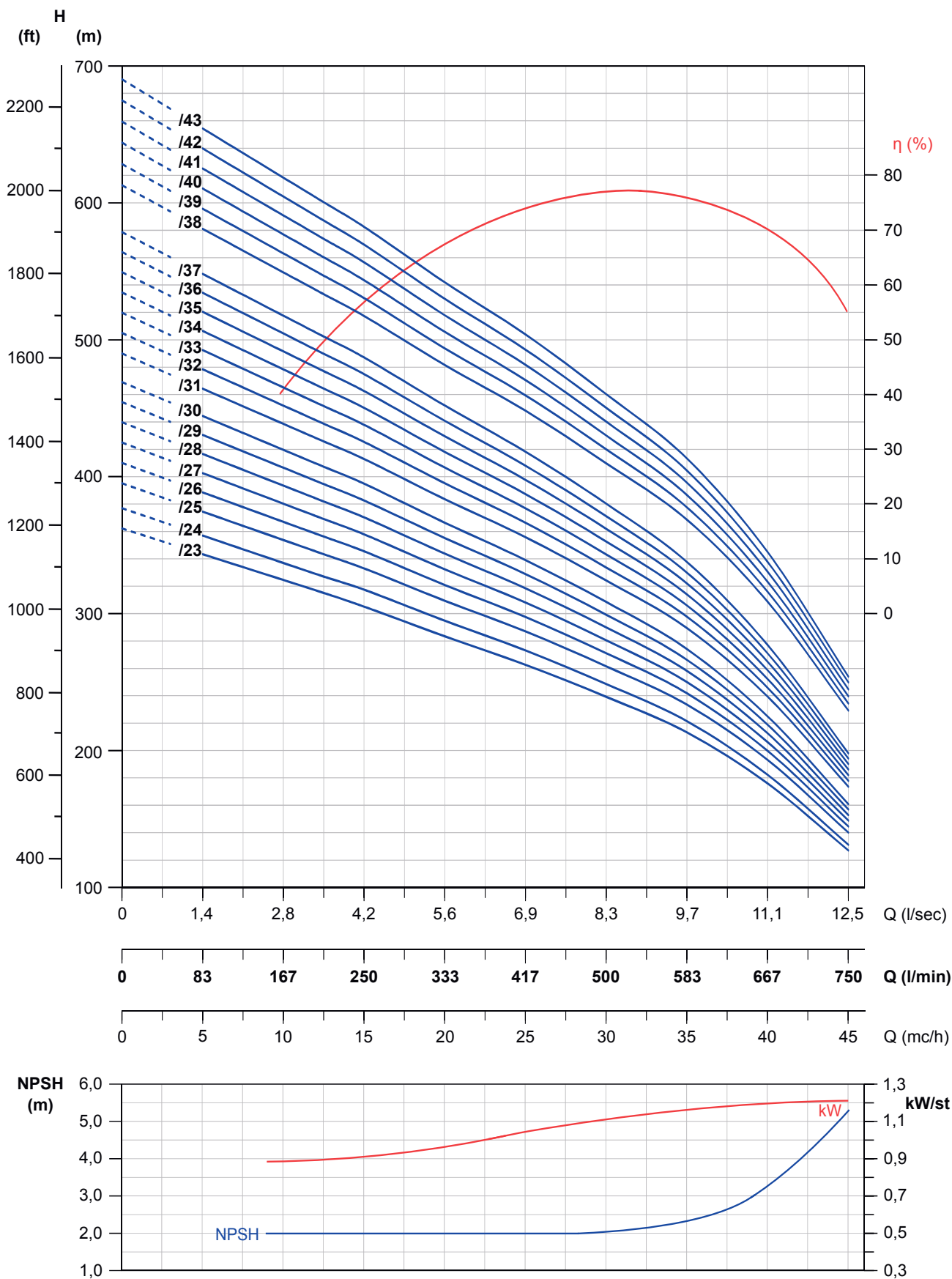
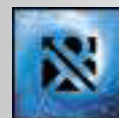

Tolleranze secondo EN ISO 9906 app.A Gr.2 - Tolerances according to EN ISO 9906 anx.A Gr.2 - Tolérances conformes EN ISO 9906 ann.A Gr.2
 Rispetta il Reg. UE n° 547/2012 con MEI = 0.40 - Comply with Reg. UE n° 547/2012 with MEI = 0.40 - Conforme Reg. UE n°547/2012 avec MEI=0.40

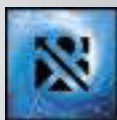

FB6SX47

DATI DELLE PRESTAZIONI PERFORMANCES' DATA DONNÉES DES PERFORMANCES

Tipo Type Type	Motore Motors 2900 g/m Moteurs		Q = Portata - Capacity - Débit									
	Cv Hp	Kw	l/sec	0	6,9	8,3	9,7	11,1	12,5	13,9	15,3	16,7
			l/min	0	417	500	583	667	750	833	917	1000
			mc/h	0	25	30	35	40	45	50	55	60
FB6SX47/1 + 4B2	2	1,5	H(m)	13	11	10	10	9	8	8	7	6
FB6SX47/2 + 4B4	4	3		26	23	21	19	18	17	15	13	11
FB6SX47/3 + 6F5	5,5	4		39	34	31	29	27	25	23	20	17
FB6SX47/4 + 6F7	7,5	5,5		53	45	42	38	36	33	30	27	22
FB6SX47/5 + 6F10	10	7,5		66	57	52	48	45	42	38	34	28
FB6SX47/6 + 6F12	12,5	9,2		81	70	65	60	56	50	46	42	36
FB6SX47/7 + 6F12	12,5	9,2		93	80	75	69	64	58	53	48	41
FB6SX47/8 + 6F15	15	11		106	92	85	79	72	66	60	54	46
FB6SX47/9 + 6F17	17,5	13		122	106	98	91	84	76	70	63	54
FB6SX47/10 + 6F17	17,5	13		134	116	108	100	92	83	76	69	59
FB6SX47/11 + 6F20	20	15		146	127	118	109	100	91	83	75	64
FB6SX47/12 + 6F25	25	18,5		161	140	130	121	111	101	92	83	71
FB6SX47/13 + 6F25	25	18,5		174	151	140	130	119	108	99	89	76
FB6SX47/14 + 6F25	25	18,5		186	161	150	139	127	115	105	95	81
FB6SX47/15 + 6F30	30	22		201	174	162	150	138	125	114	103	88
FB6SX47/16 + 6F30	30	22		213	185	172	159	146	132	121	109	93
FB6SX47/17 + 6F30	30	22		225	195	181	168	154	139	127	115	98
FB6SX47/18 + 6F35	35	26		244	212	198	183	169	153	140	127	109
FB6SX47/19 + 6F35	35	26		257	223	208	193	177	161	147	133	114
FB6SX47/20 + 6F35	35	26		269	234	218	202	185	168	154	139	120

Dimensioni e pesi

Overall dimensions and weights - Dimensions d'encombrement et poids

Tipo Type Type	Cv Hp	Kw	A (mm)	B (mm)	C (mm)	D (mm)	ø max (mm)	DN	Peso - Weight - Poids		
									A (kg)	B (kg)	C (kg)
FB6SX47/1 + 4B2	2	1,5	978	592	386	94	143	G 3"	24	14	10
FB6SX47/2 + 4B4	4	3	1097	592	505				26	14	13
FB6SX47/3 + 6F5	5,5	4	1303	706	597	145	145	G 3"	60	16	44
FB6SX47/4 + 6F7	7,5	5,5	1447	820	627				65	19	46
FB6SX47/5 + 6F10	10	7,5	1601	934	667				71	21	50
FB6SX47/6 + 6F12	12,5	9,2	1744	1047	697				78	24	54
FB6SX47/7 + 6F12	12,5	9,2	1858	1161	697				81	27	54
FB6SX47/8 + 6F15	15	11	2042	1275	767				90	29	61
FB6SX47/9 + 6F17	17,5	13	2156	1389	767				94	32	62
FB6SX47/10 + 6F17	17,5	13	2270	1503	767				96	34	62
FB6SX47/11 + 6F20	20	15	2444	1617	827				105	37	68
FB6SX47/12 + 6F25	25	18,5	2628	1731	897				115	40	75
FB6SX47/13 + 6F25	25	18,5	2742	1845	897				499	424	75
FB6SX47/14 + 6F25	25	18,5	2856	1959	897				120	45	75
FB6SX47/15 + 6F30	30	22	3040	2073	967				129	47	82
FB6SX47/16 + 6F30	30	22	3154	2187	967				132	50	82
FB6SX47/17 + 6F30	30	22	3267	2300	967				135	53	82
FB6SX47/18 + 6F35	35	26	3381	2414	967				144	55	89
FB6SX47/19 + 6F35	35	26	3495	2528	967				147	58	89
FB6SX47/20 + 6F35	35	26	3609	2642	967				149	60	89



Tolleranze secondo EN ISO 9906 app.A Gr.2 - Tolerances according to EN ISO 9906 anx.A Gr.2 - Tolérances conformes EN ISO 9906 ann.A Gr.2
Rispetta il Reg. UE n° 547/2012 con MEI = 0.40 - Comply with Reg. UE n° 547/2012 with MEI = 0.40 - Conforme Reg. UE n°547/2012 avec MEI =0.40

CURVE DELLE PRESTAZIONI

PERFORMANCES' CURVES

COURBES DES PERFORMANCES

FB6SX47

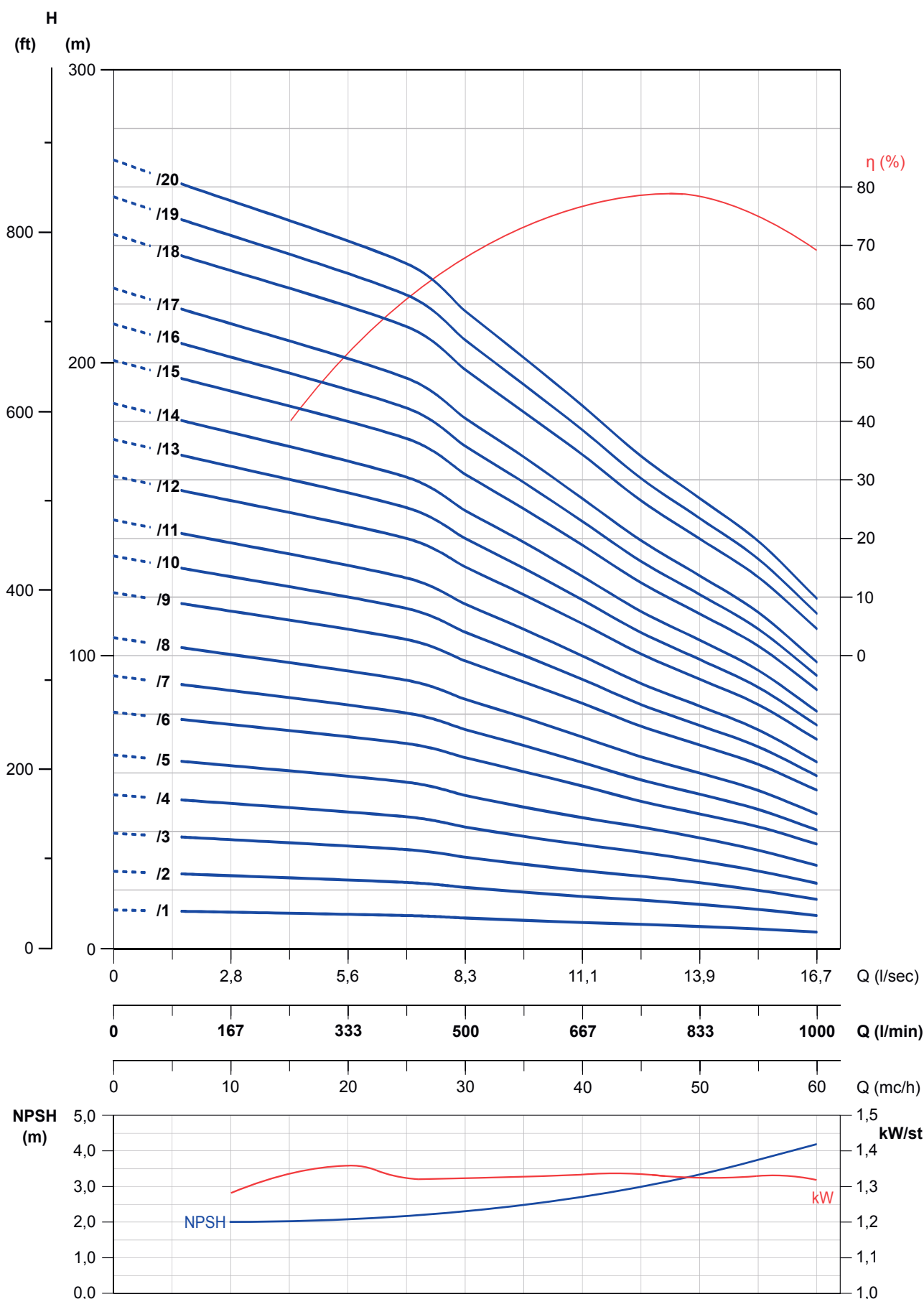
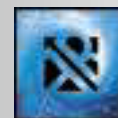

Tolleranze secondo EN ISO 9906 app.A Gr.2 - Tolerances according to EN ISO 9906 anx.A Gr.2 - Tolérances conformes EN ISO 9906 ann.A Gr.2
 Rispetta il Reg. UE n° 547/2012 con MEI = 0.40 - Comply with Reg. UE n° 547/2012 with MEI = 0.40 - Conforme Reg. UE n°547/2012 avec MEI=0.40

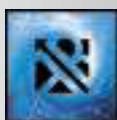

FB6SX47

DATI DELLE PRESTAZIONI PERFORMANCES' DATA DONNÉES DES PERFORMANCES

Tipo Type Type	Motore Motors 2900 g/m Moteurs		Q = Portata - Capacity - Débit									
	Cv Hp	Kw	l/sec	0	6,9	8,3	9,7	11,1	12,5	13,9	15,3	16,7
			l/min	0	417	500	583	667	750	833	917	1000
			mc/h	0	25	30	35	40	45	50	55	60
FB6SX47/21 + 6F40*	40	30	H (m)	282	244	227	211	194	176	161	145	124
FB6SX47/22 + 6F40*	40	30		294	255	237	220	202	183	167	151	129
FB6SX47/23 + 6F40*	40	30		307	265	247	229	210	190	174	157	134
FB6SX47/24 + 6F50*	50	37		322	280	260	241	222	201	184	166	143
FB6SX47/25 + 6F50*	50	37		335	290	270	250	230	208	191	172	148
FB6SX47/26 + 6F50*	50	37		347	301	280	259	238	216	197	178	152
FB6SX47/27 + 6F50*	50	37		360	311	289	268	246	223	204	184	157
FB6SX47/28 + 6F50*	50	37		372	321	299	277	254	230	210	190	162
FB6SX47/29 + 6F60*	60	45		390	339	315	292	268	243	223	201	173
FB6SX47/30 + 6F60*	60	45		403	349	325	301	277	251	229	207	178
FB6SX47/31 + 6F60*	60	45		415	360	335	310	285	258	236	213	183
FB6SX47/32 + 6F60*	60	45		428	370	344	319	293	265	243	219	187
FB6SX47/33 + 6F60*	60	45		440	380	354	328	300	272	249	225	192
FB6SX47/34 + 8F75*	75	55		469	411	383	355	328	298	272	248	216
FB6SX47/35 + 8F75*	75	55		483	422	394	365	337	306	279	255	221
FB6SX47/36 + 8F75*	75	55		496	434	404	374	346	314	287	261	227
FB6SX47/37 + 8F75*	75	55		509	445	415	384	355	322	294	268	233
FB6SX47/38 + 8F75*	75	55		522	456	425	394	364	330	302	275	238
FB6SX47/39 + 8F75*	75	55		535	468	436	404	373	338	309	281	244
FB6SX47/40 + 8F75*	75	55		548	479	446	413	381	346	316	288	249

Dimensioni e pesi

Overall dimensions and weights - Dimensions d'encombrement et poids

Tipo Type Type	Cv Hp	Kw	A (mm)	B (mm)	C (mm)	D (mm)	ø max (mm)	DN	Peso - Weight - Poids		
									A (kg)	B (kg)	C (kg)
									FB6SX47/21 + 6F40*	40	30
FB6SX47/22 + 6F40*	40	30	3896	2869	1027	169	66	103			
FB6SX47/23 + 6F40*	40	30	4010	2983	1027	171	68	103			
FB6SX47/24 + 6F50*	50	37	4393	3096	1297	187	71	116			
FB6SX47/25 + 6F50*	50	37	4507	3210	1297	189	73	116			
FB6SX47/26 + 6F50*	50	37	4621	3324	1297	192	76	116			
FB6SX47/27 + 6F50*	50	37	4735	3438	1297	195	79	116			
FB6SX47/28 + 6F50*	50	37	4849	3552	1297	198	82	116			
FB6SX47/29 + 6F60*	60	45	5093	3766	1327	206	85	121			
FB6SX47/30 + 6F60*	60	45	5207	3880	1327	208	87	121			
FB6SX47/31 + 6F60*	60	45	5321	3994	1327	211	90	121			
FB6SX47/32 + 6F60*	60	45	5434	4107	1327	213	92	121			
FB6SX47/33 + 6F60*	60	45	5548	4221	1327	216	95	121			
FB6SX47/34 + 8F75*	75	55	5684	4335	1349	192	192	G 3"	285	101	184
FB6SX47/35 + 8F75*	75	55	5798	4449	1349				287	103	184
FB6SX47/36 + 8F75*	75	55	5911	4563	1349				290	106	184
FB6SX47/37 + 8F75*	75	55	6025	4677	1349				293	109	184
FB6SX47/38 + 8F75*	75	55	6139	4791	1349				295	111	184
FB6SX47/39 + 8F75*	75	55	6253	4905	1349				298	114	184
FB6SX47/40 + 8F75*	75	55	6367	5019	1349				301	117	184



* Non consigliata per montaggio in posizione orizzontale

* This electropump isn't recommended for horizontal assemblage

* Cette électropompe n'est pas recommandée pour le montage en position horizontale

CURVE DELLE PRESTAZIONI

PERFORMANCES' CURVES

COURBES DES PERFORMANCES

FB6SX47

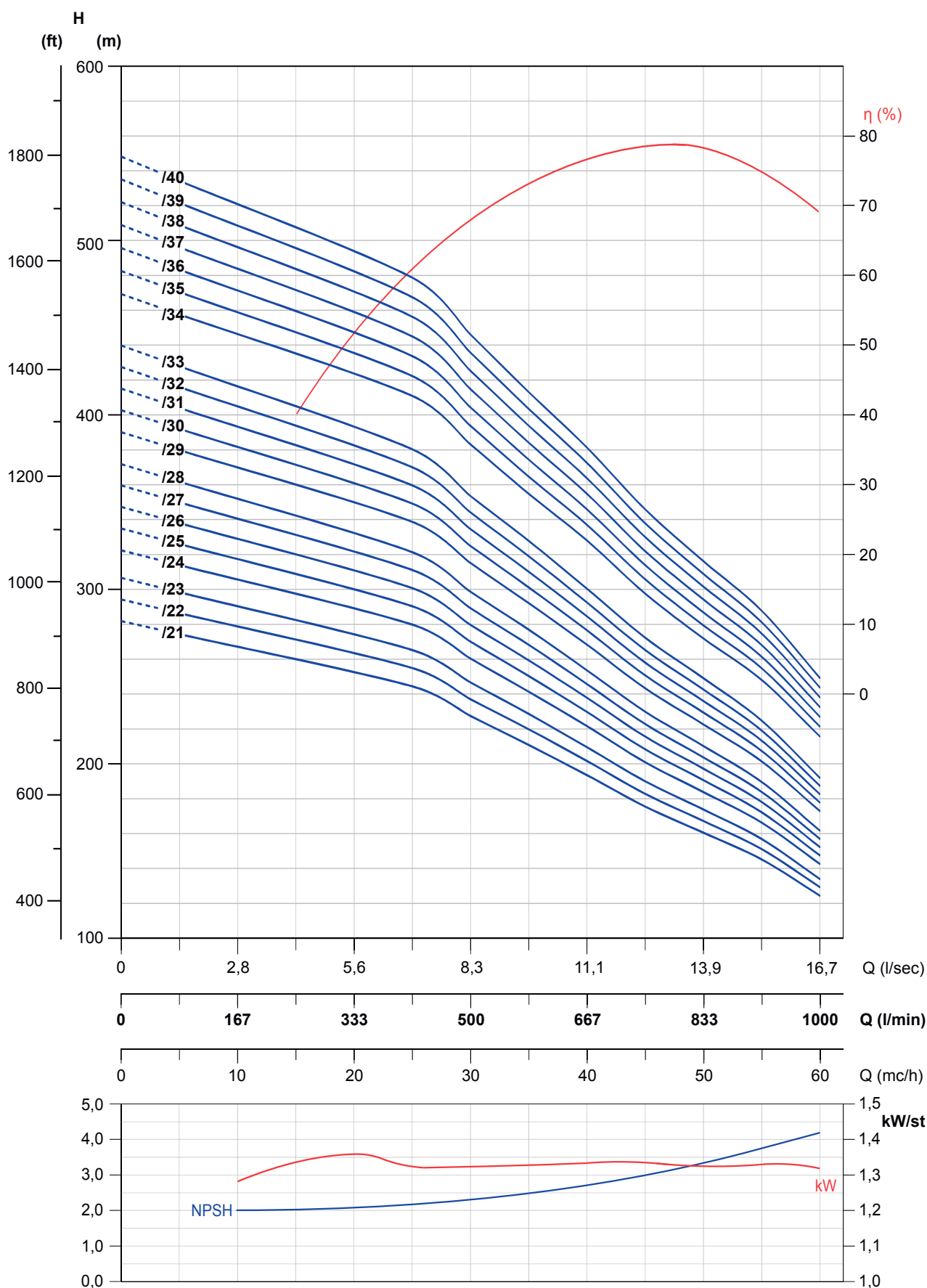
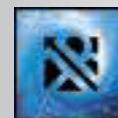

Tolleranze secondo EN ISO 9906 app.A Gr.2 - Tolerances according to EN ISO 9906 anx.A Gr.2 - Tolérances conformes EN ISO 9906 ann.A Gr.2
 Rispetta il Reg. UE n° 547/2012 con MEI = 0.40 - Comply with Reg. UE n° 547/2012 with MEI = 0.40 - Conforme Reg. UE n°547/2012 avec MEI = 0.40

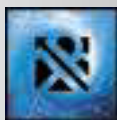

Tipo Type Type	Motore Motors 2900 g/m Moteurs		Q = Portata - Capacity - Débit										
			l/sec	0	9,7	12,5	15,3	16,7	18,1	19,4	20,8	22,2	
				l/min	0	583	750	917	1000	1083	1167	1250	1333
					mc/h	0	35	45	55	60	65	70	75
FB6SX60/1 + 4B3	3	2,2	H(m)	13	11	9	8	7	7	6	5	4	
FB6SX60/2 + 6F5	5,5	4		27	21	17	16	15	14	12	11	8	
FB6SX60/3 + 6F7	7,5	5,5		40	32	26	24	23	21	19	16	13	
FB6SX60/4 + 6F10	10	7,5		54	43	35	32	30	28	25	21	17	
FB6SX60/5 + 6F12	12,5	9,2		68	54	44	40	38	36	32	28	22	
FB6SX60/6 + 6F15	15	11		81	64	53	48	45	42	38	32	26	
FB6SX60/7 + 6F17	17,5	13		95	76	65	59	56	52	46	40	33	
FB6SX60/8 + 6F20	20	15		108	86	74	66	63	59	52	44	37	
FB6SX60/9 + 6F20	20	15		120	96	82	73	70	65	57	49	40	
FB6SX60/10 + 6F25	25	18,5		135	108	92	83	79	73	65	56	46	
FB6SX60/11 + 6F25	25	18,5		147	117	100	90	85	79	70	60	50	
FB6SX60/12 + 6F30	30	22		161	129	110	99	94	88	77	66	55	
FB6SX60/13 + 6F30	30	22		174	139	118	106	101	94	83	71	59	
FB6SX60/14 + 6F35	35	26		190	153	131	118	112	105	93	80	68	
FB6SX60/15 + 6F35	35	26		203	163	140	126	119	112	99	85	72	
FB6SX60/16 + 6F40*	40	30		216	173	148	133	127	118	104	90	75	

Dimensioni e pesi

Overall dimensions and weights - Dimensions d'encombrement et poids

Tipo Type Type	Cv Hp	Kw	A (mm)	B (mm)	C (mm)	D (mm)	ø max (mm)	DN	Peso - Weight - Poids		
									A (kg)	B (kg)	C (kg)
									FB6SX60/1 + 4B3	3	2
FB6SX60/2 + 6F5	5,5	4	1189	592	597	145	145	G 3"	58	14	44
FB6SX60/3 + 6F7	7,5	5,5	1333	706	627				62	16	46
FB6SX60/4 + 6F10	10	7,5	1487	820	667				69	19	50
FB6SX60/5 + 6F12	12,5	9,2	1631	934	697				75	21	54
FB6SX60/6 + 6F15	15	11	1814	1047	767				85	24	61
FB6SX60/7 + 6F17	17,5	13	1928	1161	767				89	27	62
FB6SX60/8 + 6F20	20	15	2102	1275	827				97	29	68
FB6SX60/9 + 6F20	20	15	2216	1389	827				100	32	68
FB6SX60/10 + 6F25	25	18,5	2400	1503	897				109	34	75
FB6SX60/11 + 6F25	25	18,5	2514	1617	897				112	37	75
FB6SX60/12 + 6F30	30	22	2698	1731	967				122	40	82
FB6SX60/13 + 6F30	30	22	2812	1845	967				124	42	82
FB6SX60/14 + 6F35	35	26	2986	1959	1027				134	45	89
FB6SX60/15 + 6F35	35	26	3100	2073	1027				136	47	89
FB6SX60/16 + 6F40*	40	30	3353	2186	1167				153	50	103



* Non consigliata per montaggio in posizione orizzontale

* This electropump isn't recommended for horizontal assembly

* Cette électropompe n'est pas recommandée pour le montage en position horizontale

CURVE DELLE PRESTAZIONI

PERFORMANCES' CURVES

COURBES DES PERFORMANCES

FB6SX60

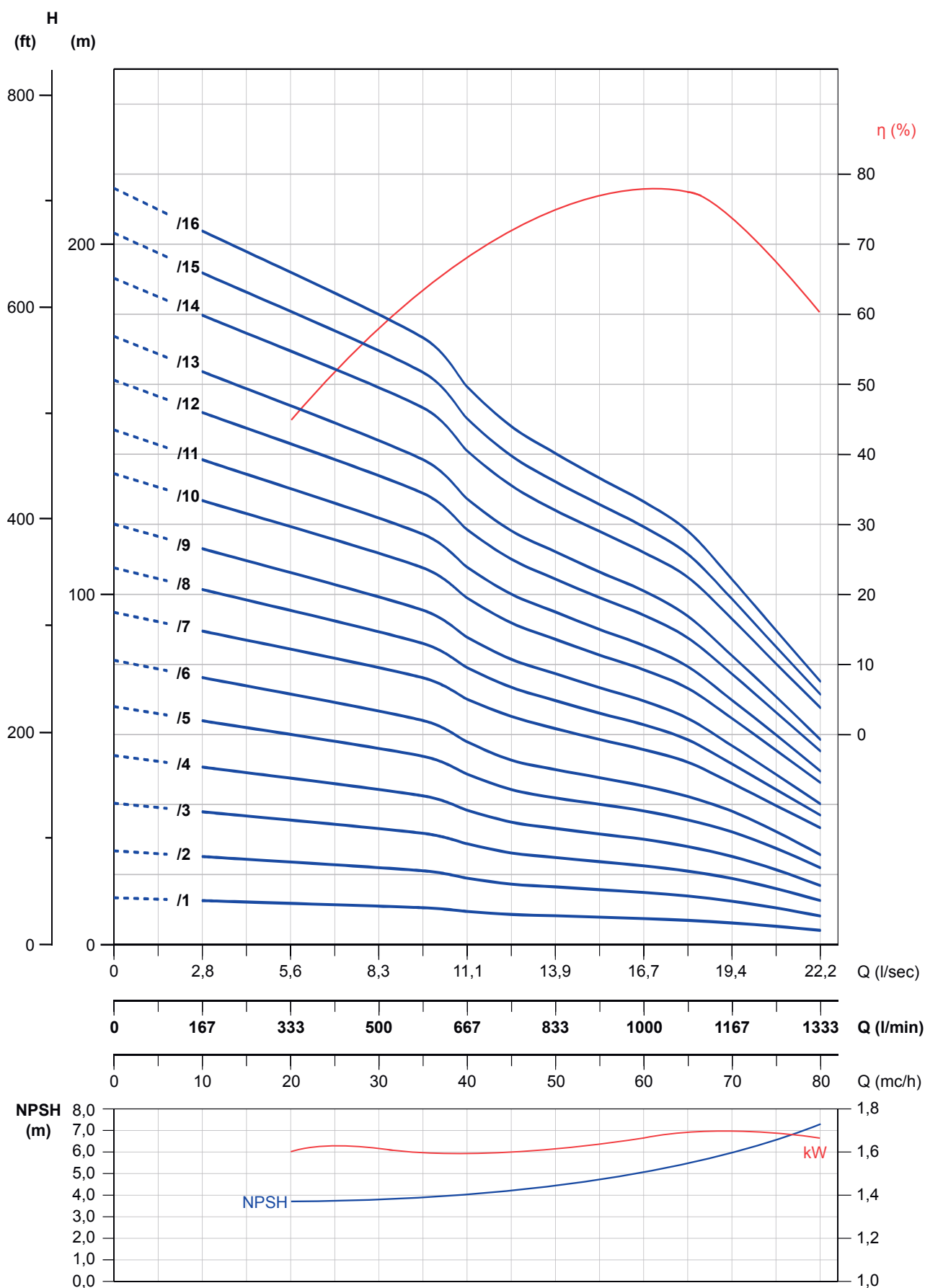
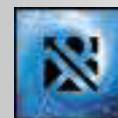

Tolleranze secondo EN ISO 9906 app.A Gr.2 - Tolerances according to EN ISO 9906 anx.A Gr.2 - Tolérances conformes EN ISO 9906 ann.A Gr.2
 Rispetta il Reg. UE n° 547/2012 con MEI = 0.40 - Comply with Reg. UE n° 547/2012 with MEI = 0.40 - Conforme Reg. UE n°547/2012 avec MEI =0.40

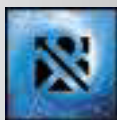

Tipo Type Type	Motore Motors 2900 g/m Moteurs		Q = Portata - Capacity - Débit									
	Cv Hp	Kw	l/sec	0	9,7	12,5	15,3	16,7	18,1	19,4	20,8	22,2
			l/min	0	583	750	917	1000	1083	1167	1250	1333
			mc/h	0	35	45	55	60	65	70	75	80
FB6SX60/17 + 6F40*	40	30	H(m)	229	183	156	141	134	124	110	94	79
FB6SX60/18 + 6F50*	50	37		243	196	167	150	143	133	118	102	85
FB6SX60/19 + 6F50*	50	37		256	205	175	158	150	140	124	106	89
FB6SX60/20 + 6F50*	50	37		269	215	184	165	157	146	129	111	92
FB6SX60/21 + 6F50*	50	37		281	225	192	173	164	152	134	115	96
FB6SX60/22 + 6F60*	60	45		298	239	204	184	175	163	144	124	104
FB6SX60/23 + 6F60*	60	45		311	249	213	191	182	170	150	129	108
FB6SX60/24 + 6F60*	60	45		323	259	221	199	189	176	155	133	112
FB6SX60/25 + 6F60*	60	45		336	268	229	206	196	182	161	138	115
FB6SX60/26 + 6F60*	60	45		348	278	237	214	203	188	166	142	118
FB6SX60/27 + 8F75*	75	55		373	303	259	233	222	209	186	162	138
FB6SX60/28 + 8F75*	75	55		386	314	268	242	229	216	193	167	142
FB6SX60/29 + 8F75*	75	55		399	324	277	250	237	223	199	172	146
FB6SX60/30 + 8F75*	75	55		413	335	286	258	245	230	205	177	151
FB6SX60/31 + 8F75*	75	55		426	345	295	266	252	237	211	183	155

Dimensioni e pesi

Overall dimensions and weights - Dimensions d'encombrement et poids

Tipo Type Type	Cv Hp	kW	A (mm)	B (mm)	C (mm)	D (mm)	ø max (mm)	DN	Peso - Weight - Poids					
									A (kg)	B (kg)	C (kg)			
									FB6SX60/17 + 6F40*	40	30	3467	2300	1167
FB6SX60/18 + 6F50*	50	37	3711	2414	1297	171	55	116						
FB6SX60/19 + 6F50*	50	37	3825	2528	1297	174	58	116						
FB6SX60/20 + 6F50*	50	37	3939	2642	1297	177	61	116						
FB6SX60/21 + 6F50*	50	37	4052	2755	1297	179	63	116						
FB6SX60/22 + 6F60*	60	45	4296	2969	1327	187	66	121						
FB6SX60/23 + 6F60*	60	45	4410	3083	1327	190	69	121						
FB6SX60/24 + 6F60*	60	45	4524	3197	1327	192	71	121						
FB6SX60/25 + 6F60*	60	45	4638	3311	1327	195	74	121						
FB6SX60/26 + 6F60*	60	45	4751	3424	1327	197	76	121						
FB6SX60/27 + 8F75*	75	55	4887	3538	1349	192	192	G 3"	267	83	184			
FB6SX60/28 + 8F75*	75	55	5001	3652	1349				269	85	184			
FB6SX60/29 + 8F75*	75	55	5114	3766	1349				272	88	184			
FB6SX60/30 + 8F75*	75	55	5228	3880	1349				274	90	184			
FB6SX60/31 + 8F75*	75	55	5342	3994	1349				277	93	184			



* Non consigliata per montaggio in posizione orizzontale

* This electropump isn't recommended for horizontal assemblage

* Cette électropompe n'est pas recommandée pour le montage en position horizontale

CURVE DELLE PRESTAZIONI

PERFORMANCES' CURVES

COURBES DES PERFORMANCES

FB6SX60

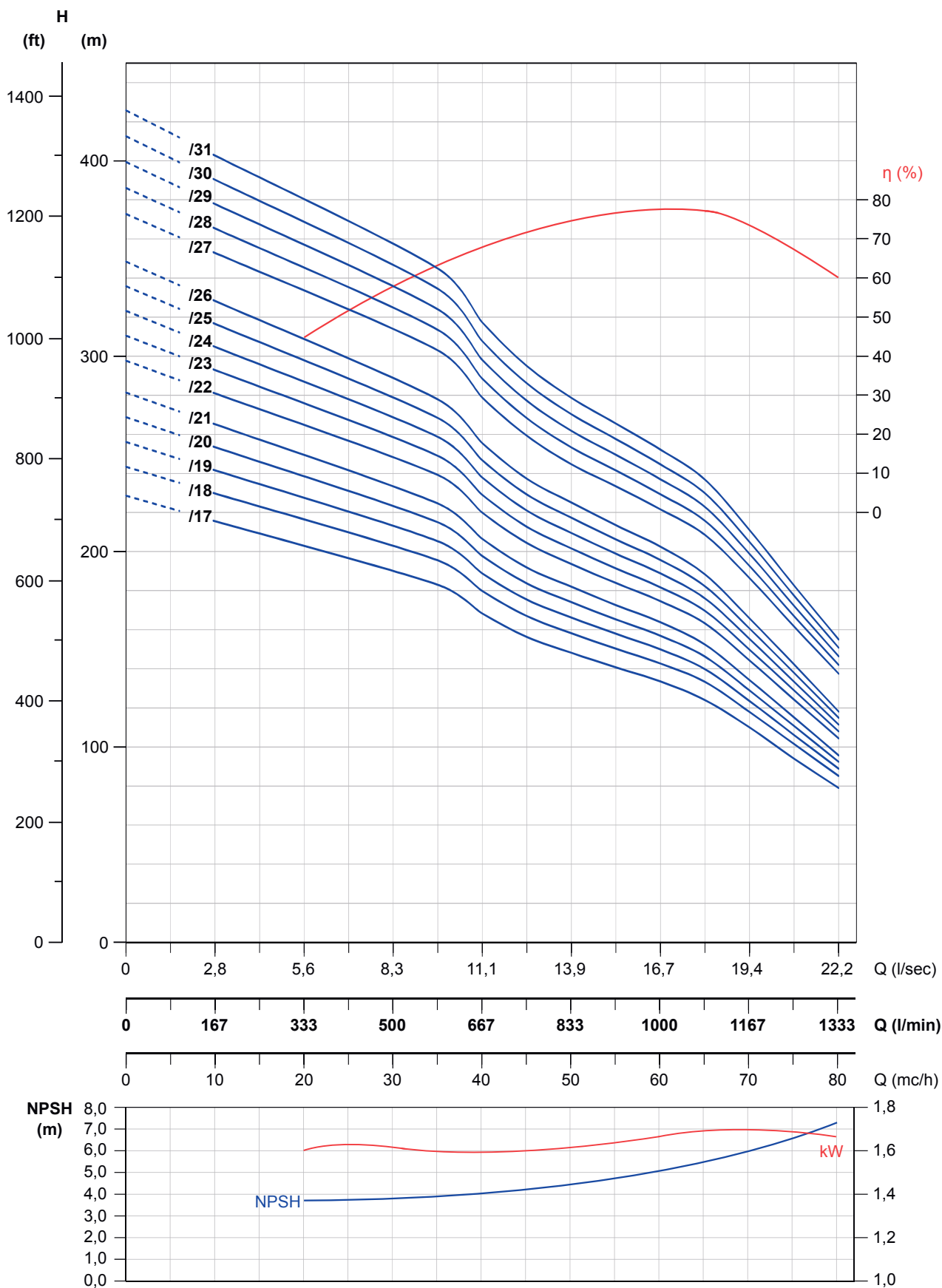
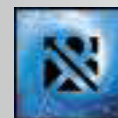

Tolleranze secondo EN ISO 9906 app.A Gr.2 - Tolerances according to EN ISO 9906 anx.A Gr.2 - Tolérances conformes EN ISO 9906 ann.A Gr.2
 Rispetta il Reg. UE n° 547/2012 con MEI = 0.40 - Comply with Reg. UE n° 547/2012 with MEI = 0.40 - Conforme Reg. UE n°547/2012 avec MEI =0.40

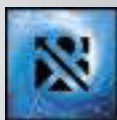

ELETTROPOMPE SOMMERSE 8" RADIALI IN GHISA

8" CAST IRON RADIAL-FLOW SUBMERSIBLE ELECTROPUMPS

ÉLECTROPOMPES IMMERGÉES 8" RADIALES EN FONTE



I corpi pompa 8" di tipo radiale in ghisa, serie FB8R, sono per acque pulite per pozzi 8" DN 200.

La particolarità delle pompe di tipo radiale è la costruzione a stadi di limitato ingombro assiale, tale particolarità consente di ottenere prevalenze elevate con portate medio - basse.

La robustezza di questa serie è data anche dalla costruzione delle giranti in ghisa, che consente l'installazione della pompa in pozzi profondi garantendo massima sicurezza dell'impianto e generando elevati rendimenti.

APPLICAZIONI:

- irrigazione
- approvvigionamento idrico
- aumento pressione
- antincendio

COSTRUZIONE:

- giranti in ghisa G25
- corpo di stadio in ghisa G25
- bocca di mandata in ghisa G25
- valvola di ritegno in ghisa G25
- albero in acciaio inox AISI 420
- proteggi cavo in acciaio inox AISI 304
- griglia d'aspirazione in acciaio inox AISI 304
- viteria in acciaio inox AISI 304

CARATTERISTICHE:

- portata massima: 1333 l/m
- prevalenza massima: 858 metri
- potenza massima: 92 kW
- diametro d'ingombro massimo: 198 mm (incluso il copri cavo)
- temperatura massima dell'acqua: 60°C (solo per corpo pompa, per il motore vedi catalogo motori)
- contenuto di sabbia massimo: 30 g/m³

OPTIONAL:

Su richiesta si possono fornire corpi pompa in ghisa:

- con giranti in bronzo GCuSn10 (B10)
- con giranti in acciaio inox AISI 316



8" cast iron radial - flow pumps, range FB8R, are for clean water for 8" wells DN 200.

The peculiarity of the radial - flow pumps is the stage construction with limited axial dimension, this peculiarity allows to reach high head with small and medium capacity.

The sturdiness of this range is given by the cast iron impellers, they permit the installation of the pump in deep wells granting the maximum safety to the system and producing high performances.

APPLICATIONS:

- irrigation
- water supply system
- pressure boosting
- fire-fighting systems

CONSTRUCTION:

- cast iron G25 impellers
- cast iron G25 delivery bowl
- cast iron G25 pump body
- cast iron G25 non-return valve
- stainless steel AISI 420 shaft
- stainless steel AISI 304 cable cover
- stainless steel AISI 304 suction strainer
- stainless steel AISI 304 nuts, bolts and screws

FEATURES:

- maximum capacity: 1333 l/m
- maximum head: 858 meters
- maximum power: 92 kW
- maximum encumbrance diameter: 198 mm (cable cover included)
- maximum water temperature: 60°C (only for the pump, for the motor see motors' catalogue)
- maximum sand content: 30 g/m³

OPTIONAL:

On demand cast iron pumps can be manufactured with:

- bronze GCuSn10 (B10) impellers
- stainless steel AISI 316 impellers

ELETTROPOMPE SOMMERSE 8" RADIALI IN GHISA

8" CAST IRON RADIAL-FLOW SUBMERSIBLE ELECTROPUMPS

ÉLECTROPOMPES IMMERGÉES 8" RADIALES EN FONTE

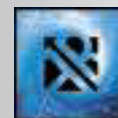

Les pompes immergées 8" du type radiale en fonte, série FB8R, sont pour eaux propres pour puits de 8" DN 200.

La particularité des pompes du type radiale est la construction par des stades d'encombrement axial limité, il permet d'obtenir des hauteurs élevées avec des bas et moyens débits.

La solidité de cette gamme de pompes est donnée par la construction des roues en fonte, qui permet l'installation de la pompe dans puits profonds en garantissant sûreté maximale de l'installation et en engendrant hautes performances.

APPLICATIONS:

- irrigation
- installation d'approvisionnement hydrique
- surpression
- anti incendie

CONSTRUCTION:

- roues en fonte G25
- corps d'étage en fonte G25
- orifice de refoulement en fonte G25
- crépine de non-retour en fonte G25
- arbre en acier inoxydable AISI 420
- couvre-câble en acier inoxydable AISI 304
- crépine d'aspiration en acier inoxydable AISI 304
- visserie en acier inoxydable AISI 304

CARACTÉRISTIQUES:

- débit maximum: 1333 l/m
- hauteur maximale: 858 mètres
- puissance maximale: 92 Kw
- diamètre d'encombrement maximum: 198 mm (inclus le couvre-câble)
- température maximale de l'eau: 60°C (pour la pompe, pour le moteur voir le catalogue des moteurs)
- quantité maximale de sable: 30 g/m³

OPTIONAL:

Sur demande on peut fournir pompes en fonte:

- avec roues en bronze GCuSn10 (B10)
- avec roues en acier inoxydable AISI 316



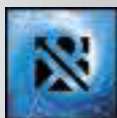

ELETTROPOMPE SOMMERSE 8" RADIALI IN BRONZO

8" BRONZE RADIAL-FLOW SUBMERSIBLE ELECTROPUMPS

ÉLECTROPOMPES IMMERGÉES 8" RADIALES EN BRONZE



APPLICAZIONI:

- irrigazione, approvvigionamento idrico, aumento pressione ed antincendio
- acqua di mare
- acqua salmastre

COSTRUZIONE:

- girante in bronzo GCuSn10 (B10)
- corpo di stadio in bronzo GCuSn10 (B10)
- bocca di mandata in bronzo GCuSn10 (B10)
- valvola di ritegno in bronzo GCuSn10 (B10)
- albero in acciaio inox AISI 316
- copri cavo in acciaio inox AISI 316
- griglia d'aspirazione in acciaio inox AISI 316
- viteria in acciaio inox AISI 316

CARATTERISTICHE:

- portata massima: 1333 l/m
- prevalenza massima: 858 metri
- potenza massima: 92 kW
- diametro d'ingombro massimo: 198 mm (incluso il copri cavo)
- temperatura massima dell'acqua: 60°C (solo per corpo pompa, per il motore vedi catalogo motori)
- contenuto di sabbia massimo: 30 g/m³



APPLICATIONS:

- irrigation, water supply system, pressure boosting and fire-fighting systems
- sea water
- brackish water

CONSTRUCTION:

- bronze GCuSn10 (B10) impellers
- bronze GCuSn10 (B10) delivery bowl
- bronze GCuSn10 (B10) pump body
- bronze GCuSn10 (B10) non-return valve
- stainless steel AISI 316 shaft
- stainless steel AISI 316 cable cover
- stainless steel AISI 316 suction strainer
- stainless steel AISI 316 nuts, bolts and screws

FEATURES:

- maximum capacity: 1333 l/m
- maximum head: 858 meters
- maximum power: 92 kW
- maximum encumbrance diameter: 198 mm (cable cover included)
- maximum water temperature: 60°C (only for the pump, for the motor see motors' catalogue)
- maximum sand content: 30 g/m³



APPLICATIONS:

- irrigation, installation d'approvisionnement hydrique, surpression et anti incendie
- eau de mer
- eau saumâtre

CONSTRUCTION:

- roues en bronze GCuSn10 (B10)
- corps d'étage en bronze GCuSn10 (B10)
- orifice de refoulement bronze GCuSn10 (B10)
- crépine de non-retour en bronze GCuSn10 (B10)
- arbre en acier inoxydable AISI 316
- couvre-câble en acier inoxydable AISI 316
- crépine d'aspiration en acier inoxydable AISI 316
- visserie en acier inoxydable AISI 316

CARACTERISTIQUES:

- débit maximum: 1333 l/m
- hauteur maximale: 858 mètres
- puissance maximale: 92 Kw
- diamètre d'encombrement maximum: 198 mm (inclus le couvre-câble)
- température maximale de l'eau: 60°C (pour la pompe, pour le moteur voir le catalogue des moteurs)
- quantité maximale de sable: 30 g/m³



SPACCATO 8"

8" CUTAWAY
COUPE 8"

FB8R

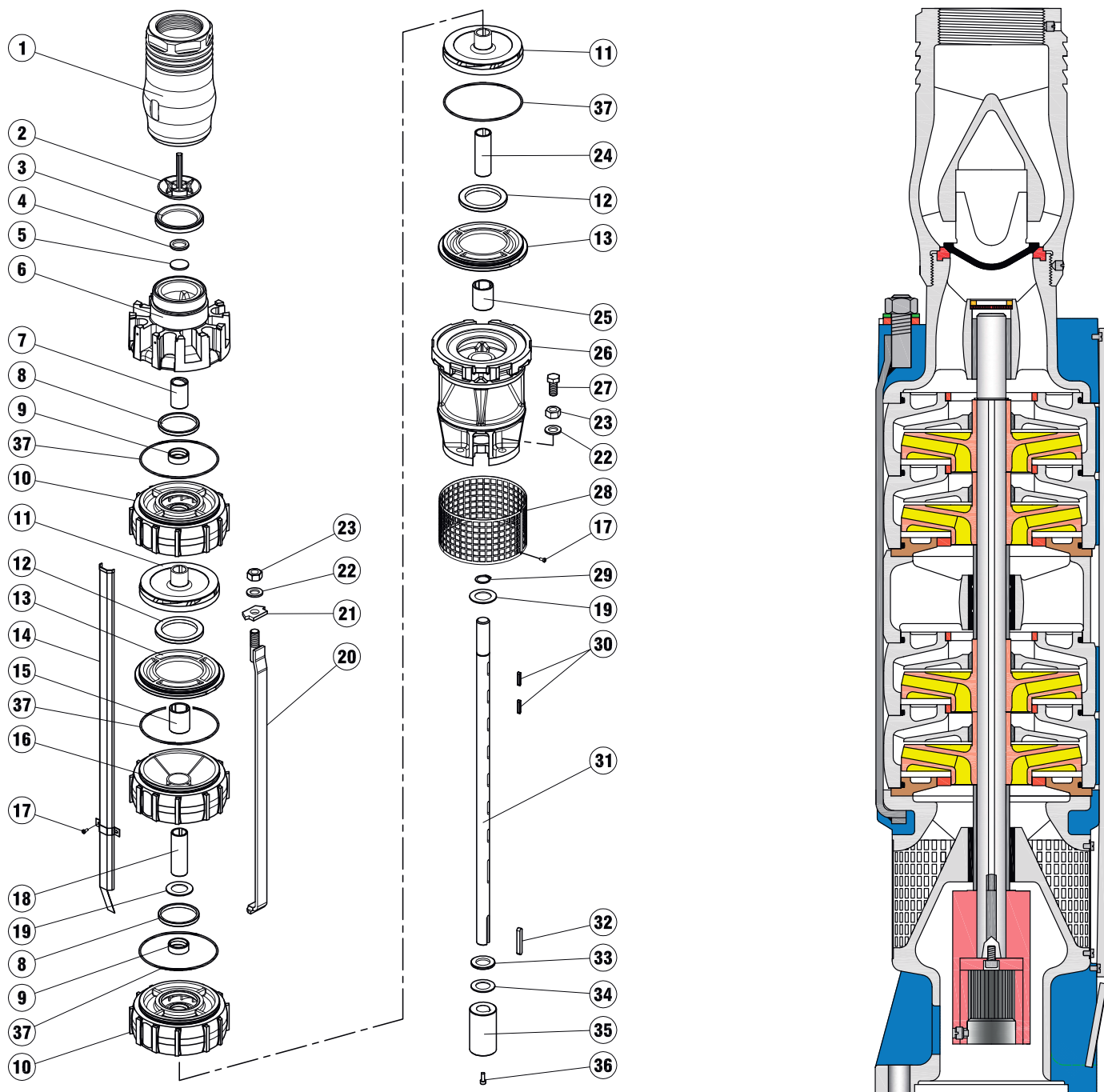
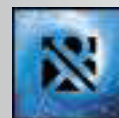

Pos.	Qt.	Denominazione	Denomination	Denomination
1	1	Corpo della valvola	Valve body	Corps de clapet
2	1	Otturatore della valvola	Wing valve	Soupape du clapet
3	1	Sede valvola	Valve seat	Siège de soupape
4	1	Anello di fermo	Circlip	Segment d'arrêt
5	1	Filtro di sfiato	Vent filter	Filtre de purge d'air
6	1	Camera premente	Discharge casing	Corps de refoulement
7	1	Cuscinetto a boccia	Bearing bush	Coussinet, côté refoul.
8	1	Anello di usura fisso	Casing wear ring	Bague d'usure
9	1	Bussola distanziale	Interstage bush	Douille entre étages
10	*N	Corpo di stadio	Stage casing	Corps d'étage
11	*N	Girante	Impeller	Roue
12	1-2	Anello di usura fisso	Casing wear ring	Bague d'usure
13	1-2	Anello di centraggio	Centring ring	Bague de centrage
14	1	Tegolo protezione cavo	Cable guard	Protège-cable
15	1-2	Cuscinetto a boccia	Bearing bush	Coussinet
16	1-2	Supporto intermedio	Intermediate bearing	Palier intermédiaire
17	6-10	Vite	Screw	Vis
18	1	Camicia d'albero	Intern. bearing sleeve	Chemise arbre intern.
19	1	Rondella di compens.	Compensating washer	Rondelle de compens.

Pos.	Qt.	Denominazione	Denomination	Denomination
20	6	Tirante del corpo	Tie bolt	Tirant d'assemblage
21	6	Piastrina per tirante	Pressure plate	Rondelle spéciale
22	6	Rosetta	Washer	Rondelle
23	6	Dado	Nut	Ecrou
24	1	Bussola distanziale	Bearing sleeve	Chemise d'arbre
25	1	Cuscinetto a boccia	Bearing bush	Coussinet
26	1	Camera aspirante	Suction casing	Corps d'aspiration
27	1	Vite	Screw	Vis
28	1	Griglia d'aspirazione	Suction strainer	Crépine d'aspiration
29	1	Anello di fermo	Circlip for shaft	Segment d'arrêt
30	*N	Linguetta girante	Key for impeller	Clavette de la roue
31	1	Albero pompa	Pump shaft	Arbre de pompe
32	1	Linguetta giunto	Key for coupling	Clavette pour accoupl.
33	1	Anello contosp. fisso	Counter ring	Grain fixe de contre
34	1	Anello contosp. mobile	Counter ring	Grain fixe de contre
35	1	Giunto	Coupling	Accouplement
36	1	Vite	Screw	Vis
37	*N+1	Guarnizione corpo	Joint for stage casing	Joint du corps d'étage

*N=Numero di scatole e giranti variabili dal tipo di pompa

*N=The number of the boxer and the impellers vary according to the type of the pump.

*N=Numéro d'enveloppes et roues selon le type de pompe.



TABELLA DELLE CARATTERISTICHE IDRAULICHE 8"

8" HYDRAULIC FEATURES' CHART

TABLE DES CARACTÉRISTIQUES HYDRAULIQUES 8"

Tipo Type Type	Motore Motor Moteur		Q = Portata - Capacity - Débit																		
			l/sec	0	2,8	4,2	5,6	7	8,3	9,7	11,1	12,5	13,9	16,7	19,5	22,2					
	l/min	0	167	250	333	417	500	583	667	750	833	1000	1167	1333							
	Hp	Kw	mc/h	0	10	15	20	25	30	35	40	45	50	60	70	80					
FB8RA/2	7,5	5,5		50	47	46	45	42	39	36	30	22									
FB8RA/3	12,5	9,2		76	73	71	68	65	60	54	46	34									
FB8RA/4	15	11		102	99	96	92	87	81	73	62	46									
FB8RA/5	17,5	13		129	124	121	116	110	102	93	78	58									
FB8RA/6	25	18,5		156	151	146	141	133	124	112	95	71									
FB8RA/7	25	18,5		182	178	175	165	155	144	131	111	83									
FB8RA/8	30	22		208	200	195	188	178	165	150	127	94									
FB8RA/9	35	26		235	226	220	212	200	186	168	143	106									
FB8RA/10	35	26		261	251	244	235	222	206	187	159	118									
FB8RA/11	40	30		287	275	268	259	244	227	206	174	130									
FB8RA/12	50	37		313	301	293	282	266	247	224	190	142									
FB8RA/13	50	37		339	326	317	306	289	268	243	206	153									
FB8RA/14	50	37		365	351	342	329	311	289	262	222	165									
FB8RA/15	60	45		391	377	366	353	333	309	281	238	177									
FB8RA/16	60	45		417	402	390	376	355	330	299	254	189									
FB8RA/17	60	45	H(m)	443	426	415	400	377	351	318	269	201									
FB8RA/18	70	51		469	452	439	423	400	371	337	285	212									
FB8RA/19	70	51		494	475	465	446	426	391	353	300	220									
FB8RA/20	75	55		521	502	488	470	444	412	374	317	236									
FB8RA/21	75	55		547	525	512	494	466	433	393	333	248									
FB8RA/22	80	59		572	550	539	517	490	455	411	349	259									
FB8RA/23	85	62		598	577	564	541	512	476	430	365	271									
FB8RA/24	85	62		624	602	588	564	535	496	448	381	283									
FB8RA/25	90	66		650	628	613	588	557	517	467	397	294									
FB8RA/26	100	75		676	653	637	611	579	538	486	412	306									
FB8RA/27	100	75		702	678	662	635	601	558	504	428	318									
FB8RA/28	100	75		728	703	686	658	624	579	523	444	330									
FB8RA/29	125	92		754	728	711	682	646	600	542	460	341									
FB8RA/30	125	92		780	753	735	705	668	620	560	476	353									
FB8RA/31	125	92		806	778	760	729	690	641	579	492	365									
FB8RA/32	125	92		832	803	784	752	713	662	598	508	377									
FB8RA/33	125	92		858	828	809	776	735	683	617	524	389									

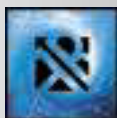
TABELLA DELLE CARATTERISTICHE IDRAULICHE 8"

8" HYDRAULIC FEATURES' CHART

TABLE DES CARACTÉRISTIQUES HYDRAULIQUES 8"

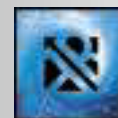

n=2900 1/min 50 Hz

Tipo Type Type	Motore Motor Moteur		Q = Portata - Capacity - Débit																		
			l/sec	0	2,8	4,2	5,6	7	8,3	9,7	11,1	12,5	13,9	16,7	19,5	22,2					
	l/min	0	167	250	333	417	500	583	667	750	833	1000	1167	1333							
	Hp	Kw	mc/h	0	10	15	20	25	30	35	40	45	50	60	70	80					
FB8RB/2	10	7,5		47				42	41	40	39	37	35	31	25	17					
FB8RB/3	15	11		72				65	63	61	59	57	54	47	38	27					
FB8RB/4	20	15		97				87	85	82	80	77	73	63	51	36					
FB8RB/5	25	18,5		122				110	107	104	101	97	92	80	65	46					
FB8RB/6	30	22		148				134	130	126	122	118	112	97	79	55					
FB8RB/7	35	26		173				156	152	147	143	138	130	113	92	64					
FB8RB/8	40	30		198				178	174	168	163	158	149	129	105	74					
FB8RB/9	50	37		224				201	195	188	184	176	167	145	117	83					
FB8RB/10	50	37		247				223	217	210	204	197	186	161	131	92					
FB8RB/11	60	45		274				244	239	231	224	215	205	177	143	101					
FB8RB/12	60	45		296				268	260	252	245	236	223	193	157	110					
FB8RB/13	70	51	H(m)	324				290	282	273	265	256	242	209	169	120					
FB8RB/14	70	51		350				312	304	294	286	276	260	224	182	127					
FB8RB/15	75	55		371				335	326	315	306	296	279	242	197	138					
FB8RB/16	80	59		400				357	346	336	326	315	298	258	208	144					
FB8RB/17	85	62		420				379	369	357	347	335	316	274	223	156					
FB8RB/18	90	66		450				401	389	378	367	356	335	290	234	164					
FB8RB/19	100	75		473				425	412	400	388	370	353	306	247	175					
FB8RB/20	100	75		494				446	434	420	408	394	372	322	262	184					
FB8RB/21	125	92		523				468	456	442	428	412	391	338	273	193					
FB8RB/22	125	92		548				491	477	461	449	429	409	354	286	202					
FB8RB/23	125	92		573				511	499	484	469	450	428	370	299	212					
FB8RB/25	125	92		625				560	543	528	510	488	465	403	325	230					

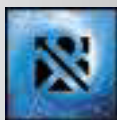

Tipo Type Type	Motore Motors 2900 g/m Moteurs		Q = Portata - Capacity - Débit									
	Cv Hp	Kw	l/sec	0	2,8	4,2	5,6	7	8,3	9,7	11,1	12,5
			l/min	0	167	250	333	417	500	583	667	750
	mc/h	0	10	15	20	25	30	35	40	45		
FB8RA/2 + 6F7	7,5	5,5	50	47	46	45	42	39	36	30	22	
FB8RA/3 + 6F12	12,5	9,2	76	73	71	68	65	60	54	46	34	
FB8RA/4 + 6F15	15	11	102	99	96	92	87	81	73	62	46	
FB8RA/5 + 6F17	17,5	13	129	124	121	116	110	102	93	78	58	
FB8RA/6 + 6F25	25	18,5	156	151	146	141	133	124	112	95	71	
FB8RA/7 + 6F25	25	18,5	182	178	175	165	155	144	131	111	83	
FB8RA/8 + 6F30	30	22	208	200	195	188	178	165	150	127	94	
FB8RA/9 + 6F35	35	26	235	226	220	212	200	186	168	143	106	
FB8RA/10 + 6F35	35	26	261	251	244	235	222	206	187	159	118	
FB8RA/11 + 8F40	40	30	287	275	268	259	244	227	206	174	130	
FB8RA/12 + 8F50	50	37	313	301	293	282	266	247	224	190	142	
FB8RA/13 + 8F50	50	37	339	326	317	306	289	268	243	206	153	
FB8RA/14 + 8F50	50	37	365	351	342	329	311	289	262	222	165	
FB8RA/15 + 8F60	60	45	391	377	366	353	333	309	281	238	177	
FB8RA/16 + 8F60	60	45	417	402	390	376	355	330	299	254	189	
FB8RA/17 + 8F60	60	45	443	426	415	400	377	351	318	269	201	
FB8RA/18 + 8F70	70	51	469	452	439	423	400	371	337	285	212	
FB8RA/19 + 8F70	70	51	494	475	465	446	426	391	353	300	220	
FB8RA/20 + 8F75	75	55	521	502	488	470	444	412	374	317	236	
FB8RA/21 + 8F75	75	55	547	525	512	494	466	433	393	333	248	
FB8RA/22 + 8F80	80	59	572	550	539	517	490	455	411	349	259	
FB8RA/23 + 8F85	85	62	598	577	564	541	512	476	430	365	271	
FB8RA/24 + 8F85*	85	62	624	602	588	564	535	496	448	381	283	
FB8RA/25 + 8F90*	90	66	650	628	613	588	557	517	467	397	294	
FB8RA/26 + 8F100*	100	75	676	653	637	611	579	538	486	412	306	
FB8RA/27 + 8F100*	100	75	702	678	662	635	601	558	504	428	318	
FB8RA/28 + 8F100*	100	75	728	703	686	658	624	579	523	444	330	
FB8RA/29 + 8F125*	125	92	754	728	711	682	646	600	542	460	341	
FB8RA/30 + 8F125*	125	92	780	753	735	705	668	620	560	476	353	
FB8RA/31 + 8F125*	125	92	806	778	760	729	690	641	579	492	365	
FB8RA/32 + 8F125*	125	92	832	803	784	752	713	662	598	508	377	
FB8RA/33 + 8F125*	125	92	858	828	809	776	735	683	617	524	389	

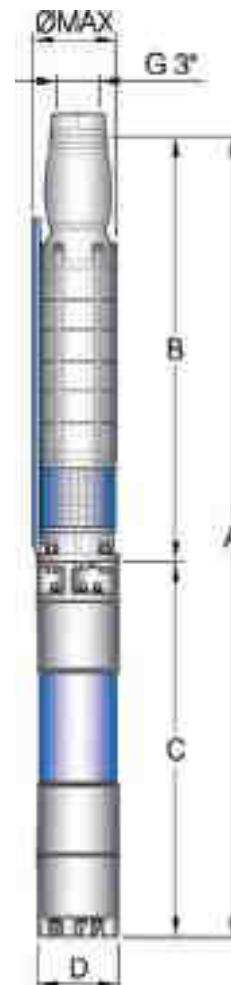

Dimensioni e pesi

Overall dimensions and weights - Dimensions d'encombrement et poids

Tipo Type Type	Cv Hp	Kw	A (mm)	B (mm)	C (mm)	D (mm)	ø max (mm)	DN	Peso - Weight - Poids			
									A (kg)	B (kg)	C (kg)	
FB8RA/2 + 6F7	7,5	5,5	1297	670	627	145		198	G 3"	93	47	46
FB8RA/3 + 6F12	12,5	9,2	1427	730	697					107	53	54
FB8RA/4 + 6F15	15	11	1557	790	767					120	59	61
FB8RA/5 + 6F17	17,5	13	1617	850	767					127	65	62
FB8RA/6 + 6F25	25	18,5	1807	910	897					146	71	75
FB8RA/7 + 6F25	25	18,5	1867	970	897					152	77	75
FB8RA/8 + 6F30	30	22	1997	1030	967					165	83	82
FB8RA/9 + 6F35	35	26	2117	1090	1027					178	89	89
FB8RA/10 + 6F35	35	26	2177	1150	1027					184	95	89
FB8RA/11 + 8F40	40	30	2365	1316	1049					248	110	138
FB8RA/12 + 8F50	50	37	2495	1376	1119					269	116	153
FB8RA/13 + 8F50	50	37	2555	1436	1119					275	122	153
FB8RA/14 + 8F50	50	37	2615	1496	1119					281	128	153
FB8RA/15 + 8F60	60	45	2785	1556	1229					305	134	171
FB8RA/16 + 8F60	60	45	2845	1616	1229	311	140	171				
FB8RA/17 + 8F60	60	45	2905	1676	1229	317	146	171				
FB8RA/18 + 8F70	70	51	2965	1736	1229	324	152	172				
FB8RA/19 + 8F70	70	51	3025	1796	1229	330	158	172				
FB8RA/20 + 8F75	75	55	3205	1856	1349	348	164	184				
FB8RA/21 + 8F75	75	55	3343	1994	1349	359	175	184				
FB8RA/22 + 8F80	80	59	3403	2054	1349	365	181	184				
FB8RA/23 + 8F85	85	62	3463	2114	1349	371	187	184				
FB8RA/24 + 8F85*	85	62	3523	2174	1349	377	193	184				
FB8RA/25 + 8F90*	90	66	3653	2234	1419	404	199	205				
FB8RA/26 + 8F100*	100	75	3903	2294	1609	441	205	236				
FB8RA/27 + 8F100*	100	75	3963	2354	1609	447	211	236				
FB8RA/28 + 8F100*	100	75	4023	2414	1609	453	217	236				
FB8RA/29 + 8F125*	125	92	4153	2474	1679	461	223	238				
FB8RA/30 + 8F125*	125	92	4213	2534	1679	467	229	238				
FB8RA/31 + 8F125*	125	92	4273	2594	1679	473	235	238				
FB8RA/32 + 8F125*	125	92	4333	2654	1679	479	241	238				
FB8RA/33 + 8F125*	125	92	4393	2714	1679	485	247	238				

* Non consigliata per montaggio in posizione orizzontale
 * This electropump isn't recommended for horizontal assemblage
 * Cette électropompe n'est pas recommandée pour le montage en position horizontale

CURVE DELLE PRESTAZIONI

PERFORMANCES' CURVES

COURBES DES PERFORMANCES

FB8RA

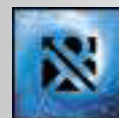

n=2900 1/min 50 Hz

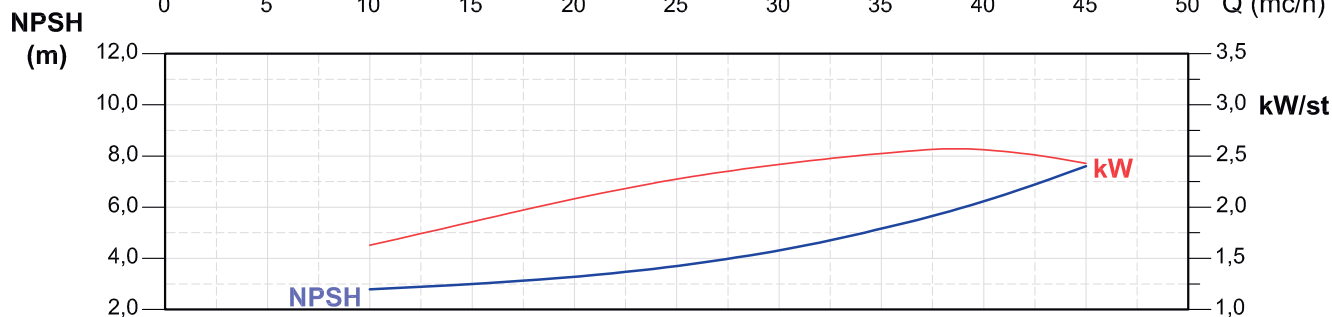
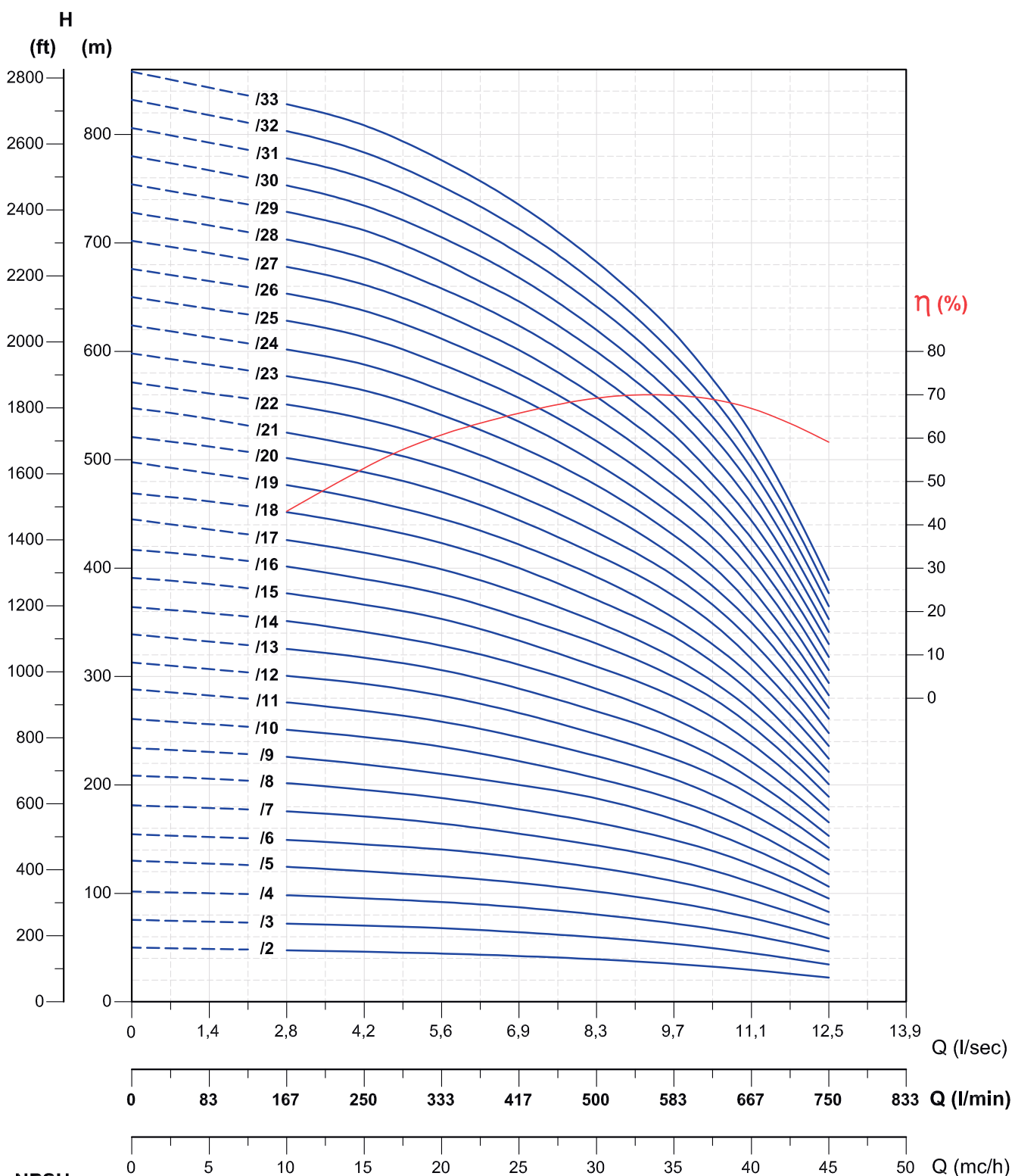

Tolleranze secondo EN ISO 9906 app.A Gr.2 - Tolerances according to EN ISO 9906 anx.A Gr.2 - Tolérances conformes EN ISO 9906 ann.A Gr.2

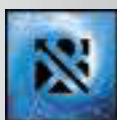

Tipo Type Type	Motore Motors 2900 g/m Moteurs		Q = Portata - Capacity - Débit									
	Cv Hp	Kw	l/sec	0	2,8	5,6	8,3	11,1	13,9	16,7	19,5	22,2
			l/min	0	167	333	500	667	833	1000	1167	1333
			mc/h	0	10	20	30	40	50	60	70	80
FB8RB/2 + 6F10	10	7,5	H(m)	47	45	43	41	39	35	31	25	17
FB8RB/3 + 6F15	15	11		72	69	66	63	59	54	47	38	27
FB8RB/4 + 6F20	20	15		97	94	90	85	80	73	63	51	36
FB8RB/5 + 6F25	25	18,5		122	118	113	107	101	92	80	65	46
FB8RB/6 + 6F30	30	22		148	143	137	130	122	112	97	79	55
FB8RB/7 + 6F35	35	26		173	167	160	152	143	130	113	92	64
FB8RB/8 + 8F40	40	30		198	191	183	174	163	149	129	105	74
FB8RB/9 + 8F50	50	37		224	214	205	195	184	167	145	117	83
FB8RB/10 + 8F50	50	37		247	239	229	217	204	186	161	131	92
FB8RB/11 + 8F60	60	45		274	262	251	239	224	205	177	143	101
FB8RB/12 + 8F60	60	45		296	286	274	260	245	223	193	157	110
FB8RB/13 + 8F70	70	51		324	309	296	282	265	242	209	169	120
FB8RB/14 + 8F70	70	51		350	335	319	304	286	260	224	182	127
FB8RB/15 + 8F75	75	55		371	358	343	326	306	279	242	197	138
FB8RB/16 + 8F80	80	59		400	384	365	346	326	298	258	208	144
FB8RB/17 + 8F85	85	62		420	405	388	369	347	316	274	223	156
FB8RB/18 + 8F90*	90	66		450	430	410	389	367	335	290	234	164
FB8RB/19 + 8F100*	100	75		473	455	433	412	388	353	306	247	175
FB8RB/20 + 8F100*	100	75		494	477	457	434	408	372	322	262	184
FB8RB/21 + 8F125*	125	92		523	500	479	456	428	391	338	273	193
FB8RB/22 + 8F125*	125	92		548	524	502	477	449	409	354	286	202
FB8RB/23 + 8F125*	125	92		573	547	524	499	469	428	370	299	212
FB8RB/25 + 8F125*	125	92		625	598	570	543	510	465	403	325	230

Dimensioni e pesi

Overall dimensions and weights - Dimensions d'encombrement et poids

Tipo Type Type	Cv Hp	Kw	A (mm)	B (mm)	C (mm)	D (mm)	ø max (mm)	DN	Peso - Weight - Poids		
									A (kg)	B (kg)	C (kg)
									FB8RB/2 + 6F10	10	7,5
FB8RB/3 + 6F15	15	11	1497	730	767	114	53	61			
FB8RB/4 + 6F20	20	15	1617	790	827	127	59	68			
FB8RB/5 + 6F25	25	18,5	1747	850	897	140	65	75			
FB8RB/6 + 6F30	30	22	1877	910	967	153	71	82			
FB8RB/7 + 6F35	35	26	1997	970	1027	166	77	89			
FB8RB/8 + 8F40	40	30	2107	1058	1049	225	87	138			
FB8RB/9 + 8F50	50	37	2237	1118	1119	246	93	153			
FB8RB/10 + 8F50	50	37	2297	1178	1119	252	99	153			
FB8RB/11 + 8F60	60	45	2545	1316	1229	281	110	171			
FB8RB/12 + 8F60	60	45	2605	1376	1229	287	116	171			
FB8RB/13 + 8F70	70	51	2665	1436	1229	294	122	172			
FB8RB/14 + 8F70	70	51	2725	1496	1229	300	128	172			
FB8RB/15 + 8F75	75	55	2905	1556	1349	318	134	184			
FB8RB/16 + 8F80	80	59	2965	1616	1349	324	140	184			
FB8RB/17 + 8F85	85	62	3025	1676	1349	330	146	184			
FB8RB/18 + 8F90*	90	66	3155	1736	1419	357	152	205			
FB8RB/19 + 8F100*	100	75	3405	1796	1609	394	158	236			
FB8RB/20 + 8F100*	100	75	3465	1856	1609	400	164	236			
FB8RB/21 + 8F125*	125	92	3673	1994	1679	413	175	238			
FB8RB/22 + 8F125*	125	92	3733	2054	1679	419	181	238			
FB8RB/23 + 8F125*	125	92	3793	2114	1679	425	187	238			
FB8RB/25 + 8F125*	125	92	3913	2234	1679	437	199	238			

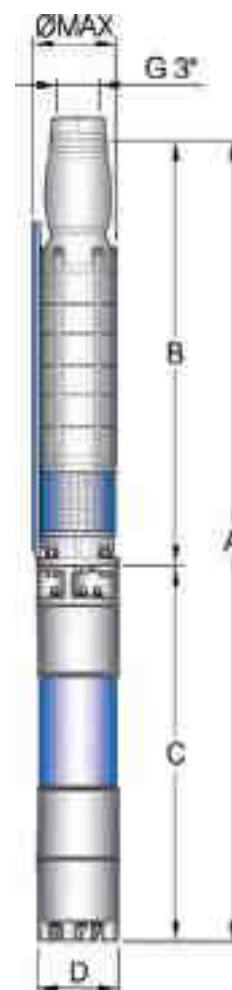

* Non consigliata per montaggio in posizione orizzontale

* This electropump isn't recommended for horizontal assemblage

* Cette électropompe n'est pas recommandée pour le montage en position horizontale

CURVE DELLE PRESTAZIONI

PERFORMANCES' CURVES

COURBES DES PERFORMANCES

FB8RB

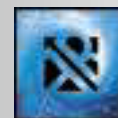

n=2900 1/min 50 Hz

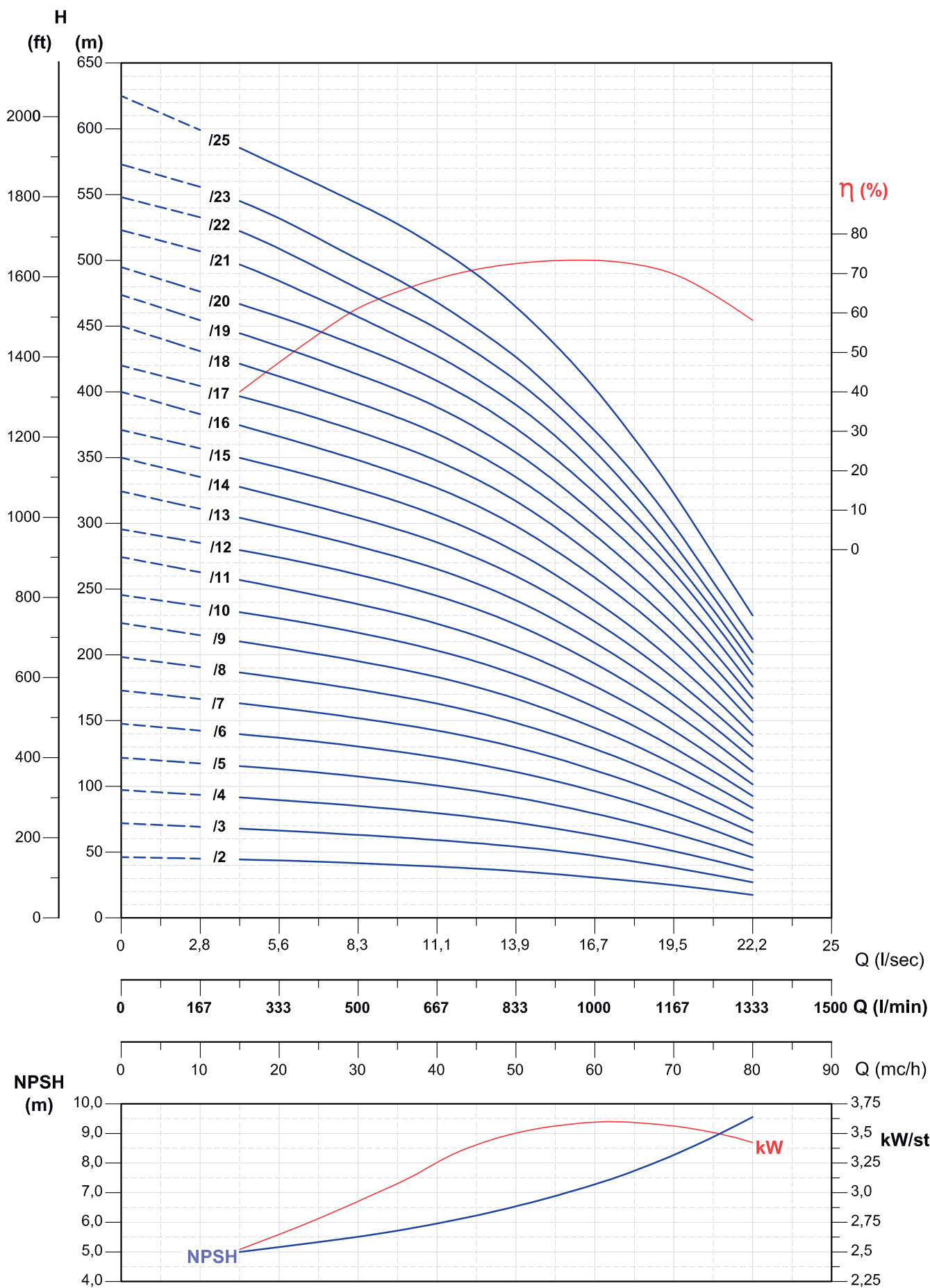

Tolleranze secondo EN ISO 9906 app.A Gr.2 - Tolerances according to EN ISO 9906 anx.A Gr.2 - Tolérances conformes EN ISO 9906 ann.A Gr.2

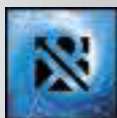

ELETTROPOMPE SOMMERSE 8" SEMIASSIALI IN GHISA

8" CAST IRON MIXED-FLOW SUBMERSIBLE ELECTROPUMPS

ÉLECTROPOMPES IMMERGÉES 8" SEMI-AXIALES EN FONTE



I corpi pompa 8" di tipo semiassiale in ghisa, serie FB8S, sono per acque pulite per pozzi 8" DN 200.

Questo tipo di pompa è costituito dalla presenza dei corpi di stadio con diffusore incorporato e dalle giranti semiassiali, questa tipologia è da preferire quando si ha necessità di avere elevate portate con prevalenze medio - basse.

APPLICAZIONI:

- irrigazione
- approvvigionamento idrico
- aumento pressione
- antincendio

CONSTRUZIONE:

- girante in ghisa G25
- corpo di stadio in ghisa G25
- bocca di mandata in ghisa G25
- valvola di ritegno in ghisa G25
- albero in acciaio inox AISI 420
- copri cavo in acciaio inox AISI 304
- griglia d'aspirazione in acciaio inox AISI 304
- viteria in acciaio inox AISI 304

CARATTERISTICHE:

- portata massima: 2667 l/m
- prevalenza massima: 384 metri
- potenza massima: 110 Kw
- diametro d'ingombro massimo: 198 mm (incluso il copri cavo)
- temperatura massima dell'acqua: 60°C (solo per corpo pompa, per il motore vedi catalogo motori)
- contenuto di sabbia massimo: 100 g/m³

OPTIONAL:

Su richiesta si possono fornire corpi pompa in ghisa:

- con sole giranti in bronzo GCuSn10 (B10)
- con sole giranti in acciaio inox AISI 316



8" pumps mixed-flow type, range FB8S, are for clean water for 8" wells DN 200. This pumps have mixed-flow impellers with diffusers combined on each stage. They may be chosen when high capacity and medium-low head are needed.

APPLICATIONS:

- irrigation
- water supply system
- pressure boosting
- fire-fighting systems

CONSTRUCTION:

- cast iron G25 impellers
- cast iron G25 delivery bowl
- cast iron G25 pump body
- cast iron G25 non-return valve
- stainless steel AISI 420 shaft
- stainless steel AISI 304 cable cover
- stainless steel AISI 304 suction strainer
- stainless steel AISI 304 nuts, bolts and screws

FEATURES:

- maximum capacity: 2667 l/m
- maximum head: 384 meters
- maximum power: 110 Kw
- maximum encumbrance diameter: 198 mm

(cable cover included)

- maximum water temperature: 60°C (only for the pump, for the motor see motors' catalogue)
- maximum sand content: 100 g/m³

OPTIONAL:

On demand cast iron pumps can be manufactured with:

- bronze GCuSn10 (B10) impellers
- stainless steel AISI 316 impellers



Les pompes 8" semi-axiales en fonte, série FB8S, sont pour eaux propres pour puits de 8" DN200.

Ces pompes sont caractérisées par la présence de stades avec le diffuseur incorporé et roues semi-axiales.

La gamme semi-axiale est à préférer quand il faut avoir hautes débits avec des moyennes et basses hauteurs.

APPLICATIONS:

- irrigation
- installation d'approvisionnement hydrique
- surpression
- anti incendie

CONSTRUCTION:

- roues en fonte G25
- corps d'étage en fonte G25
- orifice de refoulement en fonte G25
- crépine de non-retour en fonte G25
- arbre en acier inoxydable AISI 420
- couvre-câble en acier inoxydable AISI 304
- crépine d'aspiration en acier inoxydable AISI 304
- visserie en acier inoxydable AISI 304

CARACTÉRISTIQUES:

- débit maximum: 2667 l/m
- hauteur maximale: 384 mètres
- puissance maximale: 110 Kw
- diamètre d'encombrement maximum: 198 mm (inclus le couvre-câble)
- température maximale de l'eau: 60°C (pour la pompe, pour le moteur voir le catalogue des moteurs)
- quantité maximale de sable: 100 g/m³

OPTIONAL:

Sur demande on peut fournir pompes en fonte:

- avec roues en bronze GCuSn10 (B10)
- avec roues en acier inoxydable AISI 316



ELETTROPOMPE SOMMERSE 8" SEMIASSIALI IN BRONZO

8" BRONZE MIXED-FLOW SUBMERSIBLE ELECTROPUMPS

ÉLECTROPOMPES IMMERGÉES 8" SEMI-AXIALES EN BRONZE

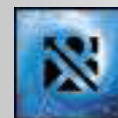

APPLICAZIONI:

- irrigazione, approvvigionamento idrico, aumento pressione ed antincendio
- acqua di mare
- acque salmastre

COSTRUZIONE:

- girante in bronzo GCuSn10 (B10)
- corpo di stadio in bronzo GCuSn10 (B10)
- bocca di mandata in bronzo GCuSn10 (B10)
- valvola di ritegno in bronzo GCuSn10 (B10)
- albero in acciaio inox AISI 316
- copri cavo in acciaio inox AISI 316
- griglia d'aspirazione in acciaio inox AISI 316
- viteria in acciaio inox AISI 316

CARATTERISTICHE:

- portata massima: 2667 l/m
- prevalenza massima: 384 metri
- potenza massima: 110 Kw
- diametro d'ingombro massimo: 198 mm (incluso il copri cavo)
- temperatura massima dell'acqua: 60°C (solo per corpo pompa, per il motore vedi catalogo motori)
- contenuto di sabbia massimo: 100 g/m³



APPLICATIONS:

- irrigation, water supply system, pressure boosting, fire-fighting systems
- sea water
- brackish water

CONSTRUCTION:

- bronze GCuSn10 (B10) impellers
- bronze GCuSn10 (B10) delivery bowl
- bronze GCuSn10 (B10) pump body
- bronze GCuSn10 (B10) non-return valve
- stainless steel AISI 316 shaft
- stainless steel AISI 316 cable cover
- stainless steel AISI 316 suction strainer
- stainless steel AISI 316 nuts, bolts and screws

FEATURES:

- maximum capacity: 2667 l/m
- maximum head: 384 meters
- maximum power: 110 Kw
- maximum encumbrance diameter: 198 mm (cable cover included)
- maximum water temperature: 60°C (only for the pump, for the motor see motors' catalogue)
- maximum sand content: 100 g/m³



APPLICATIONS:

- irrigation, installation d'approvisionnement hydrique, surpression et anti incendie
- eau de mer
- eau saumâtre

CONSTRUCTION:

- roues en bronze GCuSn10 (B10)
- corps d'étage en bronze GCuSn10 (B10)
- orifice de refoulement bronze GCuSn10 (B10)
- crépine de non-retour en bronze GCuSn10 (B10)
- arbre en acier inoxydable AISI 316
- couvre-câble en acier inoxydable AISI 316
- crépine d'aspiration en acier inoxydable AISI 316
- visserie en acier inoxydable AISI 316

CARACTÉRISTIQUES:

- débit maximum: 2667 l/m
- hauteur maximale: 384 mètres
- puissance maximale: 110 Kw
- diamètre d'encombrement maximum: 198 mm (inclus le couvre-câble)
- température maximale de l'eau: 60°C (pour la pompe, pour le moteur voir le catalogue des moteurs)
- quantité maximale de sable: 100 g/m³



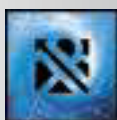

ELETTROPOMPE SOMMERSE 8" SEMIASSIALI IN ACCIAIO INOX AISI 316 E DUPLEX

8" STAINLESS STEEL AISI 316 AND DUPLEX MIXED-FLOW SUBMERSIBLE ELECTROPUMPS

ÉLECTROPOMPES IMMERGÉES 8" SEMI-AXIALES EN ACIER INOXYDABLE AISI 316 ET DUPLEX



APPLICAZIONI:

- irrigazione, approvvigionamento idrico, aumento pressione ed antincendio
- acqua potabile
- acque di mare
- acque salmastre
- acque termali e sulfuree
- desalinizzazione ed osmosi
- acque aggressive e corrosive
- vari settori dell'industria: alimentare, petrolchimica, siderurgica e navale
- applicazioni gravose: miniera

COSTRUZIONE IN ACCIAIO INOX AISI 316:

PREN 26 (Pitting Resistance Equivalent)

- girante in acciaio inox AISI 316 (W. Nr. 1.4401)
- corpo di stadio in acciaio inox AISI 316 (W. Nr. 1.4401)
- bocca di mandata in acciaio inox AISI 316 (W. Nr. 1.4401)
- valvola di ritegno in acciaio inox AISI 316 (W. Nr. 1.4401)
- albero in acciaio inox AISI 316 (W. Nr. 1.4401)
- copri cavo in acciaio inox AISI 316 (W. Nr. 1.4401)
- griglia d'aspirazione in acciaio inox AISI 316 (W. Nr. 1.4401)
- viteria in acciaio inox AISI 316 (W. Nr. 1.4401)

COSTRUZIONE IN ACCIAIO INOX DUPLEX:

PREN 31 (Pitting Resistance Equivalent)

- girante in acciaio inox duplex (W. Nr. 1.4462)
- corpo di stadio in acciaio inox duplex (W. Nr. 1.4462)
- bocca di mandata in acciaio inox duplex (W. Nr. 1.4462)
- valvola di ritegno in acciaio inox duplex (W. Nr. 1.4462)
- albero in acciaio inox duplex (W. Nr. 1.4462)
- copri cavo in acciaio inox duplex (W. Nr. 1.4462)
- griglia d'aspirazione in acciaio inox duplex (W. Nr. 1.4462)
- viteria in acciaio inox duplex (W. Nr. 1.4462)

CARATTERISTICHE:

- portata massima: 2667 l/m
- prevalenza massima: 384 metri
- potenza massima: 110 Kw
- diametro d'ingombro massimo: 198 mm (incluso il copri cavo)
- temperatura massima dell'acqua: 60°C (solo per corpo pompa, per il motore vedi catalogo motori)
- contenuto di sabbia massimo: 100 g/m³



APPLICATIONS:

- irrigation, water supply system, pressure boosting, fire-fighting systems
- sea water
- brackish water
- drinking water
- thermal and sulphurous water
- desalinization and osmosis
- aggressive and corrosive waters
- different sectors of the industry: such as food, petrochemical, steel and shipbuilding
- hard applications: mine

STAINLESS STEEL AISI 316 CONSTRUCTION:

PREN 26 (Pitting Resistance Equivalent)

- stainless steel AISI 316 (W. Nr. 1.4401) impellers
- stainless steel AISI 316 (W. Nr. 1.4401) delivery bowl
- stainless steel AISI 316 (W. Nr. 1.4401) pump body
- stainless steel AISI 316 (W. Nr. 1.4401) non-return valve
- stainless steel AISI 316 (W. Nr. 1.4401) shaft
- stainless steel AISI 316 (W. Nr. 1.4401) cable cover
- stainless steel AISI 316 (W. Nr. 1.4401) suction strainer
- stainless steel AISI 316 (W. Nr. 1.4401) nuts, bolts and screws

STAINLESS STEEL DUPLEX CONSTRUCTION:

PREN 31 (Pitting Resistance Equivalent)

- stainless steel duplex (W. Nr. 1.4462) impellers
- stainless steel duplex (W. Nr. 1.4462) delivery bowl
- stainless steel duplex (W. Nr. 1.4462) pump body
- stainless steel duplex (W. Nr. 1.4462) non-return valve
- stainless steel duplex (W. Nr. 1.4462) shaft
- stainless steel duplex (W. Nr. 1.4462) cable cover
- stainless steel duplex (W. Nr. 1.4462) suction strainer
- stainless steel duplex (W. Nr. 1.4462) nuts, bolts and screws

FEATURES:

- maximum capacity: 2667 l/m
- maximum head: 384 meters
- maximum power: 110 Kw
- maximum encumbrance diameter: 198 mm (cable cover included)
- maximum water temperature: 60°C (only for the pump, for the motor see motors' catalogue)
- maximum sand content: 100 g/m³



APPLICATIONS:

- irrigation, installation d'approvisionnement hydrique, surpression et anti incendie
- eau potable
- eau de mer
- eau saumâtre
- eau thermale e sulfureuse
- dessalement et osmose
- eau aggressive et corrosives
- différents secteurs de l'industrie: alimentaire, pétrochimie, sidérurgique et navale
- applications dures: mine

CONSTRUCTION EN ACIER INOXYDABLE AISI 316

PREN 26 (Pitting Resistance Equivalent)

- roues en acier inoxydable AISI 316 (W. Nr. 1.4401)
- corps d'étage en acier inoxydable AISI 316 (W. Nr. 1.4401)
- orifice de refoulement en acier inoxydable AISI 316 (W. Nr. 1.4401)
- crépine de non-retour en acier inoxydable AISI 316 (W. Nr. 1.4401)
- arbre en acier inoxydable AISI 316 (W. Nr. 1.4401)
- couvre-câble en acier inoxydable AISI 316 (W. Nr. 1.4401)
- crépine d'aspiration en acier inoxydable AISI 316 (W. Nr. 1.4401)
- visserie en acier inoxydable AISI 316 (W. Nr. 1.4401)

CONSTRUCTION EN ACIER INOXYDABLE DUPLEX

PREN 31 (Pitting Resistance Equivalent)

- roues en acier inoxydable duplex (W. Nr. 1.4462)
- corps d'étage en acier inoxydable duplex (W. Nr. 1.4462)
- orifice de refoulement en acier inoxydable duplex (W. Nr. 1.4462)
- crépine de non-retour en acier inoxydable duplex (W. Nr. 1.4462)
- arbre en acier inoxydable duplex (W. Nr. 1.4462)
- couvre-câble en acier inoxydable duplex (W. Nr. 1.4462)
- crépine d'aspiration en acier inoxydable duplex (W. Nr. 1.4462)
- visserie en acier inoxydable (W. Nr. 1.4462)

CARACTÉRISTIQUES:

- débit maximum: 2667 l/m
- hauteur maximale: 384 mètres
- puissance maximale: 110 Kw
- diamètre d'encombrement maximum: 198 mm (inclus le couvre-câble)
- température maximale de l'eau: 60°C (pour la pompe, pour le moteur voir le catalogue des moteurs)
- quantité maximale de sable: 100 g/m³



SPACCATO 8"

8" CUTAWAY
COUPE 8"

FB8S

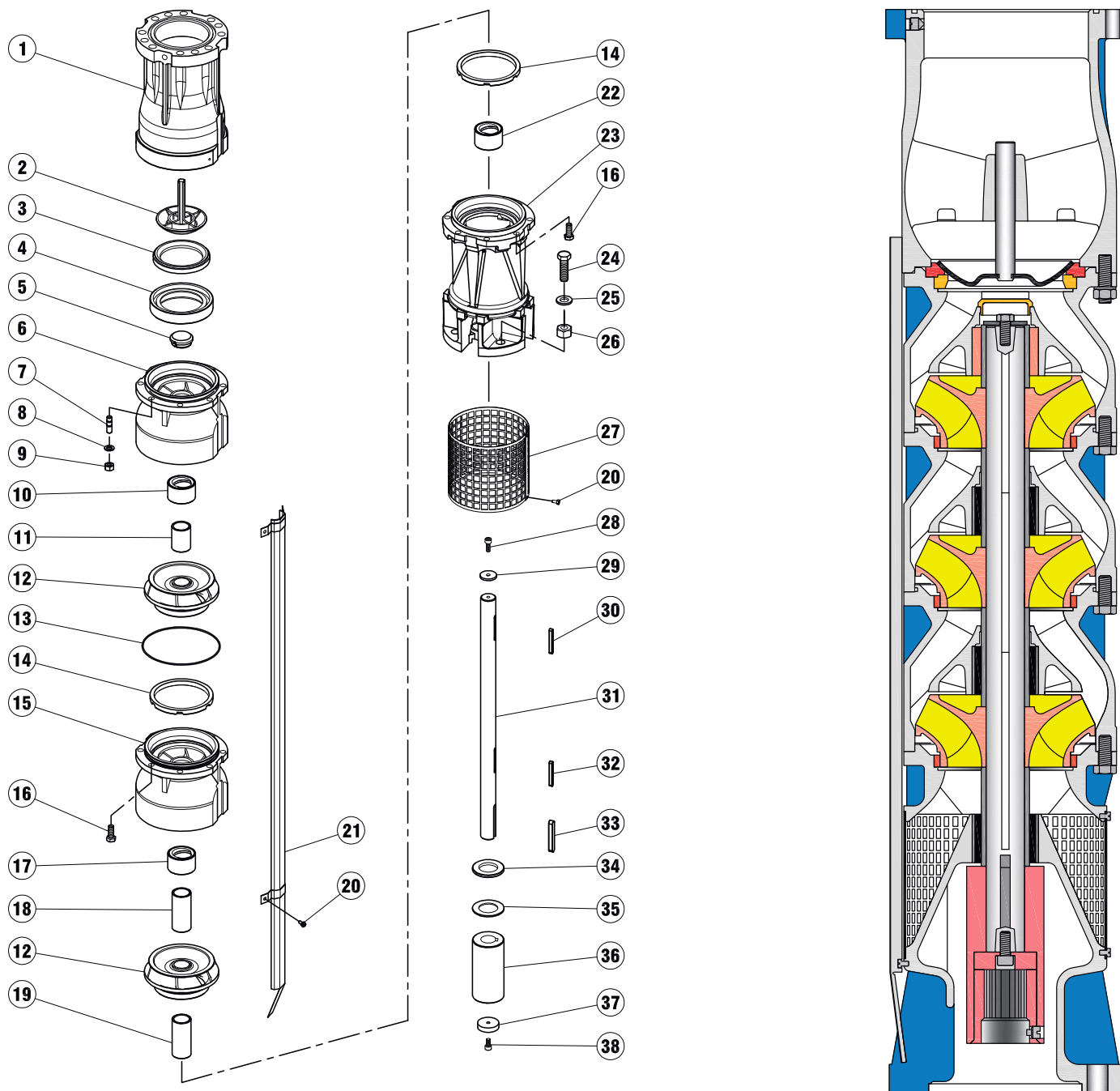
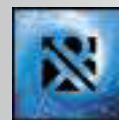

Pos.	Qt.	Denominazione	Denomination	Denomination
1	1	Corpo della valvola	Valve body	Corps de clapet
2	1	Otturatore della valvola	Wing valve	Soupape du clapet
3	1	Sede valvola	Valve seat	Siège de soupape
4	1	Anello di raccordo valv.	Valve insert ring	Bague du clapet
5	1	Corperchio di protez.	Vent plug	Bouchon de purge d'air
6	1	Corpo raddrizzatore	Pump bowl	Corps redresseur
7	8	Prigioniero	Stud	Goujon
8	8	Rosetta	Washer	Rondelle
9	8	Dado	Nut	Ecrou
10	1	Cuscinetto a boccola	Bearing bush	Coussinet
11	1	Bussola distanziale	Bearing sleeve	Chemise d'arbre
12	*N	Girante	Impeller	Roue
13	*N-1	Guarnizione corpo	Joint for stage casing	Joint du corps d'étage
14	*N-1	Anello di usura fisso	Casing wear ring	Bague d'usure
15	*N-1	Corpo raddrizzatore	Pump bowl	Corps redresseur
16	*Nx8	Vite	Screw	Vis
17	*N-1	Bussola intermedia	Interstage bush	Douille entre étages
18	*N-1	Bussola interstadi	Interstage sleeve	Chemise entretoise
19	1	Bussola distanziale	Bearing sleeve	Chemise d'arbre

*N=Numero di scatole e giranti variabili dal tipo di pompa

*N=The number of the boxer and the impellers vary according to the type of the pump.

*N=Numéro d'enveloppes et roues selon le type de pompe.

Pos.	Qt.	Denominazione	Denomination	Denomination
20	6-14	Vite	Screw	Vis
21	1-2	Tegolo protezione cavo	Cable guard	Protège-cable
22	1	Cuscinetto a boccola	Bearing bush	Coussinet
23	1	Camera aspirante	Suction casing	Corps d'aspiration
24	4	Vite	Screw	Vis
25	4	Rosetta	Washer	Rondelle
26	4	Dado	Nut	Ecrou
27	1	Griglia d'aspirazione	Suction strainer	Crépine d'aspiration
28	1	Vite	Screw	Vis
29	1	Rosetta ghiera albero	Washer for shaft nut	Rondelle pour arbre
30	*N-1	Linguetta girante	Key for impeller	Clavette de la roue
31	1	Albero pompa	Pump shaft	Arbre de pompe
32	1	Linguetta girante	Key for impeller	Clavette de la roue
33	1	Linguetta giunto	Key for coupling	Clavette pour accoupl.
34	1	Anello contosp. fisso	Counter ring	Grain fixe de contre
35	1	Anello contosp. mobile	Counter ring	Grain fixe de contre
36	1	Giunto	Coupling	Accouplement
37	1	Disco del giunto	Thrust insert for coupl.	Vis de butée accoupl.
38	1	Vite	Screw	Vis



TABELLA DELLE CARATTERISTICHE IDRAULICHE 8"

8" HYDRAULIC FEATURES' CHART

TABLE DES CARACTÉRISTIQUES HYDRAULIQUES 8"

Tipo Type Type	Motore Motor Moteur		Q = Portata - Capacity - Débit																		
			l/sec	0	8,3	11,1	13,9	16,7	19,5	22,2	25	27,8	30,6	33,3	36,1	38,9	41,7	44,5			
				l/min	0	500	667	833	1000	1167	1333	1500	1667	1833	2000	2167	2333	2500	2667		
			mc/h		0	30	40	50	60	70	80	90	100	110	120	130	140	150	160		
FB8SE/1A	7,5	5,5		24	21	20	18	17	16	14	12	9									
FB8SE/2F	10	7,5		45	37	34	32	29	26	22	17	11									
FB8SE/2A	12,5	9,2		48	41	39	37	34	31	28	24	18									
FB8SE/3F	15	11		69	57	53	49	45	39	34	26	17									
FB8SE/3A	17,5	13		74	63	60	56	52	48	42	36	28									
FB8SE/4F	20	15		93	76	71	65	59	52	45	35	23									
FB8SE/4A	25	18,5		100	85	81	76	70	64	57	49	38									
FB8SE/5A	30	22		126	108	102	96	89	81	72	61	48									
FB8SE/6A	35	26	H(m)	153	131	124	116	107	98	88	74	58									
FB8SE/7A	40	30		179	153	144	135	125	113	100	85	67									
FB8SE/8A	50	37		204	174	165	154	143	131	117	99	77									
FB8SE/9A	60	45		230	196	185	174	161	148	131	112	86									
FB8SE/10A	60	45		255	218	206	193	179	164	146	124	96									
FB8SE/11A	70	51		280	242	226	213	196	180	159	137	108									
FB8SE/12A	75	55		306	262	247	232	215	197	175	149	115									
FB8SE/13A	80	59		332	285	268	252	233	213	189	163	127									
FB8SE/14A	85	62		357	305	288	270	251	230	204	174	134									
FB8SE/15A	90	66		383	327	309	290	269	246	219	186	144									
FB8SG/1A	7,5	5,5		26			20	19	18	16	15	14	12	9							
FB8SG/2L	10	7,5		42			32	29	27	24	22	18	13	9							
FB8SG/2F	12,5	9,2		48			37	35	32	29	27	23	19	14							
FB8SG/2A	15	11		51			40	38	35	33	30	27	23	18							
FB8SG/3G	17,5	13		68			53	49	45	41	36	31	24	17							
FB8SG/3D	20	15		76			57	54	50	47	43	38	32	24							
FB8SG/3A	25	18,5		79			62	58	54	50	47	42	36	28							
FB8SG/4A	30	22		106			83	78	73	68	63	56	48	38							
FB8SG/5A	35	26	H(m)	134			105	99	92	86	79	71	61	48							
FB8SG/6D	40	30		156			119	111	103	96	88	78	66	50							
FB8SG/7A	50	37		189			148	139	130	121	112	101	86	68							
FB8SG/8A	60	45		216			170	159	149	138	128	115	98	78							
FB8SG/9A	70	51		243			191	180	167	156	144	129	111	86							
FB8SG/10A	75	55		270			212	199	186	173	160	144	123	97							
FB8SG/11A	80	59		297			233	219	204	190	176	157	135	105							
FB8SG/12A	85	62		324			254	239	223	208	192	173	148	116							
FB8SG/13D	90	66		348			260	247	228	215	195	176	150	111							
FB8SG/14A	100	75		378			297	279	260	242	224	202	272	136							

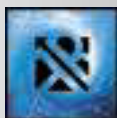
TABELLA DELLE CARATTERISTICHE IDRAULICHE 8”

8” HYDRAULIC FEATURES’ CHART

TABLE DES CARACTÉRISTIQUES HYDRAULIQUES 8”

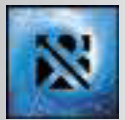

n=2900 1/min 50 Hz

Tipo Type Type	Motore Motor Moteur		Q = Portata - Capacity - Débit																			
			l/sec	0	8,3	11,1	13,9	16,7	19,5	22,2	25	27,8	30,6	33,3	36,1	38,9	41,7	44,5				
				l/min	0	500	667	833	1000	1167	1333	1500	1667	1833	2000	2167	2333	2500	2667			
			mc/h		0	30	40	50	60	70	80	90	100	110	120	130	140	150	160			
Hp	Kw	mc/h																				
FB8SH/1A	10	7,5	24					19	18	17	16	15	14	12	11							
FB8SH/2N	12,5	9,2	37					27	25	23	21	19	16	13	10							
FB8SH/2F	15	11	45					34	31	30	28	26	23	20	16							
FB8SH/2A	17,5	13	49					38	36	34	32	30	28	25	22							
FB8SH/3G	20	15	65					47	44	42	39	35	32	26	20							
FB8SH/3D	25	18,5	71					54	51	48	46	42	39	34	29							
FB8SH/3A	30	22	74					58	55	52	49	46	42	38	33							
FB8SH/4A	35	26	100					78	74	71	67	62	57	51	45							
FB8SH/5D	40	30	121					92	87	82	78	72	66	58	50							
FB8SH/6D	50	37	147					112	105	100	95	88	80	71	60							
FB8SH/7A	60	45	179				H(m)	140	132	126	119	111	102	92	80							
FB8SH/8D	70	51	196					148	140	133	126	117	106	94	80							
FB8SH/8A	75	55	205					160	151	144	136	127	117	105	91							
FB8SH/9A	80	59	230					180	170	162	153	143	131	118	103							
FB8SH/10D	85	62	245					185	175	165	157	146	133	118	100							
FB8SH/10A	90	66	255					200	189	188	170	159	145	131	113							
FB8SH/11A	100	75	282					220	208	198	187	175	161	144	125							
FB8SH/12A	125	92	307					240	227	216	204	191	175	157	137							
FB8SH/13A	125	92	333					260	246	234	221	207	190	170	148							
FB8SH/14A	125	92	358					280	265	252	238	223	204	183	160							
FB8SH/15A	150	110	384					300	284	270	255	239	219	197	171							
FB8SL/1A	12,5	9,2	25							19	18	17	17	16	15	13	12					
FB8SL/2L	15	11	40							29	27	26	23	21	19	16	12					
FB8SL/2G	17,5	13	42							30	29	28	26	24	21	18	15					
FB8SL/2F	20	15	45							34	32	31	29	27	25	22	19					
FB8SL/2A	25	18,5	50							38	36	35	33	32	29	27	24					
FB8SL/3F	30	22	69							52	49	47	44	41	38	33	29					
FB8SL/3A	35	26	77							58	56	54	51	49	45	41	36					
FB8SL/4F	40	30	93							70	66	63	59	55	51	44	39					
FB8SL/4A	50	37	103							78	75	72	69	65	60	55	49					
FB8SL/5A	60	45	131							99	95	91	87	83	76	69	61					
FB8SL/6A	70	51	158				H(m)			119	115	110	106	100	92	84	74					
FB8SL/7D	75	55	174							132	127	122	116	109	100	90	78					
FB8SL/7A	80	59	185							139	134	129	123	117	108	98	87					
FB8SL/8D	85	62	199							151	145	139	133	125	114	103	89					
FB8SL/8A	90	66	211							159	153	147	141	134	123	112	99					
FB8SL/9A	100	75	238							179	173	166	158	150	139	126	112					
FB8SL/10A	125	92	264							199	192	184	176	167	154	140	124					
FB8SL/11A	125	92	290							219	211	202	194	184	169	154	136					
FB8SL/12A	150	110	317							239	230	221	211	200	185	168	149					
FB8SL/13A	150	110	343							259	250	239	229	217	200	182	161					

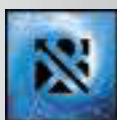

Tipo Type Type	Motore Motors 2900 g/m Moteurs		Q = Portata - Capacity - Débit									
			l/sec	0	8,3	11,1	13,9	16,7	19,5	22,2	25	27,8
	Cv Hp	Kw	l/min	0	500	667	833	1000	1167	1333	1500	1667
			mc/h	0	30	40	50	60	70	80	90	100
FB8SE/1A + 6F7	7,5	5,5	24	21	20	18	17	16	14	12	9	
FB8SE/2F + 6F10	10	7,5	45	37	34	32	29	26	22	17	11	
FB8SE/2A + 6F12	12,5	9,2	48	41	39	37	34	31	28	24	18	
FB8SE/3F + 6F15	15	11	69	57	53	49	45	39	34	26	17	
FB8SE/3A + 6F17	17,5	13	74	63	60	56	52	48	42	36	28	
FB8SE/4F + 6F20	20	15	93	76	71	65	59	52	45	35	23	
FB8SE/4A + 6F25	25	18,5	100	85	81	76	70	64	57	49	38	
FB8SE/5A + 6F30	30	22	126	108	102	96	89	81	72	61	48	
FB8SE/6A + 6F35	35	26	153	131	124	116	107	98	88	74	58	
FB8SE/7A + 8F40	40	30	179	153	144	135	125	113	100	85	67	
FB8SE/8A + 8F50	50	37	204	174	165	154	143	131	117	99	77	
FB8SE/9A + 8F60	60	45	230	196	185	174	161	148	131	112	86	
FB8SE/10A + 8F60	60	45	255	218	206	193	179	164	146	124	96	
FB8SE/11A + 8F70	70	51	280	242	226	213	196	180	159	137	108	
FB8SE/12A + 8F75	75	55	306	262	247	232	215	197	175	149	115	
FB8SE/13A + 8F80*	80	59	332	285	268	252	233	213	189	163	127	
FB8SE/14A + 8F85*	85	62	357	305	288	270	251	230	204	174	134	
FB8SE/15A + 8F90*	90	66	383	327	309	290	269	246	219	186	144	



Dimensioni e pesi

Overall dimensions and weights - Dimensions d'encombrement et poids

Tipo Type Type	Cv Hp	Kw	A (mm)	B (mm)	C (mm)	D (mm)	ø max (mm)	DN	Peso - Weight - Poids		
									A (kg)	B (kg)	C (kg)
									FB8SE/1A + 6F7	7,5	5,5
FB8SE/2F + 6F10	10	7,5	1403	736	667	102	52	50			
FB8SE/2A + 6F12	12,5	9,2	1433	736	697	106	52	54			
FB8SE/3F + 6F15	15	11	1635	868	767	123	62	61			
FB8SE/3A + 6F17	17,5	13	1635	868	767	124	62	62			
FB8SE/4F + 6F20	20	15	1827	1000	827	140	72	68			
FB8SE/4A + 6F25	25	18,5	1897	1000	897	147	72	75			
FB8SE/5A + 6F30	30	22	2099	1132	967	164	82	82			
FB8SE/6A + 6F35	35	26	2291	1264	1027	181	92	89			
FB8SE/7A + 8F40	40	30	2473	1424	1049	243	105	138			
FB8SE/8A + 8F50	50	37	2675	1556	1119	268	115	153			
FB8SE/9A + 8F60	60	45	2897	1668	1229	296	125	171			
FB8SE/10A + 8F60	60	45	3049	1820	1229	306	135	171			
FB8SE/11A + 8F70	70	51	3181	1952	1229	317	145	172			
FB8SE/12A + 8F75	75	55	3433	2084	1349	339	155	184			
FB8SE/13A + 8F80*	80	59	3565	2216	1349	349	165	184			
FB8SE/14A + 8F85*	85	62	3697	2348	1349	359	175	184			
FB8SE/15A + 8F90*	90	66	3899	2480	1419	390	185	205			

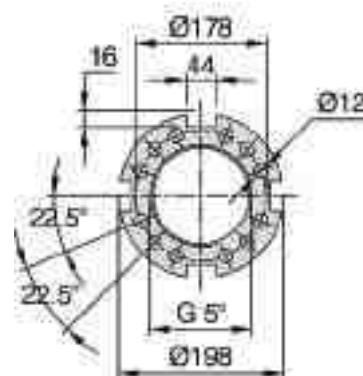

* Non consigliata per montaggio in posizione orizzontale

* This electropump isn't recommended for horizontal assemblage

* Cette électropompe n'est pas recommandée pour le montage en position horizontale

CURVE DELLE PRESTAZIONI

PERFORMANCES' CURVES

COURBES DES PERFORMANCES

FB8SE

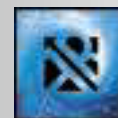

n=2900 1/min 50 Hz

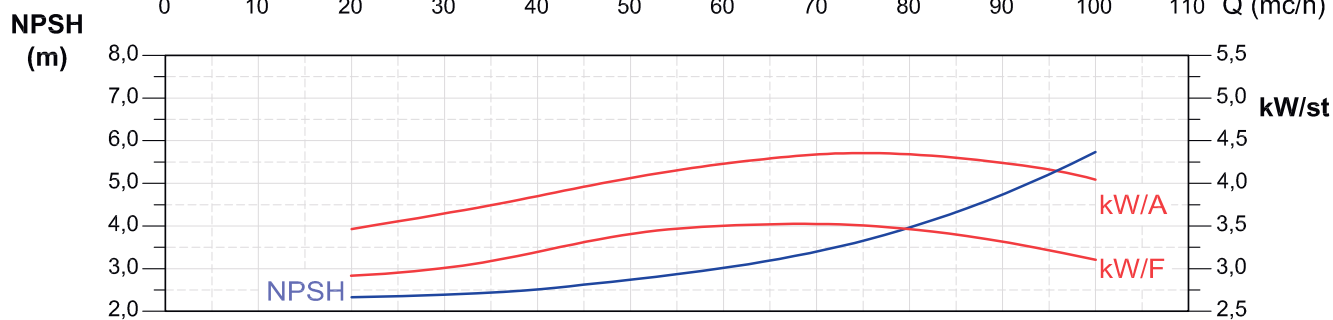
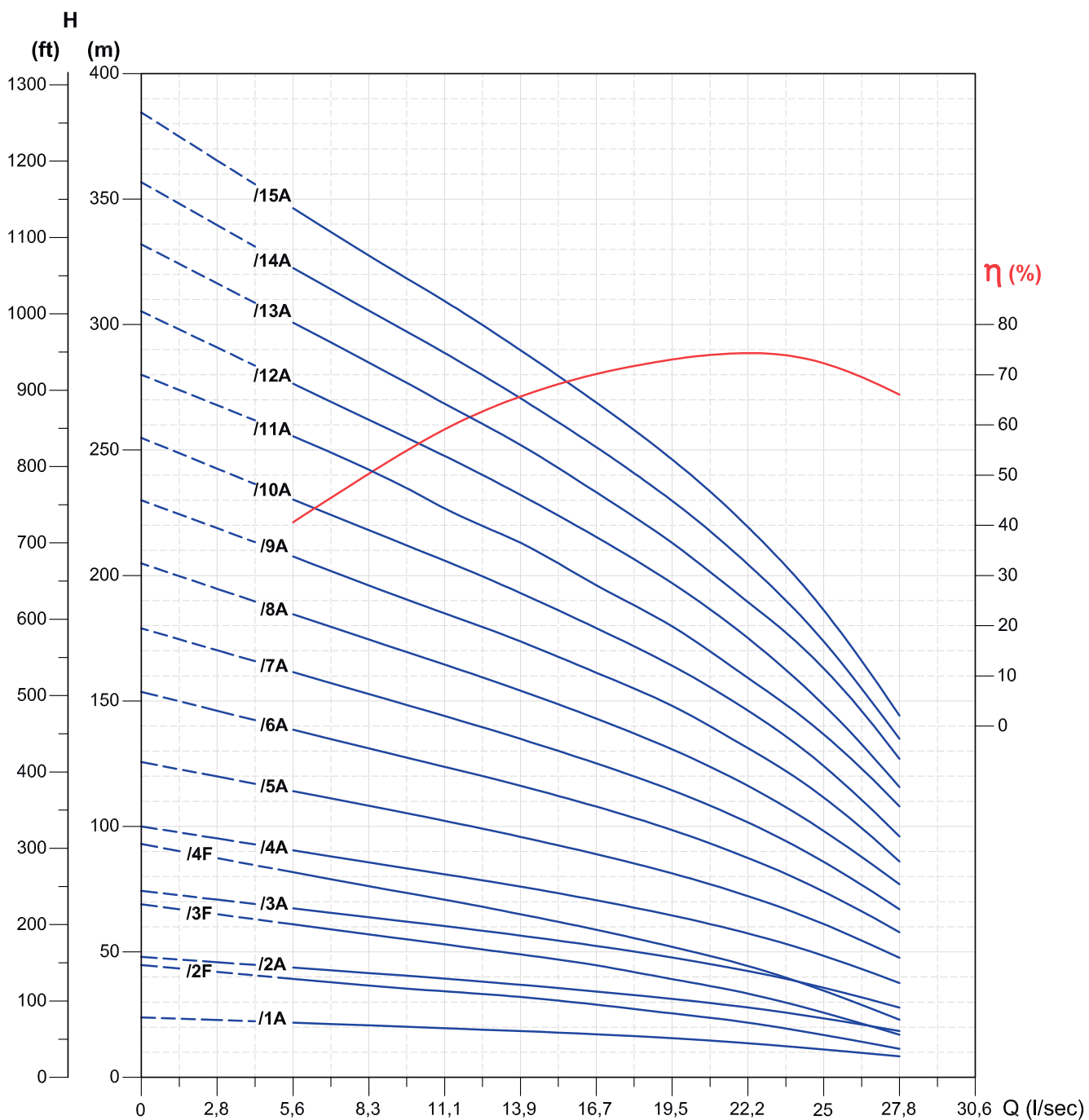

Tolleranze secondo EN ISO 9906 app.A Gr.2 - Tolerances according to EN ISO 9906 anx.A Gr.2 - Tolérances conformes EN ISO 9906 ann.A Gr.2

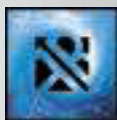

Tipo Type Type	Motore Motors 2900 g/m Moteurs		Q = Portata - Capacity - Débit									
	Cv Hp	Kw	l/sec	0	13,9	16,7	19,5	22,2	25	27,8	30,6	33,3
			l/min	0	833	1000	1167	1333	1500	1667	1833	2000
			mc/h	0	50	60	70	80	90	100	110	120
FB8SG/1A + 6F7	7,5	5,5		26	20	19	18	16	15	14	12	9
FB8SG/2L + 6F10	10	7,5		42	32	29	27	24	22	18	13	9
FB8SG/2F + 6F12	12,5	9,2		48	37	35	32	29	27	23	19	14
FB8SG/2A + 6F15	15	11		51	40	38	35	33	30	27	23	18
FB8SG/3G + 6F17	17,5	13		68	53	49	45	41	36	31	24	17
FB8SG/3D + 6F20	20	15		76	57	54	50	47	43	38	32	24
FB8SG/3A + 6F25	25	18,5		79	62	58	54	50	47	42	36	28
FB8SG/4A + 6F30	30	22		106	83	78	73	68	63	56	48	38
FB8SG/5A + 6F35	35	26	H(m)	134	105	99	92	86	79	71	61	48
FB8SG/6D + 8F40	40	30		156	119	111	103	96	88	78	66	50
FB8SG/7A + 8F50	50	37		189	148	139	130	121	112	101	86	68
FB8SG/8A + 8F60	60	45		216	170	159	149	138	128	115	98	78
FB8SG/9A + 8F70	70	51		243	191	180	167	156	144	129	111	86
FB8SG/10A + 8F75	75	55		270	212	199	186	173	160	144	123	97
FB8SG/11A + 8F80	80	59		297	233	219	204	190	176	157	135	105
FB8SG/12A + 8F85*	85	62		324	254	239	223	208	192	173	148	116
FB8SG/13D + 8F90*	90	66		348	260	247	228	215	195	176	150	111
FB8SG/14A + 8F100*	100	75		378	297	279	260	242	224	202	272	136



Dimensioni e pesi

Overall dimensions and weights - Dimensions d'encombrement et poids

Tipo Type Type	Cv Hp	Kw	A (mm)	B (mm)	C (mm)	D (mm)	ø max (mm)	DN	Peso - Weight - Poids		
									A (kg)	B (kg)	C (kg)
FB8SG/1A + 6F7	7,5	5,5	1231	604	627				88	42	46
FB8SG/2L + 6F10	10	7,5	1403	736	667				102	52	50
FB8SG/2F + 6F12	12,5	9,2	1433	736	697				106	52	54
FB8SG/2A + 6F15	15	11	1503	736	767				113	52	61
FB8SG/3G + 6F17	17,5	13	1635	868	767	145			124	62	62
FB8SG/3D + 6F20	20	15	1695	868	827				130	62	68
FB8SG/3A + 6F25	25	18,5	1765	868	897				137	62	75
FB8SG/4A + 6F30	30	22	1967	1000	967				154	72	82
FB8SG/5A + 6F35	35	26	2159	1132	1027				171	82	89
FB8SG/6D + 8F40	40	30	2341	1292	1049		198	G 5"	233	95	138
FB8SG/7A + 8F50	50	37	2543	1424	1119				258	105	153
FB8SG/8A + 8F60	60	45	2785	1556	1229				286	115	171
FB8SG/9A + 8F70	70	51	2917	1688	1229				297	125	172
FB8SG/10A + 8F75	75	55	3169	1820	1349	192			319	135	184
FB8SG/11A + 8F80	80	59	3301	1952	1349				329	145	184
FB8SG/12A + 8F85*	85	62	3433	2084	1349				339	155	184
FB8SG/13D + 8F90*	90	66	3635	2216	1419				370	165	205
FB8SG/14A + 8F100*	100	75	3957	2348	1609				411	175	236

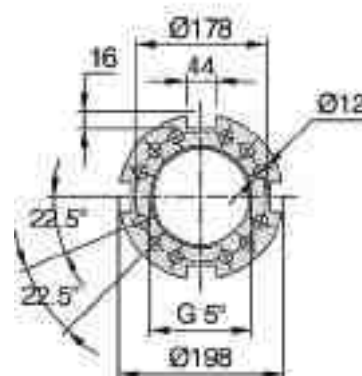

* Non consigliata per montaggio in posizione orizzontale

* This electropump isn't recommended for horizontal assemblage

* Cette électropompe n'est pas recommandée pour le montage en position horizontale

CURVE DELLE PRESTAZIONI

PERFORMANCES' CURVES

COURBES DES PERFORMANCES

FB8SG

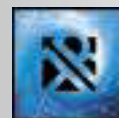

n=2900 1/min 50 Hz

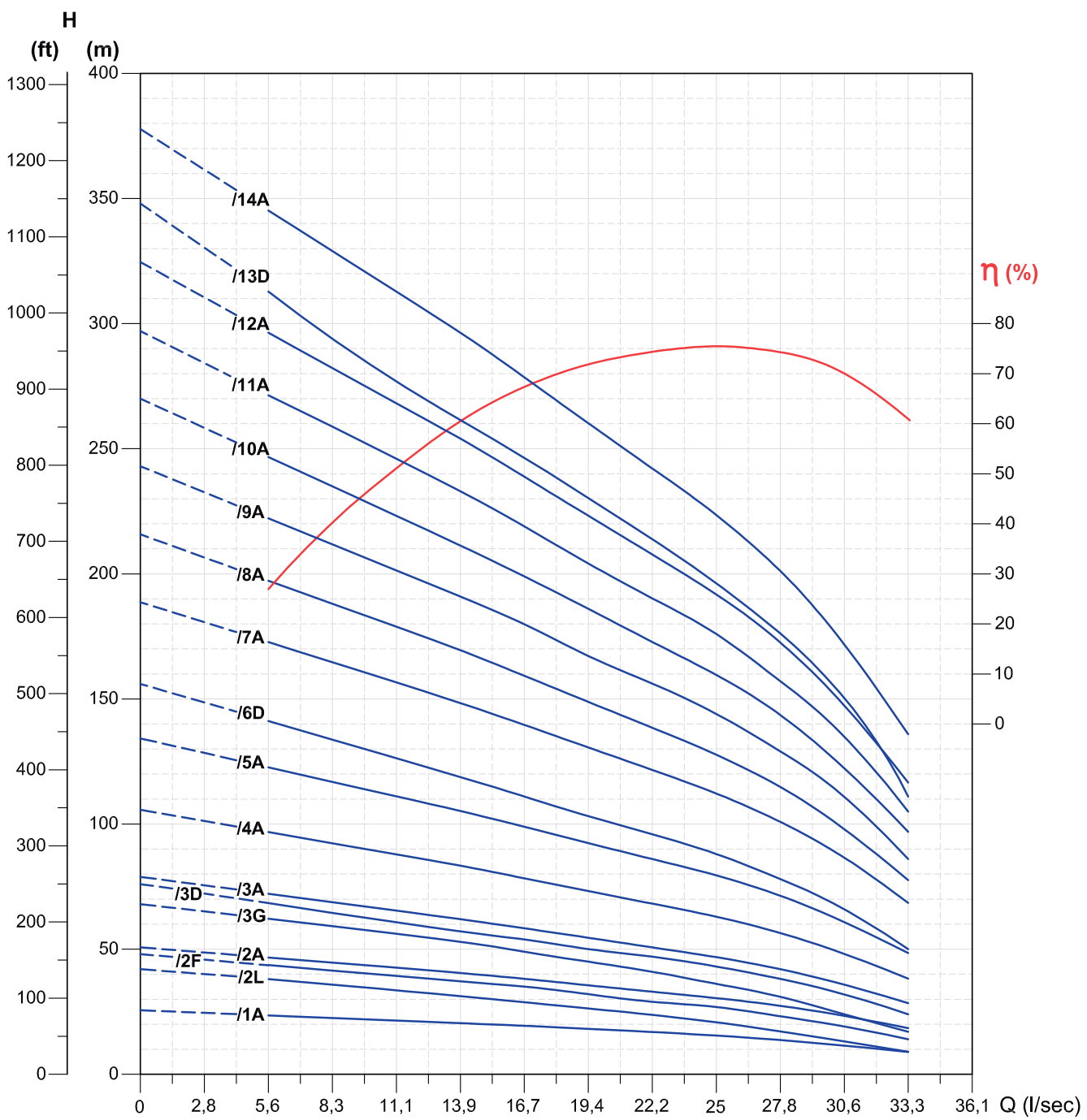

NPSH (m)

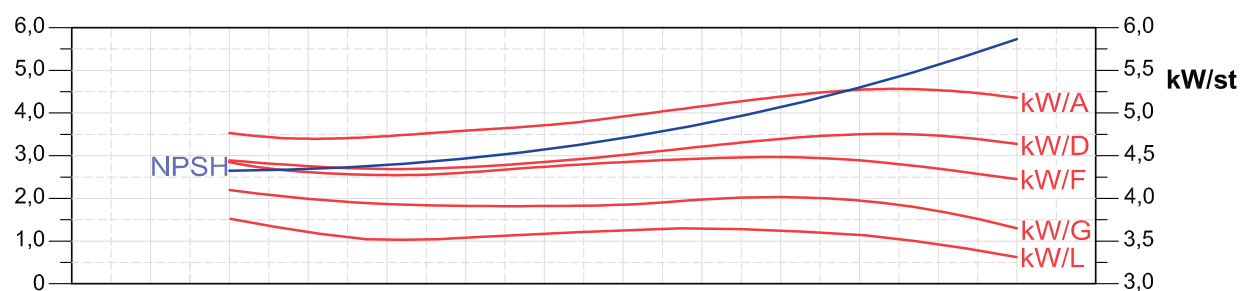

Tolleranze secondo EN ISO 9906 app.A Gr.2 - Tolerances according to EN ISO 9906 anx.A Gr.2 - Tolérances conformes EN ISO 9906 ann.A Gr.2

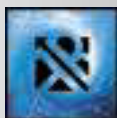

Tipo Type Type	Motore Motors 2900 g/m Moteurs		Q = Portata - Capacity - Débit									
			l/sec	0	19,5	22,2	25	27,8	30,6	33,3	36,1	38,9
	Cv Hp	Kw	l/min	0	1167	1333	1500	1667	1833	2000	2167	2333
			mc/h	0	70	80	90	100	110	120	130	140
FB8SH/1A + 6F10	10	7,5	H(m)	24	19	18	17	16	15	14	12	11
FB8SH/2N + 6F12	12,5	9,2		37	27	25	23	21	19	16	13	10
FB8SH/2F + 6F15	15	11		45	34	31	30	28	26	23	20	16
FB8SH/2A + 6F17	17,5	13		49	38	36	34	32	30	28	25	22
FB8SH/3G + 6F20	20	15		65	47	44	42	39	35	32	26	20
FB8SH/3D + 6F25	25	18,5		71	54	51	48	46	42	39	34	29
FB8SH/3A + 6F30	30	22		74	58	55	52	49	46	42	38	33
FB8SH/4A + 6F35	35	26		100	78	74	71	67	62	57	51	45
FB8SH/5D + 8F40	40	30		121	92	87	82	78	72	66	58	50
FB8SH/6D + 8F50	50	37		147	112	105	100	95	88	80	71	60
FB8SH/7A + 8F60	60	45		179	140	132	126	119	111	102	92	80
FB8SH/8D + 8F70	70	51		196	148	140	133	126	117	106	94	80
FB8SH/8A + 8F75	75	55		205	160	151	144	136	127	117	105	91
FB8SH/9A + 8F80	80	59		230	180	170	162	153	143	131	118	103
FB8SH/10D + 8F85	85	62		245	185	175	165	157	146	133	118	100
FB8SH/10A + 8F90*	90	66		255	200	189	188	170	159	145	131	113
FB8SH/11A + 8F100*	100	75		282	220	208	198	187	175	161	144	125
FB8SH/12A + 8F125*	125	92		307	240	227	216	204	191	175	157	137
FB8SH/13A + 8F125*	125	92		333	260	246	234	221	207	190	170	148
FB8SH/14A + 8F125*	125	92		358	280	265	252	238	223	204	183	160
FB8SH/15A + 8F150*	150	110		384	300	284	270	255	239	219	197	171



Dimensioni e pesi

Overall dimensions and weights - Dimensions d'encombrement et poids

Tipo Type Type	Cv Hp	Kw	A (mm)	B (mm)	C (mm)	D (mm)	ø max (mm)	DN	Peso - Weight - Poids		
									A (kg)	B (kg)	C (kg)
									FB8SH/1A + 6F10	10	7,5
FB8SH/2N + 6F12	12,5	9,2	1433	736	697	106	52	54			
FB8SH/2F + 6F15	15	11	1503	736	767	113	52	61			
FB8SH/2A + 6F17	17,5	13	1503	736	767	114	52	62			
FB8SH/3G + 6F20	20	15	1695	868	827	130	62	68			
FB8SH/3D + 6F25	25	18,5	1765	868	897	137	62	75			
FB8SH/3A + 6F30	30	22	1835	868	967	144	62	82			
FB8SH/4A + 6F35	35	26	2027	1000	1027	161	72	89			
FB8SH/5D + 8F40	40	30	2181	1132	1049	217	79	138			
FB8SH/6D + 8F50	50	37	2411	1292	1119	248	95	153			
FB8SH/7A + 8F60	60	45	2653	1424	1229	276	105	171			
FB8SH/8D + 8F70	70	51	2785	1556	1229	287	115	172			
FB8SH/8A + 8F75	75	55	2905	1556	1349	299	115	184			
FB8SH/9A + 8F80	80	59	3037	1688	1349	309	125	184			
FB8SH/10D + 8F85	85	62	3169	1820	1349	319	135	184			
FB8SH/10A + 8F90*	90	66	3239	1820	1419	340	135	205			
FB8SH/11A + 8F100*	100	75	3561	1952	1609	381	145	236			
FB8SH/12A + 8F125*	125	92	3763	2084	1679	393	155	238			
FB8SH/13A + 8F125	125	92	3895	2216	1679	403	165	238			
FB8SH/14A + 8F125*	125	92	4027	2348	1679	413	175	238			
FB8SH/15A + 8F150*	150	110	4269	2480	1789	450	185	265			

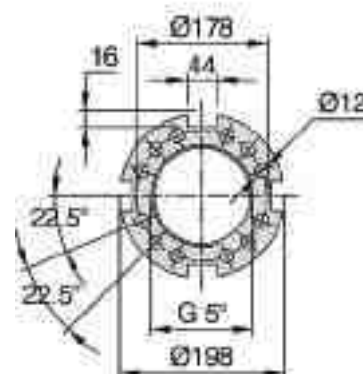

* **Non consigliata per montaggio in posizione orizzontale**

* This electropump isn't recommended for horizontal assemblage

* Cette électropompe n'est pas recommandée pour le montage en position horizontale

CURVE DELLE PRESTAZIONI

PERFORMANCES' CURVES

COURBES DES PERFORMANCES

FB8SH

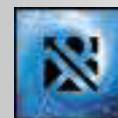

n=2900 1/min 50 Hz

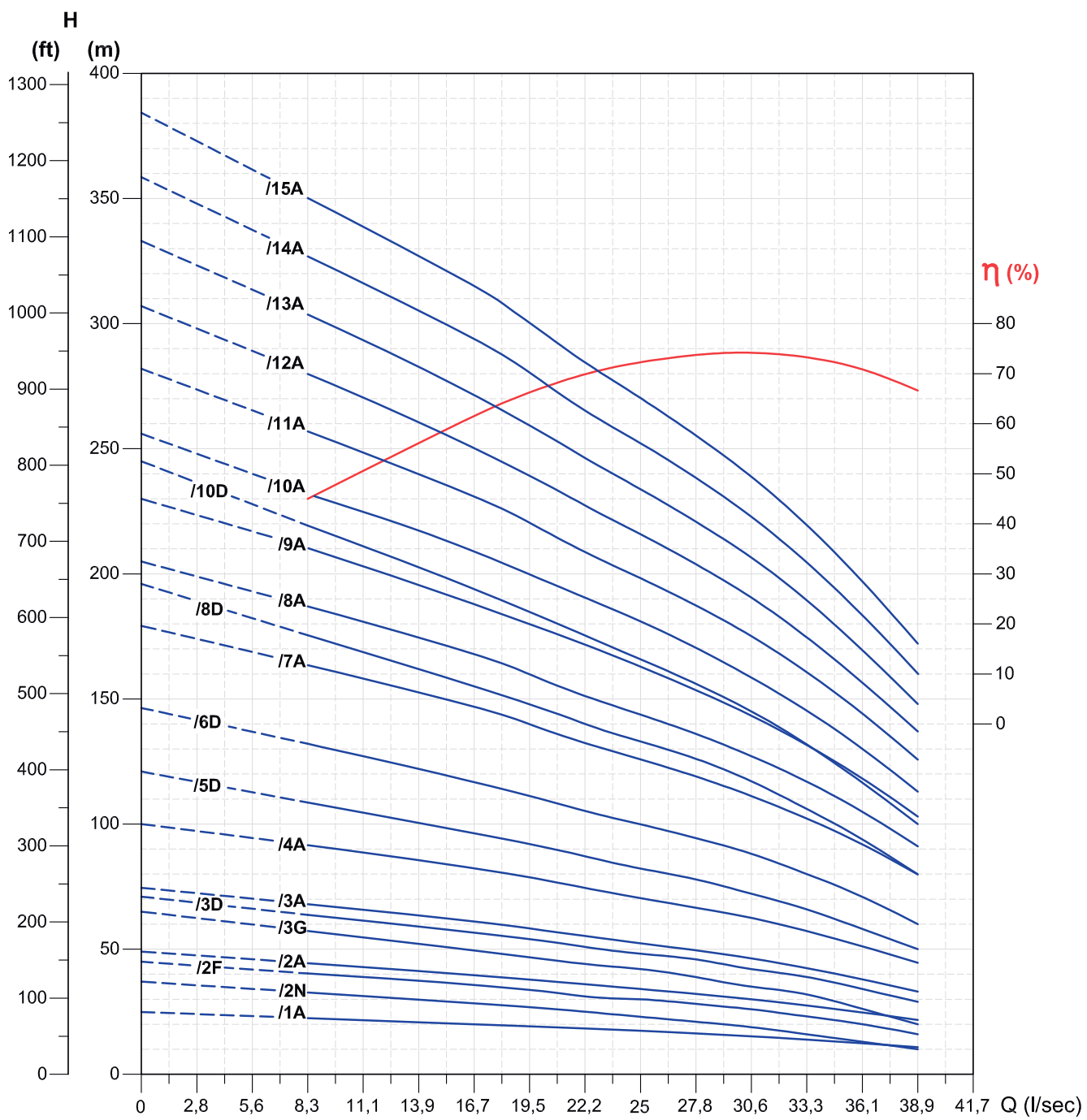

NPSH (m)

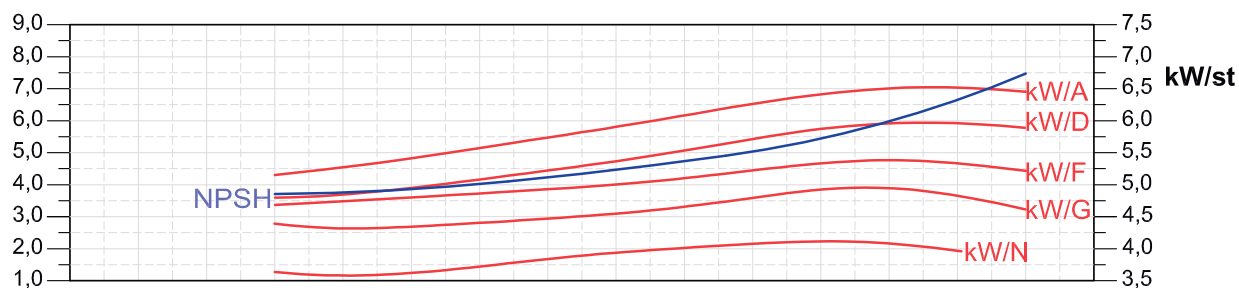

Tolleranze secondo EN ISO 9906 app.A Gr.2 - Tolerances according to EN ISO 9906 anx.A Gr.2 - Tolérances conformes EN ISO 9906 ann.A Gr.2

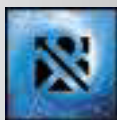

Tipo Type Type	Motore Motors Moteurs		Q = Portata - Capacity - Débit										
	2900 g/m		l/sec	0	25	27,8	30,6	33,3	36,1	38,9	41,7	44,5	
	Cv Hp	Kw		l/min	0	1500	1667	1833	2000	2167	2333	2500	2667
			mc/h	0	90	100	110	120	130	140	150	160	
FB8SL/1A + 6F12	12,5	9,2	H(m)	25	19	18	17	17	16	15	13	12	
FB8SL/2L + 6F15	15	11		40	29	27	26	23	21	19	16	12	
FB8SL/2G + 6F17	17,5	13		42	30	29	28	26	24	21	18	15	
FB8SL/2F + 6F20	20	15		45	34	32	31	29	27	25	22	19	
FB8SL/2A + 6F25	25	18,5		50	38	36	35	33	32	29	27	24	
FB8SL/3F + 6F30	30	22		69	52	49	47	44	41	38	33	29	
FB8SL/3A + 6F35	35	26		77	58	56	54	51	49	45	41	36	
FB8SL/4F + 8F40	40	30		93	70	66	63	59	55	51	44	39	
FB8SL/4A + 8F50	50	37		103	78	75	72	69	65	60	55	49	
FB8SL/5A + 8F60	60	45		131	99	95	91	87	83	76	69	61	
FB8SL/6A + 8F70	70	51		158	119	115	110	106	100	92	84	74	
FB8SL/7D + 8F75	75	55		174	132	127	122	116	109	100	90	78	
FB8SL/7A + 8F80	80	59		185	139	134	129	123	117	108	98	87	
FB8SL/8D + 8F85	85	62	199	151	145	139	133	125	114	103	89		
FB8SL/8A + 8F90*	90	66	211	159	153	147	141	134	123	112	99		
FB8SL/9A + 8F100*	100	75	238	179	173	166	158	150	139	126	112		
FB8SL/10A + 8F125*	125	92	264	199	192	184	176	167	154	140	124		
FB8SL/11A + 8F125*	125	92	290	219	211	202	194	184	169	154	136		
FB8SL/12A + 8F150*	150	110	317	239	230	221	211	200	185	168	149		
FB8SL/13A + 8F150*	150	110	343	259	250	239	229	217	200	182	161		



Dimensioni e pesi

Overall dimensions and weights - Dimensions d'encombrement et poids

Tipo Type Type	Cv Hp	Kw	A (mm)	B (mm)	C (mm)	D (mm)	ø max (mm)	DN	Peso - Weight - Poids		
									A (kg)	B (kg)	C (kg)
FB8SL/1A + 6F12	12,5	9,2	1301	604	697	145			96	42	54
FB8SL/2L + 6F15	15	11	1503	736	767				113	52	61
FB8SL/2G + 6F17	17,5	13	1503	736	767				114	52	62
FB8SL/2F + 6F20	20	15	1563	736	827				120	52	68
FB8SL/2A + 6F25	25	18,5	1633	736	897				127	52	75
FB8SL/3F + 6F30	30	22	1835	868	967				144	62	82
FB8SL/3A + 6F35	35	26	1895	868	1027				151	62	89
FB8SL/4F + 8F40	40	30	2077	1028	1049				213	75	138
FB8SL/4A + 8F50	50	37	2147	1028	1119				228	75	153
FB8SL/5A + 8F60	60	45	2389	1160	1229				256	85	171
FB8SL/6A + 8F70	70	51	2521	1292	1229				267	95	172
FB8SL/7D + 8F75	75	55	2773	1424	1349				289	105	184
FB8SL/7A + 8F80	80	59	2773	1424	1349				289	105	184
FB8SL/8D + 8F85	85	62	2905	1556	1349	299	115	184			
FB8SL/8A + 8F90*	90	66	2975	1556	1419	320	115	205			
FB8SL/9A + 8F100*	100	75	3297	1688	1609	361	125	236			
FB8SL/10A + 8F125*	125	92	3499	1820	1679	373	135	238			
FB8SL/11A + 8F125*	125	92	3631	1952	1679	383	145	238			
FB8SL/12A + 8F150*	150	110	3873	2084	1789	420	155	265			
FB8SL/13A + 8F150*	150	110	4005	2216	1789	430	165	265			

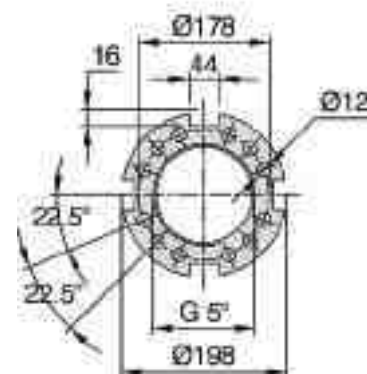

* Non consigliata per montaggio in posizione orizzontale

* This electropump isn't recommended for horizontal assemblage

* Cette électropompe n'est pas recommandée pour le montage en position horizontale

CURVE DELLE PRESTAZIONI

PERFORMANCES' CURVES

COURBES DES PERFORMANCES

FB8SL

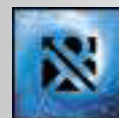

n=2900 1/min 50 Hz

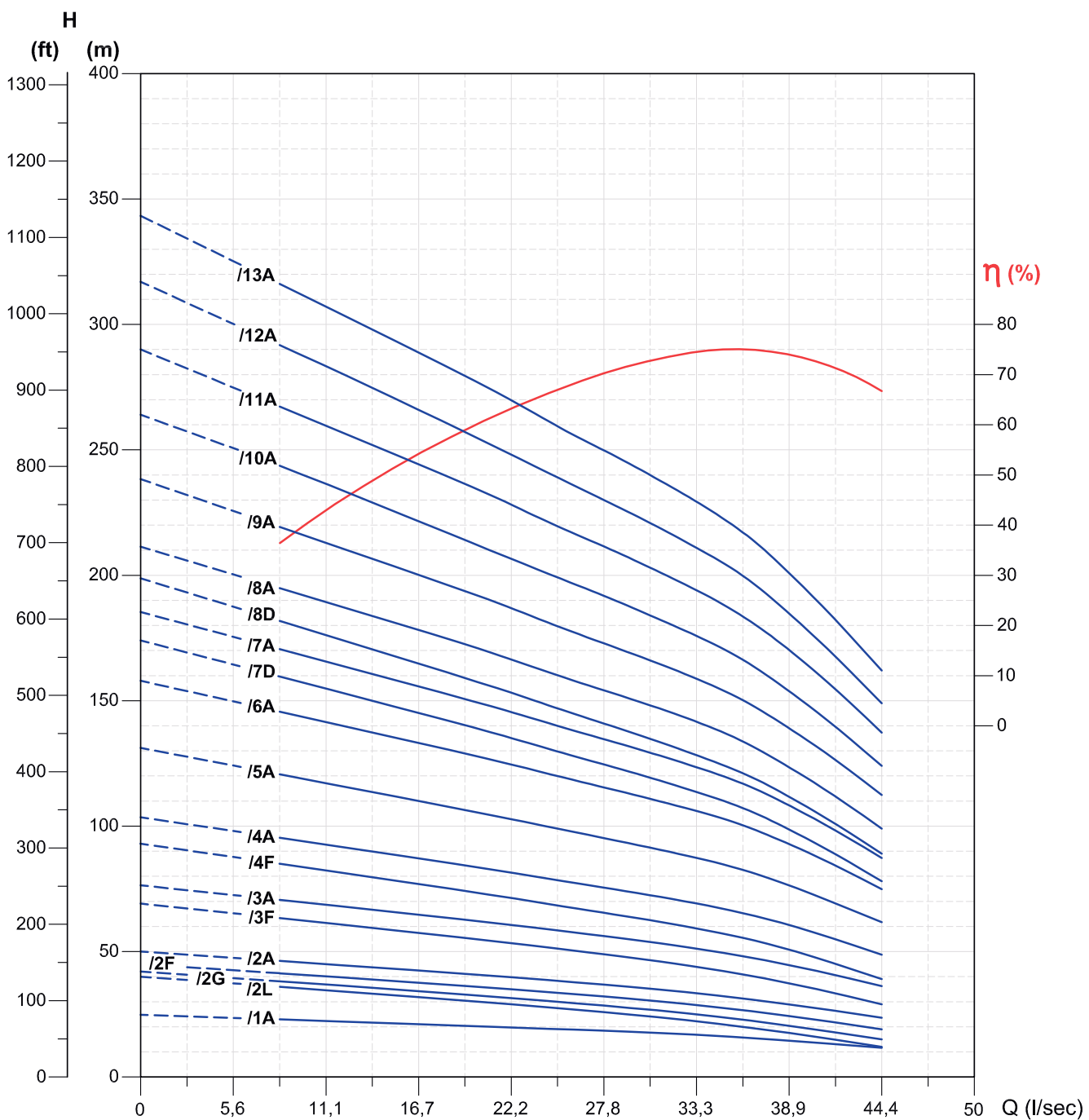

NPSH
(m)

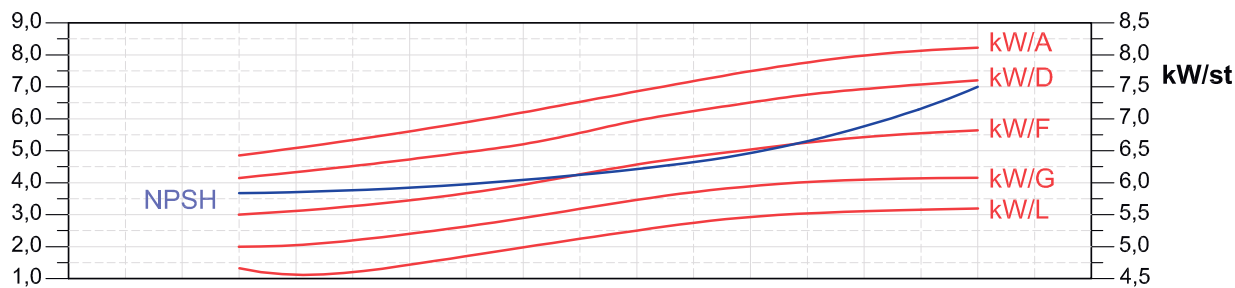

Tolleranze secondo EN ISO 9906 app.A Gr.2 - Tolerances according to EN ISO 9906 anx.A Gr.2 - Tolérances conformes EN ISO 9906 ann.A Gr.2

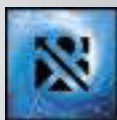

ELETTROPOMPE SOMMERSE 8" SEMIASSIALI IN ACCIAIO INOX AISI 304, AISI 316 E AISI 904L

8" MIXED-FLOW STAINLESS STEEL AISI 304, AISI 316 AND AISI 904L ELECTROPUMPS

ÉLECTROPOMPES IMMERGÉES 8" SEMI-AXIALES EN ACIER INOXYDABLE AISI 304, AISI 316 ET AISI 904L



La struttura totalmente in acciaio inossidabile con camicia esterna, garantisce l'allineamento permanente di tutti i componenti che assieme agli anelli di rasamento flottanti in PTFE, le bocche di guida in ceramica, i cuscinetti scanalati in gomma conferiscono al corpo pompa una maggiore resistenza nel tempo. La gamma è stata studiata per garantire un'elevata efficienza con la riduzione del consumo di energia e quindi dei costi.

APPLICAZIONI:

- irrigazione, approvvigionamento idrico, aumento pressione, ed antincendio
- acque potabili
- acque di mare
- acque salmastre
- acque termali e sulfuree
- desalinizzazione ed osmosi
- acque aggressive e corrosive
- vari settori dell'industria: alimentare, petrolchimica, siderurgica e navale
- applicazioni gravose: miniera

CONSTRUZIONE IN ACCIAIO INOX AISI 304:

- giranti in acciaio inox AISI 304 (W. Nr. 1.4301)
- corpo di stadio in acciaio inox AISI 304 (W. Nr. 1.4301)
- bocca di mandata in acciaio inox AISI 304 (W. Nr. 1.4301)
- valvola di ritegno in acciaio inox AISI 316 (W. Nr. 1.4401)
- albero in acciaio inox AISI 431 (W. Nr. 1.4057)
- proteggi cavo in acciaio inox AISI 316 (W. Nr. 1.4401)
- griglia d'aspirazione in acciaio inox AISI 316 (W. Nr. 1.4401)
- viteria in acciaio inox AISI 304 (W. Nr. 1.4301)

CONSTRUZIONE IN ACCIAIO INOX AISI 316:

- giranti in acciaio inox AISI 316 (W. Nr. 1.4401)
- corpo di stadio in acciaio inox AISI 316 (W. Nr. 1.4401)
- bocca di mandata in acciaio inox AISI 316 (W. Nr. 1.4401)
- valvola di ritegno in acciaio inox AISI 316 (W. Nr. 1.4401)
- albero in acciaio inox AISI 316 (W. Nr. 1.4401)
- proteggi cavo in acciaio inox AISI 316 (W. Nr. 1.4401)
- griglia d'aspirazione in acciaio inox AISI 316 (W. Nr. 1.4401)
- viteria in acciaio inox AISI 316 (W. Nr. 1.4401)

CONSTRUZIONE IN ACCIAIO INOX AISI 904L:

- giranti in acciaio inox AISI 904L (W. Nr. 1.4539)
- corpo di stadio in acciaio inox AISI 904L (W. Nr. 1.4539)
- bocca di mandata in acciaio inox AISI 904L (W. Nr. 1.4517)
- valvola di ritegno in acciaio inox AISI 2205 (W. Nr. 1.4462)
- albero in acciaio inox AISI 329 (W. Nr. 1.4460)
- proteggi cavo in acciaio inox AISI 904L (W. Nr. 1.4539)
- griglia d'aspirazione in acciaio inox AISI 904L (W. Nr. 1.4539)
- viteria in acciaio inox AISI 904L / AISI 329 (W. Nr. 1.4539 / W. Nr. 1.4460)

CARATTERISTICHE:

- portata massima: 2000 l/m
- prevalenza massima: 507 metri
- potenza massima: 110 kW
- diametro d'ingombro massimo: 192 mm (incluso il copri cavo)
- temperatura massima dell'acqua: 60°C (solo per corpo pompa, per il motore vedi catalogo motori)
- contenuto di sabbia massimo: 100 g/m³

OPTIONAL:

- Su richiesta si possono fornire:
- doppio proteggi cavo
 - attacco motore 6" NEMA
 - attacco motore 8" NEMA



The stainless steel construction with external sleeve, assure permanent alignment of all the components together with PTFE floating neck ring, ceramic guide journal sleeve and nitrile rubber fluted bearing to ensure the pump long-lasting performances.

This range is studied to ensure efficiency at the top of the market, thus reducing energy consumption and costs.

APPLICATIONS:

- irrigation, water supply system, pressure boosting, fire-fighting systems
- drinking water
- sea water
- brackish water
- thermal and sulphurous water
- desalinization and osmosis
- aggressive and corrosive waters
- different sectors of the industry: such as food, petrochemical, steel and shipbuilding
- hard applications: mine

STAINLESS STEEL AISI 304 CONSTRUCTION:

- stainless steel AISI 304 (W. Nr. 1.4301) impellers
- stainless steel AISI 304 (W. Nr. 1.4301) diffusers
- stainless steel AISI 304 (W. Nr. 1.4301) discharge head
- stainless steel AISI 316 (W. Nr. 1.4401) retaining valve
- stainless steel AISI 431 (W. Nr. 1.4057) shaft
- stainless steel AISI 316 (W. Nr. 1.4401) cable guard
- stainless steel AISI 316 (W. Nr. 1.4401) suction strainer
- stainless steel AISI 304 (W. Nr. 1.4301) bolts and screws

STAINLESS STEEL AISI 316 CONSTRUCTION:

- stainless steel AISI 316 (W. Nr. 1.4401) impellers
- stainless steel AISI 316 (W. Nr. 1.4401) diffusers
- stainless steel AISI 316 (W. Nr. 1.4401) discharge head
- stainless steel AISI 316 (W. Nr. 1.4401) retaining valve
- stainless steel AISI 316 (W. Nr. 1.4401) shaft
- stainless steel AISI 316 (W. Nr. 1.4401) cable guard
- stainless steel AISI 316 (W. Nr. 1.4401) suction strainer
- stainless steel AISI 316 (W. Nr. 1.4301) bolts and screws

STAINLESS STEEL AISI 904L CONSTRUCTION:

- stainless steel AISI 904L (W. Nr. 1.4539) impellers
- stainless steel AISI 904L (W. Nr. 1.4539) diffusers
- stainless steel AISI 904L (W. Nr. 1.4517) discharge head
- stainless steel AISI 2205 (W. Nr. 1.4462) retaining valve
- stainless steel AISI 329 (W. Nr. 1.4460) shaft
- stainless steel AISI 904L (W. Nr. 1.4539) cable guard
- stainless steel AISI 904L (W. Nr. 1.4539) suction strainer
- stainless steel AISI 904L / AISI 329 (W. Nr. 1.4539 / W. Nr. 1.4460) bolts and screws

FEATURES:

- maximum capacity: 2000 l/m
- maximum head: 507 meters
- maximum power: 110 Kw
- maximum encumbrance diameter: 192 mm (cable cover included)
- maximum water temperature: 60°C (only for the pump, for the motor see motors' catalogue)
- maximum sand content: 100 g/m³

OPTIONAL:

- On demand pumps can be supplied with:
- double cable guard
 - 6" NEMA coupling
 - 8" NEMA coupling

ELETTROPOMPE SOMMERSE 8" SEMIASSIALI IN ACCIAIO INOX AISI 304, AISI 316 E AISI 904L

8" MIXED-FLOW STAINLESS STEEL AISI 304, AISI 316 AND AISI 904L ELECTROPUMPS

ÉLECTROPOMPES IMMERGÉES 8" SEMI-AXIALES EN ACIER INOXYDABLE AISI 304, AISI 316 ET AISI 904L

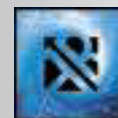

La structure en acier inoxydable avec la chemise externe, garantit l'alignement permanent de tous les composants et avec les bagues d'usure flottantes en PTFE, les douilles de guidage en céramique et les coussinets rainurés en caoutchouc confèrent à la pompe plus résistance dans les temps.

La gamme a été étudiée pour garantir haute efficacité en réduisant la consommation d'énergie et donc des coûts.

APPLICATIONS:

- irrigation, installation d'approvisionnement hydrique, surpression et anti incendie
- eau potable
- eau de mer
- eau saumâtre
- eau thermale e sulfureuse
- dessalement et osmose
- eau agressive et corrosives
- différents secteurs de l'industrie: alimentaire, pétrochimie, sidérurgique et navale
- applications dures: mine

CONSTRUCTION EN AISI 304:

- roues en acier inoxydable AISI 304 (W. Nr. 1.4301)
- corps d'étage en acier inoxydable AISI 304 (W. Nr. 1.4301)
- orifice de refoulement en acier inoxydable AISI 304 (W. Nr. 1.4301)
- crépine de non-retour en acier inoxydable AISI 316 (W. Nr. 1.4401)
- arbre en acier inoxydable AISI 431 (W. Nr. 1.4057)
- couvre-câble en acier inoxydable AISI 316 (W. Nr. 1.4401)
- crépine d'aspiration en acier inoxydable AISI 316 (W. Nr. 1.4401)
- visserie en acier inoxydable AISI 304 (W. Nr. 1.4301)

CONSTRUCTION EN AISI 316:

- roues en acier inoxydable AISI 316 (W. Nr. 1.4401)
- corps d'étage en acier inoxydable AISI 316 (W. Nr. 1.4401)
- orifice de refoulement en acier inoxydable AISI 316 (W. Nr. 1.4401)
- crépine de non-retour en acier inoxydable AISI 316 (W. Nr. 1.4401)
- arbre en acier inoxydable AISI 316 (W. Nr. 1.4401)
- couvre-câble en acier inoxydable AISI 316 (W. Nr. 1.4401)
- crépine d'aspiration en acier inoxydable AISI 316 (W. Nr. 1.4401)
- visserie en acier inoxydable AISI 316 (W. Nr. 1.4401)

CONSTRUCTION EN ACIER INOX AISI 904L:

- roues en acier inoxydable AISI 904L (W. Nr. 1.4539)
- corps d'étage en acier inoxydable AISI 904L (W. Nr. 1.4539)
- orifice de refoulement en acier inoxydable AISI 904L (W. Nr. 1.4517)
- crépine de non-retour en acier inoxydable AISI 2205 (W. Nr. 1.4462)
- arbre en acier inoxydable AISI 329 (W. Nr. 1.4460)
- couvre-câble en acier inoxydable AISI 904L (W. Nr. 1.4539)
- crépine d'aspiration en acier inoxydable AISI 904L (W. Nr. 1.4539)
- visserie en acier inoxydable AISI 904L / AISI 329 (W. Nr. 1.4539 / W. Nr. 1.4460)

CARACTÉRISTIQUES:

- débit maximum: 2000 l/m
- hauteur maximale: 507 mètres
- puissance maximale: 110 Kw
- diamètre d'encombrement maximum: 192 mm (inclus le couvre-câble)
- température maximale de l'eau: 60°C (pour la pompe, pour le moteur voir le catalogue des moteurs)
- quantité maximale de sable: 100 g/m³

OPTIONAL:

- Sur demande on peut fournir:
- double couvre-câble
 - accouplement moteur 6" NEMA
 - accouplement moteur 8" NEMA



NEW

AISI 304
AISI 316
AISI 904L



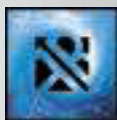

ACCOPIAMENTO MOTORE 6"
6" MOTOR COUPLINGS
ACCOUPEMENTS MOTEUR 6"

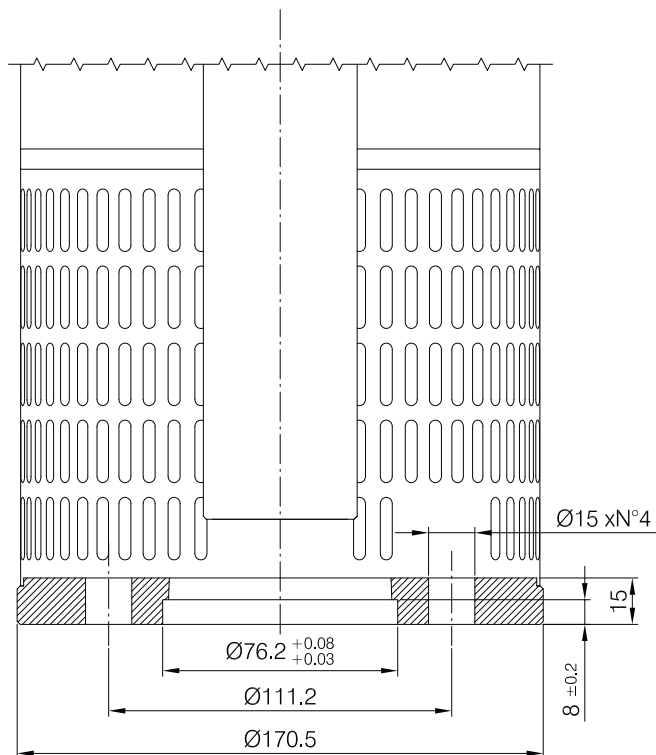

ACCOPIAMENTO MOTORE 8"
8" MOTOR COUPLINGS
ACCOUPEMENTS MOTEUR 8"

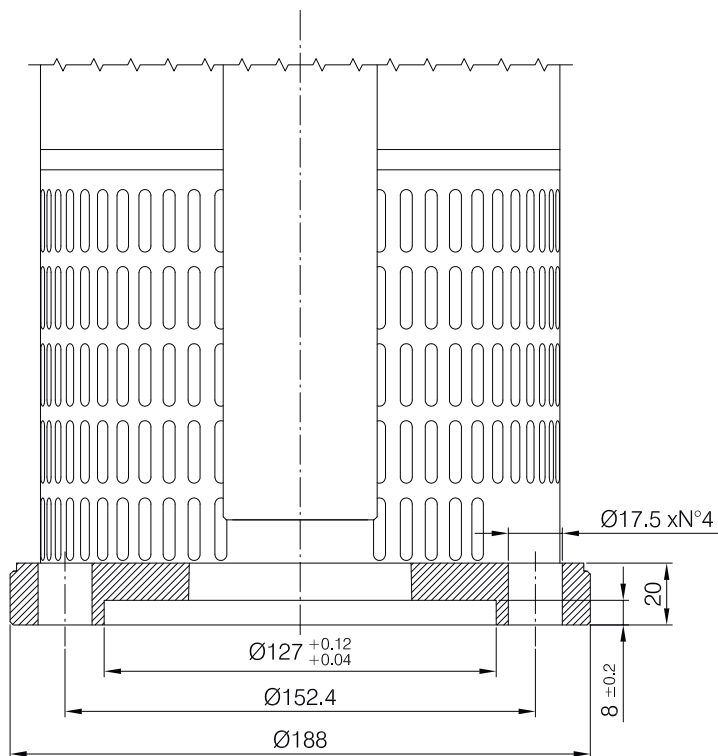

SPACCATO 8"

8" CUTAWAY

COUPE 8"

FB8SX

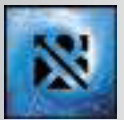

N°	Versione Version Version	AISI 304	AISI 316	AISI 904L
1	Corpo di mandata Discharge head Refolement	AISI 304	AISI 316	AISI 904L
2	Valvola Valve Soupape	AISI 316	AISI 316	AISI 2205
3	Anello tenuta OR O.R. ring Bague O.R.	NBR	NBR	NBR
4	Viti e dadi esterni Outer case locking nuts Vis et écrous externes	AISI 304	AISI 316	AISI 2205/904L
5	Supporto valvola Valve support Support de la valve	AISI 316	AISI 316	AISI 2205
6	Anello seeger Circlip Segment d'arrête	AISI 316	AISI 316	AISI 904L
7	Molla Spring Ressort	AISI 316	AISI 316	AISI 2205
8	Camicia esterna Sleeve Chemise	AISI 304	AISI 316	AISI 2205
9	Griglia di aspirazione Suction strainer Crépine d'aspiration	AISI 316	AISI 316	AISI 904L
10	Copricavo e viti Cable guard Protège cable	AISI 304	AISI 316	AISI 904L
11	Distanziale iniziale Initial spacer Entrotoise	AISI 304	AISI 316	AISI 904L
12	Flangia e bulloni Flange and screws Flange et boulon	AISI 304	AISI 316	AISI 904L
13	Supporto di aspirazione Suction support Support d'Aspiration	AISI 431	AISI 316/329	AISI 329
14	Albero pompa Pump shaft Arbre de pompe	AISI 431/329	AISI 316/329	AISI 904L/329
15	Giunto Joint Joint	AISI 316	AISI 316	AISI 329
16	Disco reggispinta sup. Upper thrust washer Butée supérieure	AISI 316	AISI 316	AISI 329
17	Disco reggispinta inf. Lower thrust washer Butée inférieure	AISI 329	AISI 329	AISI 329
18	Cuscinetto a boccola Bearing bush Cousinnet	PTFE + grafite PTFE + graphite PTFE + graphite	PTFE + grafite PTFE + graphite PTFE + graphite	PTFE + grafite PTFE + graphite PTFE + graphite
19	Vite e rondella Screw and washer Vis et rondelle	AISI 316	AISI 316	AISI 904L
20	Anello reggispinta Thrust ring Bague de butée	NBR	NBR	NBR
21	Diffusore Diffuser Diffuseur	AISI 304	AISI 316	AISI 904L
22	Bussola intermedia Intermediate bush Duille intermédiaire	PTFE	PTFE	PTFE
23	Anello rasamento flottante Floating neck ring Bague d'usure flottant	NBR	NBR	NBR
24	Anello rasamento blocc. Blocking neck ring Bague d'usure bloquant	AISI 316	AISI 316	-
25	Girante Impeller Roue	AISI 304	AISI 316	AISI 904L
26	Cono elastico Split cone Cône élastique	AISI 316	AISI 316	AISI 316
27	Dado cono elastico Split cone nut Écrou cône élastique	AISI 316	AISI 316	AISI 329

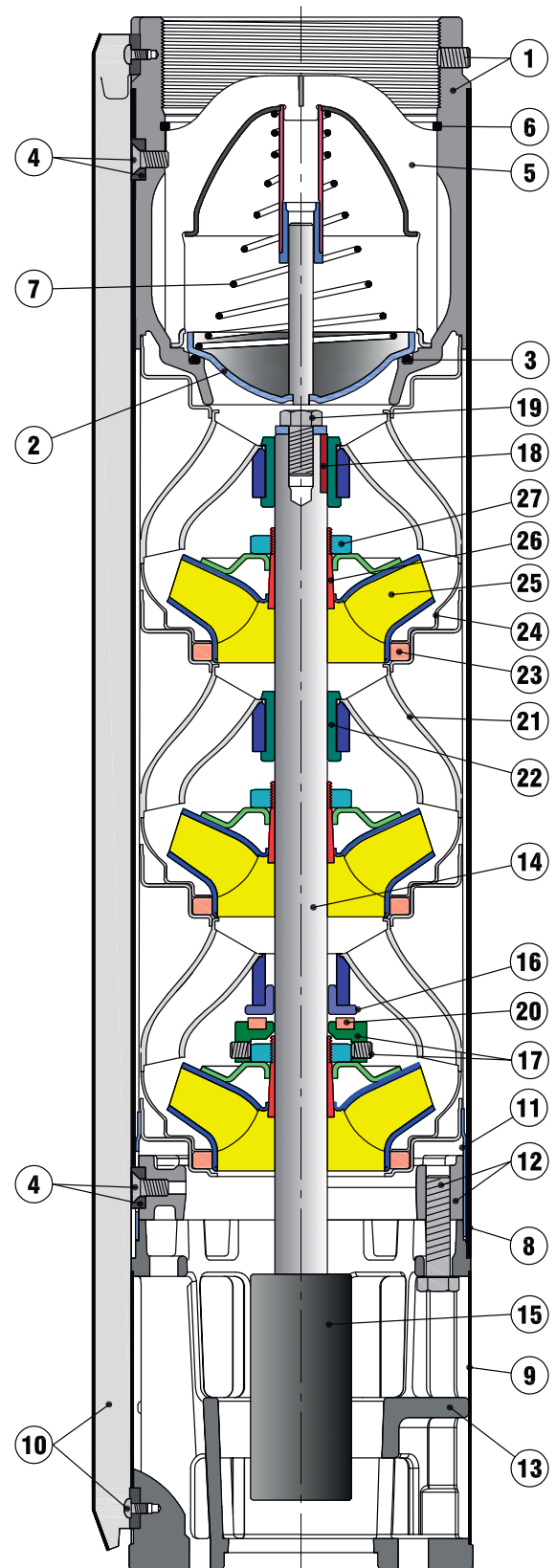



TABELLA DELLE CARATTERISTICHE IDRAULICHE 8"

8" HYDRAULIC FEATURES' CHART

TABLE DES CARACTÉRISTIQUES HYDRAULIQUES 8"

Tipo Type Type	Motore Motor Moteur		Q = Portata - Capacity - Débit															
			l/sec	0	5,6	8,3	11,1	13,9	16,7	19,4	22,2	25,0	27,8					
	l/min	0	333	500	667	833	1000	1167	1333	1500	1667							
	Hp	kW	mc/h	0	20	30	40	50	60	70	80	90	100					
FB8SX80/1	5,5	4		20		19	18	16	15	14	12	10	9					
FB8SX80/2	10	7,5		40		38	35	32	30	29	24	20	18					
FB8SX80/3	15	11		60		55	51	49	45	41	36	30	24					
FB8SX80/4	20	15		80		74	70	65	60	55	49	41	32					
FB8SX80/5	25	18,5		99		92	88	81	75	69	60	51	41					
FB8SX80/6	30	22		119		110	104	98	89	81	71	60	49					
FB8SX80/7	35	26		139		130	122	114	105	96	85	72	58					
FB8SX80/8	40	30		159		149	140	131	120	110	98	82	67					
FB8SX80/9	40	30		180		168	158	147	135	123	110	92	73					
FB8SX80/10	50	37		197		183	172	160	148	134	119	100	79					
FB8SX80/11	50	37		216		202	190	176	162	148	130	110	87					
FB8SX80/12	60	45		248		232	219	205	189	172	153	131	106					
FB8SX80/13	70	51	H(m)	269		252	237	221	205	188	168	142	115					
FB8SX80/14	70	51		289		271	256	239	220	201	180	153	123					
FB8SX80/15	75	55		309		290	274	255	235	215	192	165	132					
FB8SX80/16	80	59		332		311	294	275	252	231	208	177	143					
FB8SX80/17	85	62		352		330	312	291	269	246	220	188	151					
FB8SX80/18	90	66		373		350	330	309	284	260	232	198	161					
FB8SX80/19	90	66		394		370	348	325	300	275	245	210	170					
FB8SX80/20	100	75		415		389	368	343	316	290	259	220	179					
FB8SX80/21	100	75		436		409	385	360	331	304	271	231	189					
FB8SX80/22	125	92		457		428	404	378	347	320	284	243	198					
FB8SX80/23	125	92		478		446	421	394	362	332	297	254	207					
FB8SX80/24	125	92		498		467	440	411	379	348	310	265	216					

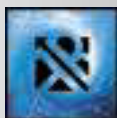
TABELLA DELLE CARATTERISTICHE IDRAULICHE 8"

8" HYDRAULIC FEATURES' CHART

TABLE DES CARACTÉRISTIQUES HYDRAULIQUES 8"

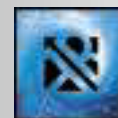

n=2900 1/min 50 Hz

Tipo Type Type	Motore Motor Moteur		Q = Portata - Capacity - Débit																
			l/sec	0	5,6	8,3	11,1	13,9	16,7	19,4	22,2	25,0	27,8	30,6	33,3				
	l/min	0	333	500	667	833	1000	1167	1333	1500	1667	1833	2000						
	Hp	kW	mc/h	0	20	30	40	50	60	70	80	90	100	110	120				
FB8SX95/1	7,5	5,5		21			20	18	16	15	15	13	11	10	8				
FB8SX95/2	12,5	9,2		42			39	36	32	30	29	26	22	19	15				
FB8SX95/3	17,5	13		63			58	53	49	45	42	39	33	29	21				
FB8SX95/4	25	18,5		84			77	71	65	60	57	51	45	38	30				
FB8SX95/5	30	22		104			95	88	80	74	70	62	55	46	37				
FB8SX95/6	35	26		127			115	107	98	90	84	77	68	57	46				
FB8SX95/7	40	30		148			135	123	115	106	99	90	79	68	52				
FB8SX95/8	50	37		168			151	140	130	120	110	100	89	74	59				
FB8SX95/9	50	37		188			170	158	147	133	124	113	99	83	66				
FB8SX95/10	60	45		219			200	185	172	159	148	137	120	103	82				
FB8SX95/11	70	51		241			220	204	189	175	162	149	132	113	91				
FB8SX95/12	70	51	H(m)	262			240	221	207	191	178	162	143	123	99				
FB8SX95/13	75	55		284			260	241	223	207	191	177	155	132	108				
FB8SX95/14	80	59		309			282	261	242	226	209	191	169	145	121				
FB8SX95/15	90	66		330			303	280	260	240	222	205	181	155	130				
FB8SX95/16	100	75		352			322	299	279	258	238	220	194	165	139				
FB8SX95/17	100	75		373			342	319	294	272	252	232	207	176	147				
FB8SX95/18	125	92		398			363	337	313	289	268	247	219	188	155				
FB8SX95/19	125	92		419			382	354	330	305	282	260	230	197	164				
FB8SX95/20	125	92		440			404	372	347	320	298	273	241	208	171				
FB8SX95/21	125	92		462			422	391	363	337	312	289	255	219	180				
FB8SX95/22	150	110		484			442	410	381	353	328	301	267	229	190				
FB8SX95/23	150	110		507			463	430	399	370	341	315	279	239	199				

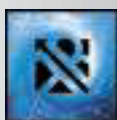

FB8SX80

DATI DELLE PRESTAZIONI
PERFORMANCES' DATA
DONNÉES DES PERFORMANCES

Tipo Type Type	Motore Motors 2900 g/m Moteurs		Q = Portata - Capacity - Débit									
	Cv Hp	Kw	l/sec	0	8,3	11,1	13,9	16,7	19,4	22,2	25,0	27,8
			l/min	0	500	667	833	1000	1167	1333	1500	1667
			mc/h	0	30	40	50	60	70	80	90	100
FB8SX80/1 + 6F5	5,5	4	H(m)	20	19	18	16	15	14	12	10	9
FB8SX80/2 + 6F10	10	7,5		40	38	35	32	30	29	24	20	18
FB8SX80/3 + 6F15	15	11		60	55	51	49	45	41	36	30	24
FB8SX80/4 + 6F20	20	15		80	74	70	65	60	55	49	41	32
FB8SX80/5 + 6F25	25	18,5		99	92	88	81	75	69	60	51	41
FB8SX80/6 + 6F30	30	22		119	110	104	98	89	81	71	60	49
FB8SX80/7 + 6F35	35	26		139	130	122	114	105	96	85	72	58
FB8SX80/8 + 8F40	40	30		159	149	140	131	120	110	98	82	67
FB8SX80/9 + 8F40	40	30		180	168	158	147	135	123	110	92	73
FB8SX80/10 + 8F50	50	37		197	183	172	160	148	134	119	100	79
FB8SX80/11 + 8F50	50	37		216	202	190	176	162	148	130	110	87
FB8SX80/12 + 8F60	60	45		248	232	219	205	189	172	153	131	106
FB8SX80/13 + 8F70	70	51		269	252	237	221	205	188	168	142	115
FB8SX80/14 + 8F70	70	51		289	271	256	239	220	201	180	153	123
FB8SX80/15 + 8F75	75	55		309	290	274	255	235	215	192	165	132
FB8SX80/16 + 8F80	80	59		332	311	294	275	252	231	208	177	143
FB8SX80/17 + 8F85	85	62		352	330	312	291	269	246	220	188	151
FB8SX80/18 + 8F90*	90	66		373	350	330	309	284	260	232	198	161
FB8SX80/19 + 8F90*	90	66		394	370	348	325	300	275	245	210	170
FB8SX80/20 + 8F100*	100	75		415	389	368	343	316	290	259	220	179
FB8SX80/21 + 8F100*	100	75		436	409	385	360	331	304	271	231	189
FB8SX80/22 + 8F125*	125	92		457	428	404	378	347	320	284	243	198
FB8SX80/23 + 8F125*	125	92		478	446	421	394	362	332	297	254	207
FB8SX80/24 + 8F125*	125	92		498	467	440	411	379	348	310	265	216

Dimensioni e pesi

Overall dimensions and weights - Dimensions d'encombrement et poids

Tipo Type Type	Cv Hp	Kw	A (mm)	B (mm)	C (mm)	D (mm)	ø max (mm)	DN	Peso - Weight - Poids		
									A (kg)	B (kg)	C (kg)
									FB8SX80/1 + 6F5	5,5	4
FB8SX80/2 + 6F10	10	7,5	1311	644	667	80	30	50			
FB8SX80/3 + 6F15	15	11	1467	770	697	96	35	61			
FB8SX80/4 + 6F20	20	15	1723	896	827	107	39	68			
FB8SX80/5 + 6F25	25	18,5	1919	1022	897	119	44	75			
FB8SX80/6 + 6F30	30	22	2115	1148	967	131	49	82			
FB8SX80/7 + 6F35	35	26	2301	1274	1027	142	53	89			
FB8SX80/8 + 8F40	40	30	2449	1400	1049	155	57	96			
FB8SX80/9 + 8F40	40	30	2575	1526	1049	168	65	103			
FB8SX80/10 + 8F50	50	37	2771	1652	1119	181	70	110			
FB8SX80/11 + 8F50	50	37	2897	1778	1119	194	74	117			
FB8SX80/12 + 8F60	60	45	3138	1909	1229	207	79	124			
FB8SX80/13 + 8F70	70	51	3264	2035	1229	220	84	131			
FB8SX80/14 + 8F70	70	51	3390	2161	1229	233	88	138			
FB8SX80/15 + 8F75	75	55	3636	2287	1349	246	93	145			
FB8SX80/16 + 8F80	80	59	3762	2413	1349	259	98	152			
FB8SX80/17 + 8F85	85	62	3888	2539	1349	272	102	159			
FB8SX80/18 + 8F90*	90	66	4084	2665	1419	285	107	166			
FB8SX80/19 + 8F90*	90	66	4210	2791	1419	298	111	173			
FB8SX80/20 + 8F100*	100	75	4526	2917	1609	311	116	180			
FB8SX80/21 + 8F100*	100	75	4652	3043	1609	324	121	187			
FB8SX80/22 + 8F125*	125	92	4848	3169	1679	337	125	194			
FB8SX80/23 + 8F125*	125	92	4974	3295	1679	350	130	201			
FB8SX80/24 + 8F125*	125	92	5100	3421	1679	363	134	208			



* Non consigliata per montaggio in posizione orizzontale

* This electropump isn't recommended for horizontal assemblage

* Cette électropompe n'est pas recommandée pour le montage en position horizontale

CURVE DELLE PRESTAZIONI

PERFORMANCES' CURVES

COURBES DES PERFORMANCES

FB8SX80

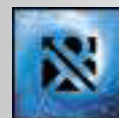

n=2900 1/min 50 Hz

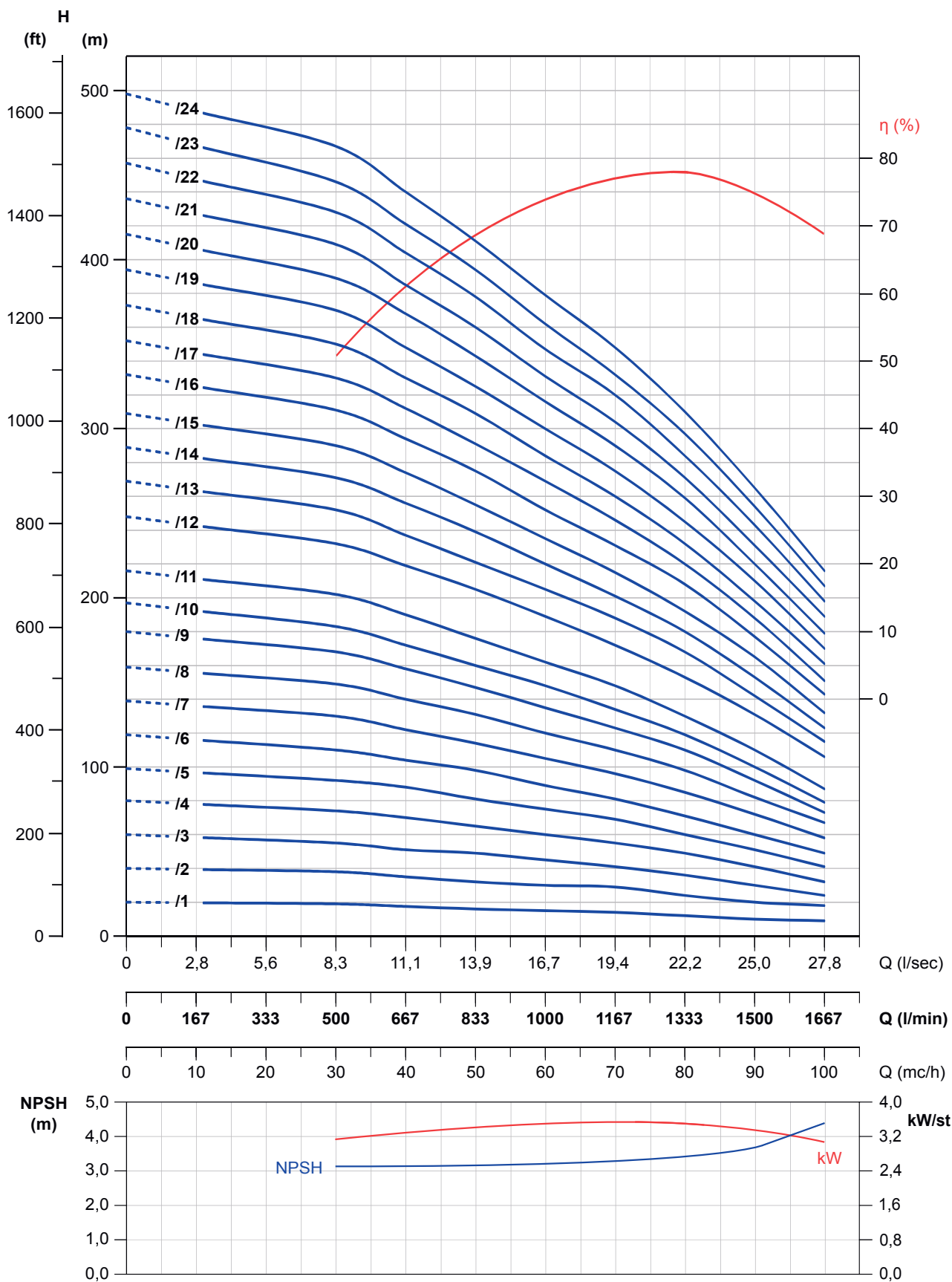

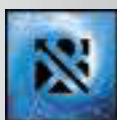

Tipo Type Type	Motore Motors 2900 g/m Moteurs		Q = Portata - Capacity - Débit										
	Cv Hp	Kw	l/sec	0	13,9	16,7	19,4	22,2	25,0	27,8	30,6	33,3	
			l/min	0	833	1000	1167	1333	1500	1667	1833	2000	
			mc/h	0	50	60	70	80	90	100	110	120	
FB8SX95/1 + 6F7	7,5	5,5	H(m)	21	18	16	15	15	13	11	10	8	
FB8SX95/2 + 6F12	12,5	9,2		42	36	32	30	29	26	22	19	15	
FB8SX95/3 + 6F17	17,5	13		63	53	49	45	42	39	33	29	21	
FB8SX95/4 + 6F25	25	18,5		84	71	65	60	57	51	45	38	30	
FB8SX95/5 + 6F30	30	22		104	88	80	74	70	62	55	46	37	
FB8SX95/6 + 6F35	35	26		127	107	98	90	84	77	68	57	46	
FB8SX95/7 + 8F40	40	30		148	123	115	106	99	90	79	68	52	
FB8SX95/8 + 8F50	50	37		168	140	130	120	110	100	89	74	59	
FB8SX95/9 + 8F50	50	37		188	158	147	133	124	113	99	83	66	
FB8SX95/10 + 8F60	60	45		219	185	172	159	148	137	120	103	82	
FB8SX95/11 + 8F70	70	51		241	204	189	175	162	149	132	113	91	
FB8SX95/12 + 8F70	70	51		262	221	207	191	178	162	143	123	99	
FB8SX95/13 + 8F75	75	55		284	241	223	207	191	177	155	132	108	
FB8SX95/14 + 8F80	80	59		309	261	242	226	209	191	169	145	121	
FB8SX95/15 + 8F90*	90	66		330	280	260	240	222	205	181	155	130	
FB8SX95/16 + 8F100*	100	75		352	299	279	258	238	220	194	165	139	
FB8SX95/17 + 8F100*	100	75		373	319	294	272	252	232	207	176	147	
FB8SX95/18 + 8F125*	125	92		398	337	313	289	268	247	219	188	155	
FB8SX95/19 + 8F125*	125	92		419	354	330	305	282	260	230	197	164	
FB8SX95/20 + 8F125*	125	92		440	372	347	320	298	273	241	208	171	
FB8SX95/21 + 8F125*	125	92		462	391	363	337	312	289	255	219	180	
FB8SX95/22 + 8F150*	150	110		484	410	381	353	328	301	267	229	190	
FB8SX95/23 + 8F150*	150	110		507	430	399	370	341	315	279	239	199	

Dimensioni e pesi

Overall dimensions and weights - Dimensions d'encombrement et poids

Tipo Type Type	Cv Hp	Kw	A (mm)	B (mm)	C (mm)	D (mm)	ø max (mm)	DN	Peso - Weight - Poids		
									A (kg)	B (kg)	C (kg)
FB8SX95/1 + 6F7	7,5	5,5	1145	518	627	145	188	G 5"	73	27	46
FB8SX95/2 + 6F12	12,5	9,2	1341	644	697				84	30	54
FB8SX95/3 + 6F17	17,5	13	1537	770	767				97	35	62
FB8SX95/4 + 6F25	25	18,5	1793	896	897				114	39	75
FB8SX95/5 + 6F30	30	22	1989	1022	967				126	44	82
FB8SX95/6 + 6F35	35	26	2175	1148	1027				138	49	89
FB8SX95/7 + 8F40	40	30	2323	1274	1049				194	56	138
FB8SX95/8 + 8F50	50	37	2519	1400	1119				213	60	153
FB8SX95/9 + 8F50	50	37	2645	1526	1119				218	65	153
FB8SX95/10 + 8F60	60	45	2886	1657	1229				241	70	171
FB8SX95/11 + 8F70	70	51	3012	1783	1229				246	74	172
FB8SX95/12 + 8F70	70	51	3138	1909	1229				251	79	172
FB8SX95/13 + 8F75	75	55	3384	2035	1349	268	84	184			
FB8SX95/14 + 8F80	80	59	3510	2161	1349	272	88	184			
FB8SX95/15 + 8F90*	90	66	3706	2287	1419	298	93	205			
FB8SX95/16 + 8F100*	100	75	4022	2413	1609	334	98	236			
FB8SX95/17 + 8F100*	100	75	4148	2539	1609	338	102	236			
FB8SX95/18 + 8F125*	125	92	4344	2665	1679	345	107	238			
FB8SX95/19 + 8F125*	125	92	4470	2791	1679	349	111	238			
FB8SX95/20 + 8F125*	125	92	4596	2917	1679	354	116	238			
FB8SX95/21 + 8F125*	125	92	4722	3043	1679	359	121	238			
FB8SX95/22 + 8F150*	150	110	5048	3169	1879	390	125	265			
FB8SX95/23 + 8F150*	150	110	5174	3295	1879	395	130	265			



* Non consigliata per montaggio in posizione orizzontale

* This electropump isn't recommended for horizontal assemblage

* Cette électropompe n'est pas recommandée pour le montage en position horizontale

CURVE DELLE PRESTAZIONI

PERFORMANCES' CURVES

COURBES DES PERFORMANCES

FB8SX95

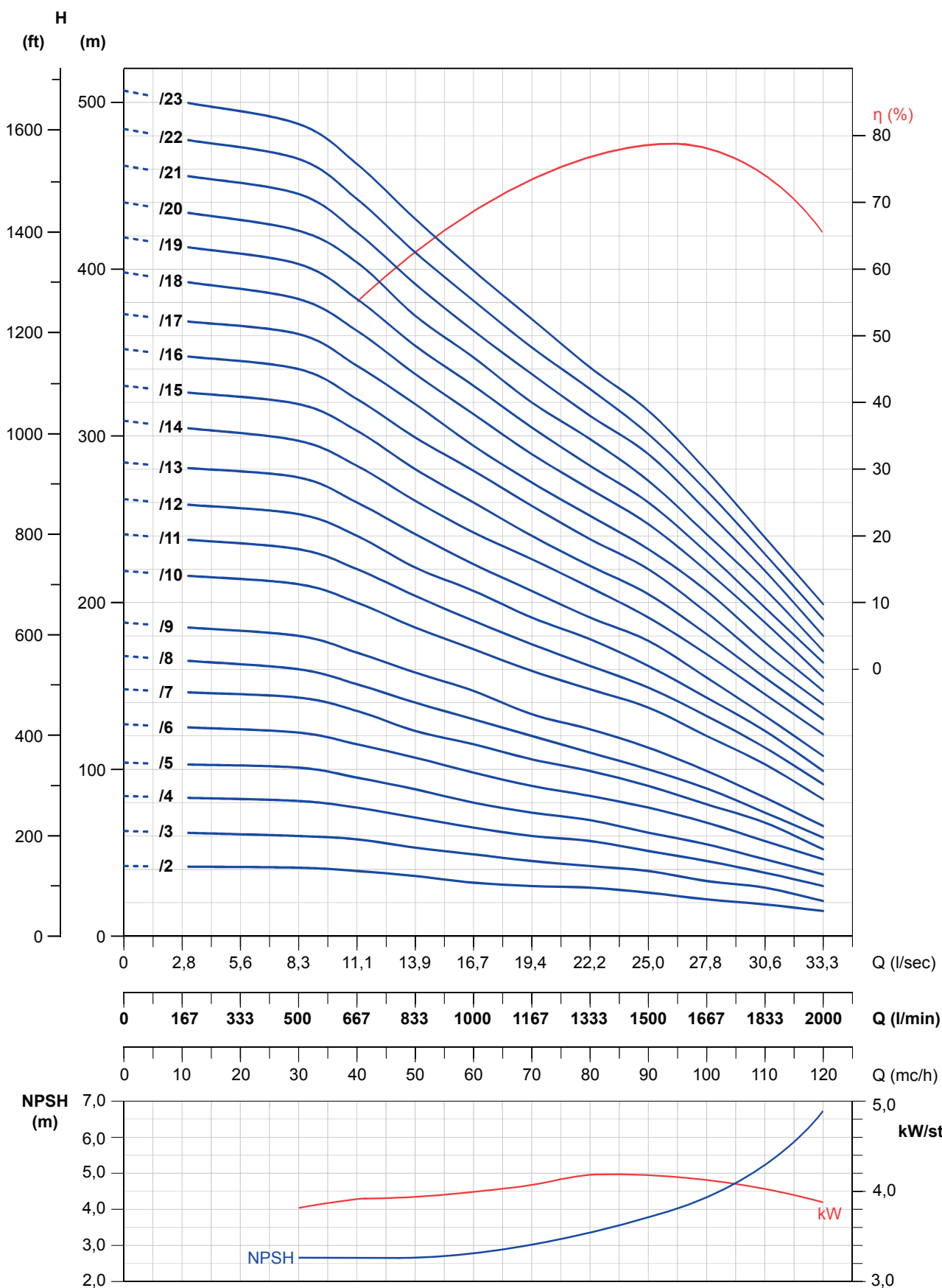
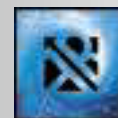

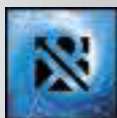

ELETTROPOMPE SOMMERSE 10" RADIALI IN GHISA

10" CAST IRON RADIAL-FLOW SUBMERSIBLE ELECTROPUMPS

ÉLECTROPOMPES IMMERGÉES 10" RADIALES EN FONTE



I corpi pompa 10" di tipo radiale in ghisa, serie FB10R, sono per acque pulite per pozzi 10" DN 250.

La particolarità delle pompe di tipo radiale è la costruzione a stadi di limitato ingombro assiale, tale particolarità consente di ottenere prevalenze elevate con portate medio - basse.

La robustezza di questa serie è data anche dalla costruzione delle giranti in ghisa, che consente l'installazione della pompa in pozzi profondi garantendo massima sicurezza dell'impianto e generando elevati rendimenti.

APPLICAZIONI:

- irrigazione
- approvvigionamento idrico
- aumento pressione
- antincendio

COSTRUZIONE:

- giranti in ghisa G25
- corpo di stadio in ghisa G25
- bocca di mandata in ghisa G25
- valvola di ritegno in ghisa G25
- albero in acciaio inox AISI 420
- proteggi cavo in acciaio inox AISI 304
- griglia d'aspirazione in acciaio inox AISI 304
- viteria in acciaio inox AISI 304

CARATTERISTICHE:

- portata massima: 2167 l/m
- prevalenza massima: 649 metri
- potenza massima: 150 Kw
- diametro d'ingombro massimo: 242 mm (incluso il copri cavo)
- temperatura massima dell'acqua: 60°C (solo per corpo pompa, per il motore vedi catalogo motori)
- contenuto di sabbia massimo: 30 g/m³

OPTIONAL:

Su richiesta si possono fornire corpi pompa in ghisa:

- con sole giranti in bronzo GCuSn10 (B10)
- con sole giranti in acciaio inox AISI 316



10" cast iron radial - flow pumps, range FB10R, are for clean water for 10" wells DN 250.

The peculiarity of the radial - flow pumps is the stage construction with limited axial dimension, this peculiarity allows to reach high head with small and medium capacity.

The sturdiness of this range is given by the cast iron impellers, they permit the installation of the pump in deep wells granting the maximum safety to the system and producing high performances.

APPLICATIONS:

- irrigation
- water supply system
- pressure boosting
- fire-fighting systems

CONSTRUCTION:

- cast iron G25 impellers
- cast iron G25 delivery bowl
- cast iron G25 pump body
- cast iron G25 non-return valve
- stainless steel AISI 420 shaft
- stainless steel AISI 304 cable cover
- stainless steel AISI 304 suction strainer
- stainless steel AISI 304 nuts, bolts and screws

FEATURES:

- maximum capacity: 2167 l/m
- maximum head: 649 meters
- maximum power: 150 kW
- maximum encumbrance diameter: 242 mm (cable cover included)
- maximum water temperature: 60°C (only for the pump, for the motor see motors' catalogue)
- maximum sand content: 30 g/m³

OPTIONAL:

On demand cast iron pumps can be manufactured with:

- bronze GCuSn10 (B10) impellers
- stainless steel AISI 316 impellers



Les pompes immergées 10" du type radiale en fonte, série FB10R, sont pour eaux propres pour puits de 10" DN 250. La particularité des pompes du type radiale est la construction par des stades d'encombrement axial limité, il permet d'obtenir des hauteurs élevées avec des bas et moyens débits. La solidité de cette gamme de pompes est donnée par la construction des roues en fonte, qui permet l'installation de la pompe dans puits profonds en garantissant sûreté maximale de l'installation et en engendrant hautes performances.

APPLICATIONS:

- irrigation
- installation d'approvisionnement hydrique
- surpression
- anti incendie

CONSTRUCTION:

- roues en fonte G25
- corps d'étage en fonte G25
- orifice de refoulement en fonte G25
- crépine de non-retour en fonte G25
- arbre en acier inoxydable AISI 420
- couvre-câble en acier inoxydable AISI 304
- crépine d'aspiration en acier inoxydable AISI 304
- visserie en acier inoxydable AISI 304

CARACTÉRISTIQUES:

- débit maximum: 2167 l/m
- hauteur maximale: 649 mètres
- puissance maximale: 150 Kw
- diamètre d'encombrement maximum: 242 mm (inclus le couvre-câble)
- température maximale de l'eau: 60°C (pour la pompe, pour le moteur voir le catalogue des moteurs)
- quantité maximale de sable: 30 g/m³

OPTIONAL:

Sur demande on peut fournir pompes en fonte:

- avec roues en bronze GCuSn10 (B10)
- avec roues en acier inoxydable AISI 316



ELETTROPOMPE SOMMERSE 10" RADIALI IN BRONZO

10" BRONZE RADIAL-FLOW SUBMERSIBLE ELECTROPUMPS

ÉLECTROPOMPES IMMERGÉES 10" RADIALES EN BRONZE

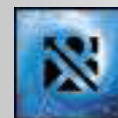

APPLICAZIONI:

- irrigazione, approvvigionamento idrico, aumento pressione ed antincendio
- acqua di mare
- acque salmastre

CONSTRUZIONE:

- girante in bronzo GCuSn10 (B10)
- corpo di stadio in bronzo GCuSn10 (B10)
- bocca di mandata in bronzo GCuSn10 (B10)
- valvola di ritegno in bronzo GCuSn10 (B10)
- albero in acciaio inox AISI 316
- copri cavo in acciaio inox AISI 316
- griglia d'aspirazione in acciaio inox AISI 316
- viteria in acciaio inox AISI 316

CARATTERISTICHE:

- portata massima: 2167 l/m
- prevalenza massima: 649 metri
- potenza massima: 150 Kw
- diametro d'ingombro massimo: 242 mm (incluso il copri cavo)
- temperatura massima dell'acqua: 60°C (solo per corpo pompa, per il motore vedi catalogo motori)
- contenuto di sabbia massimo: 30 g/m³



APPLICATIONS:

- irrigation, water supply system, pressure boosting and fire-fighting systems
- sea water
- brackish water

CONSTRUCTION:

- bronze GCuSn10 (B10) impellers
- bronze GCuSn10 (B10) delivery bowl
- bronze GCuSn10 (B10) pump body
- bronze GCuSn10 (B10) non-return valve
- stainless steel AISI 316 shaft
- stainless steel AISI 316 cable cover
- stainless steel AISI 316 suction strainer
- stainless steel AISI 316 nuts, bolts and screws

FEATURES:

- maximum capacity: 2167 l/m
- maximum head: 649 meters
- maximum power: 150 kw
- maximum encumbrance diameter: 242 mm (cable cover included)
- maximum water temperature: 60°C (only for the pump, for the motor see motors' catalogue)
- maximum sand content: 30 g/m³



APPLICATIONS:

- irrigation, installation d'approvisionnement hydrique, surpression et anti incendie
- eau de mer
- eau saumâtre

CONSTRUCTION:

- roues en bronze GCuSn10 (B10)
- corps d'étage en bronze GCuSn10 (B10)
- orifice de refoulement bronze GCuSn10 (B10)
- crépine de non-retour en bronze GCuSn10 (B10)
- arbre en acier inoxydable AISI 316
- couvre-câble en acier inoxydable AISI 316
- crépine d'aspiration en acier inoxydable AISI 316
- visserie en acier inoxydable AISI 316

CARACTÉRISTIQUES:

- débit maximum: 2167 l/m
- hauteur maximale: 649 mètres
- puissance maximale: 150 Kw
- diamètre d'encombrement maximum: 242 mm (inclus le couvre-câble)
- température maximale de l'eau: 60°C (pour la pompe, pour le moteur voir le catalogue des moteurs)
- quantité maximale de sable: 30 g/m³



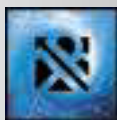

FB10R

SPACCATO 10"

10" CUTAWAY

COUPE 10"

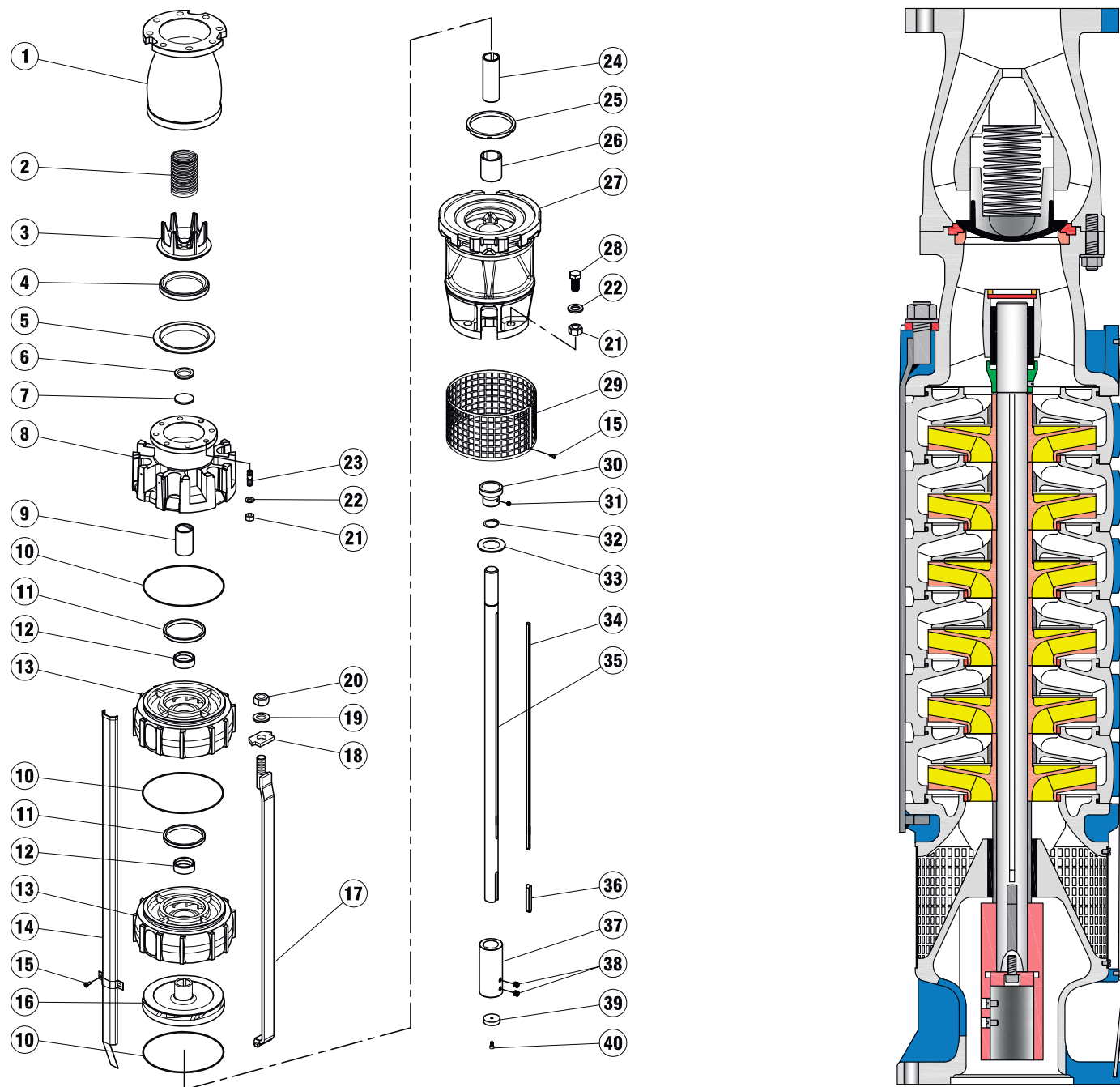

Pos.	Qt.	Denominazione	Denomination	Denomination
1	1	Corpo della valvola	Valve body	Corps de clapet
2	1	Molla della valvola	Valve spring	Ressort de soupape
3	1	Otturatore della valvola	Wing valve	Soupape du clapet
4	1	Sede valvola	Valve seat	Siège de soupape
5	1	Anello di raccordo	Valve insert ring	Bague du clapet
6	1	Anello di fermo	Circlip	Segment d'arrêt
7	1	Filtro di sfiato	Vent filter	Filtre de purge d'air
8	1	Camera premente	Discharge casing	Corps de refoulement
9	1	Cuscinetto a boccia	Bearing bush	Coussinet
10	*Nx8	Guarnizione corpo	Joint for stage casing	Joint du corps d'étage
11	*N	Anello di usura fisso	Casing wear ring	Bague d'usure
12	*N	Bussola distanziale	Interstage bush	Douille entre étages
13	*N	Corpo di stadio	Stage casing	Corps d'étage
14	1-2	Tegolo protezione cavo	Cable guard	Protège-cable
15	6-10	Vite	Screw	Vis
16	*N	Girante	Impeller	Roue
17	6	Tirante del corpo	Tie bolt	Tirant d'assemblage
18	6	Piastrina per tirante	Pressure plate	Rondelle spéciale
19	6	Rosetta	Washer	Rondelle
20	6	Dado	Nut	Ecrou

Pos.	Qt.	Denominazione	Denomination	Denomination
21	4-9	Dado	Nut	Ecrou
22	4-9	Rosetta	Washer	Rondelle
23	9	Prigioniero	Stud	Goujon
24	1	Bussola distanziale	Bearing sleeve	Chemise d'arbre
25	1	Anello di usura fisso	Casing wear ring	Bague d'usure
26	1	Cuscinetto a boccia	Bearing bush	Coussinet
27	1	Camera aspirante	Suction casing	Corps d'aspiration
28	4	Vite	Screw	Vis
29	1	Griglia d'aspirazione	Suction strainer	Crépine d'aspiration
30	1	Campana antisabbia	Sand guard	Cloche anti-sable
31	1	Vite	Screw	Vis
32	1	Anello di fermo	Circlip for shaft	Segment d'arrêt
33	1	Rondella di compens.	Compensating washer	Rondelle de compens.
34	1	Linguetta girante	Key for impeller	Clavette de la roue
35	1	Albero pompa	Pump shaft	Arbre de pompe
36	1	Linguetta giunto	Key for coupling	Clavette pour accoupl.
37	1	Giunto	Coupling	Accouplement
38	4	Vite per giunto	Screw for coupling	Vis pour accouplement
39	1	Disco del giunto	Thrust insert	Vis de butée accoupl.
40	1	Vite	Screw	Vis

*N=Numero di scatole e giranti variabili dal tipo di pompa

*N=The number of the boxer and the impellers vary according to the type of the pump.

*N=Numéro d'enveloppes et roues selon le type de pompe.

TABELLA DELLE CARATTERISTICHE IDRAULICHE 10"

10" HYDRAULIC FEATURES' CHART

TABLE DES CARACTÉRISTIQUES HYDRAULIQUES 10"

FB10R

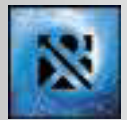

n=2900 1/min 50 Hz

Tipo Type Type	Motore Motor Moteur		Q = Portata - Capacity - Débit																			
			l/sec	0	7,0	8,3	11,1	13,9	16,7	19,5	22,2	23,6	25	27,8	30,6	33,3	36,1					
	l/min	0	417	500	667	833	1000	1167	1333	1417	1500	1667	1833	2000	2167							
	Hp	Kw	mc/h	0	25	30	40	50	60	70	80	85	90	100	110	120	130					
FB10RA/2A	20	15	H(m)	73	71	70	68	64	58	49	37	30										
FB10RA/3A	30	22		111	108	107	103	97	88	75	56	45										
FB10RA/4A	40	30		150	146	144	139	131	118	101	75	61										
FB10RA/5A	50	37		191	186	184	178	167	151	129	96	78										
FB10RA/6A	60	45		229	223	220	213	200	181	154	116	93										
FB10RA/7A	70	51		267	260	257	249	234	211	180	135	109										
FB10RA/8A	80	59		306	297	294	284	267	241	206	154	124										
FB10RA/9A	90	66		344	334	330	320	301	271	231	173	140										
FB10RA/10A	100	75		382	372	367	355	334	302	257	193	155										
FB10RA/11A	125	92		420	409	404	391	367	332	283	212	171										
FB10RA/12A	125	92		458	446	440	426	401	362	308	231	186										
FB10RA/13A	150	110		497	483	477	462	434	392	334	250	202										
FB10RA/14A	150	110		535	519	512	497	466	421	358	269	217										
FB10RA/15A	150	110		573	557	551	533	501	452	386	289	233										
FB10RA/16A	180	132		611	594	587	568	534	482	411	308	248										
FB10RA/17A	180	132		649	632	624	604	568	513	437	327	264										
FB10RB/2A	25	18,5		70				64	62	60	57	56	54	49	44	38	31					
FB10RB/3A	40	30	107				97	94	91	87	84	81	75	67	57	47						
FB10RB/4A	50	37	143				131	127	123	117	114	110	101	90	77	63						
FB10RB/5D	60	45	170				157	154	148	140	135	130	118	106	90	72						
FB10RB/5A	70	51	183				167	162	157	150	145	140	129	115	99	80						
FB10RB/6A	80	59	220				200	194	188	179	174	168	154	138	119	96						
FB10RB/7A	90	66	256				233	226	219	209	202	196	180	161	138	112						
FB10RB/8A	100	75	293				266	259	250	239	230	224	202	184	158	128						
FB10RB/9A	125	92	329				300	291	282	269	257	252	226	207	178	144						
FB10RB/10A	125	92	366				333	324	313	299	290	280	256	230	198	160						
FB10RB/11A	150	110	403				366	356	344	329	320	308	284	253	217	176						
FB10RB/12A	150	110	439				400	388	376	359	347	336	308	276	237	192						
FB10RB/13A	180	132	476				433	421	407	389	380	364	335	299	257	208						
FB10RB/14A	180	132	512				466	453	438	419	405	392	357	322	277	224						
FB10RB/15A	200	150	549				500	486	472	448	431	415	385	342	295	242						

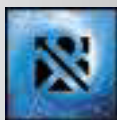

Tipo Type Type	Motore Motors 2900 g/m Moteurs		Q = Portata - Capacity - Débit									
			l/sec	0	7,0	8,3	11,1	13,9	16,7	19,5	22,2	23,6
			l/min	0	417	500	667	833	1000	1167	1333	1417
			m ³ /h	0	25	30	40	50	60	70	80	85
FB10RA/2A + 6F20	20	15	H(m)	73	71	70	68	64	58	49	37	30
FB10RA/3A + 8F30	30	22		111	108	107	103	97	88	75	56	45
FB10RA/4A + 8F40	40	30		150	146	144	139	131	118	101	75	61
FB10RA/5A + 8F50	50	37		191	186	184	178	167	151	129	96	78
FB10RA/6A + 8F60	60	45		229	223	220	213	200	181	154	116	93
FB10RA/7A + 8F70	70	51		267	260	257	249	234	211	180	135	109
FB10RA/8A + 8F80	80	59		306	297	294	284	267	241	206	154	124
FB10RA/9A + 8F90	90	66		344	334	330	320	301	271	231	173	140
FB10RA/10A + 10F100	100	75		382	372	367	355	334	302	257	193	155
FB10RA/11A + 10F125	125	92		420	409	404	391	367	332	283	212	171
FB10RA/12A + 10F125	125	92		458	446	440	426	401	362	308	231	186
FB10RA/13A + 10F150	150	110		497	483	477	462	434	392	334	250	202
FB10RA/14A + 10F150	150	110		535	519	512	497	466	421	358	269	217
FB10RA/15A + 10F150	150	110		573	557	551	533	501	452	386	289	233
FB10RA/16A + 10F180*	180	132		611	594	587	568	534	482	411	308	248
FB10RA/17A + 10F180*	180	132		649	632	624	604	568	513	437	327	264

Dimensioni e pesi

Overall dimensions and weights - Dimensions d'encombrement et poids

Tipo Type Type	Cv Hp	Kw	A (mm)	B (mm)	C (mm)	D (mm)	ø max (mm)	DN	Peso - Weight - Poids		
									A (kg)	B (kg)	C (kg)
									FB10RA/2A + 6F20	20	15
FB10RA/3A + 8F30	30	22	1879	900	979	240	226	94	132		
FB10RA/4A + 8F40	40	30	2019	970	1049		242	104	138		
FB10RA/5A + 8F50	50	37	2159	1040	1119		267	114	153		
FB10RA/6A + 8F60	60	45	2339	1110	1229		295	124	171		
FB10RA/7A + 8F70	70	51	2409	1180	1229		306	134	172		
FB10RA/8A + 8F80	80	59	2599	1250	1349		328	144	184		
FB10RA/9A + 8F90	90	66	2739	1320	1419		359	154	205		
FB10RA/10A + 10F100	100	75	2828	1390	1438		472	167	305		
FB10RA/11A + 10F125	125	92	3028	1460	1568		525	177	348		
FB10RA/12A + 10F125	125	92	3098	1530	1568		535	187	348		
FB10RA/13A + 10F150	150	110	3308	1600	1708		591	197	394		
FB10RA/14A + 10F150	150	110	3378	1670	1708		598	204	394		
FB10RA/15A + 10F150	150	110	3448	1740	1708		611	217	394		
FB10RA/16A + 10F180*	180	132	3618	1810	1808		648	227	421		
FB10RA/17A + 10F180*	180	132	3688	1880	1808		658	237	421		

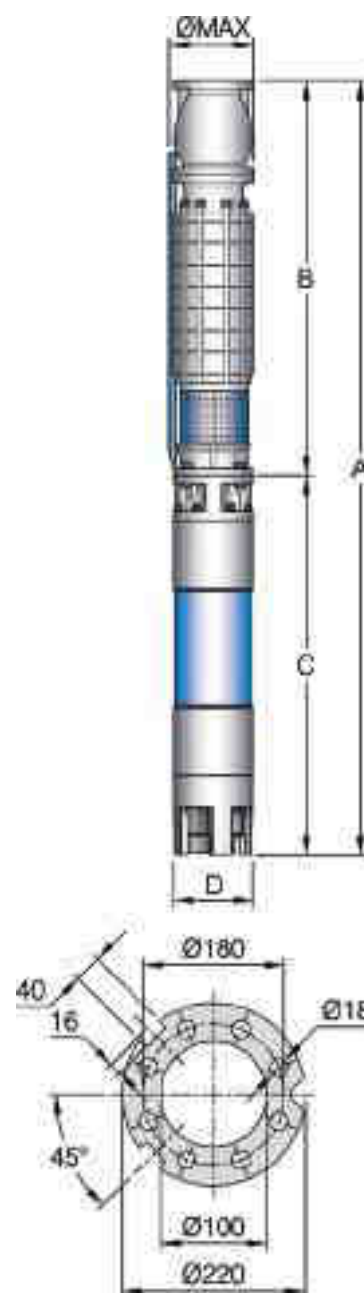

* Non consigliata per montaggio in posizione orizzontale

* This electropump isn't recommended for horizontal assemblage

* Cette électropompe n'est pas recommandée pour le montage en position horizontale

CURVE DELLE PRESTAZIONI

PERFORMANCES' CURVES

COURBES DES PERFORMANCES

FB10RA

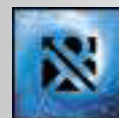

n=2900 1/min 50 Hz

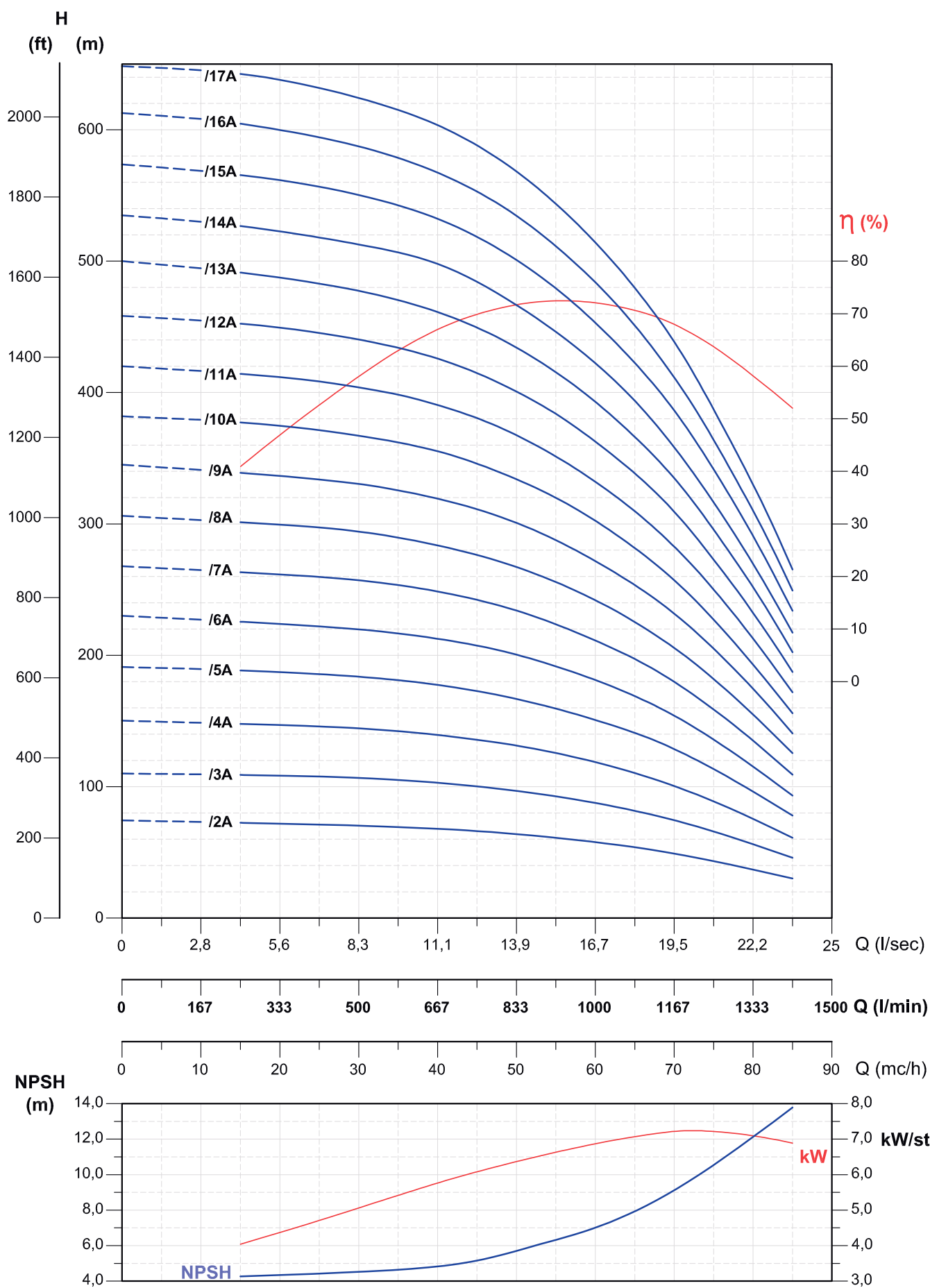

Tolleranze secondo EN ISO 9906 app.A Gr.2 - Tolerances according to EN ISO 9906 anx.A Gr.2 - Tolérances conformes EN ISO 9906 ann.A Gr.2

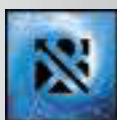

Tipo Type Type	Motore Motors 2900 g/m Moteurs		Q = Portata - Capacity - Débit									
	Cv Hp	Kw	l/sec	0	13,9	16,7	19,5	22,2	25	30,6	33,3	36,1
			l/min	0	833	1000	1167	1333	1500	1833	2000	2167
			mc/h	0	50	60	70	80	90	110	120	130
FB10RB/2A + 6F25	25	18,5	H(m)	70	64	62	60	57	54	44	38	31
FB10RB/3A + 8F40	40	30		107	97	94	91	87	81	67	57	47
FB10RB/4A + 8F50	50	37		143	131	127	123	117	110	90	77	63
FB10RB/5D + 8F60	60	45		170	157	154	148	140	130	106	90	72
FB10RB/5A + 8F70	70	51		183	167	162	157	150	140	115	99	80
FB10RB/6A + 8F80	80	59		220	200	194	188	179	168	138	119	96
FB10RB/7A + 8F90	90	66		256	233	226	219	209	196	161	138	112
FB10RB/8A + 10F100	100	75		293	266	259	250	239	224	184	158	128
FB10RB/9A + 10F125	125	92		329	300	291	282	269	252	207	178	144
FB10RB/10A + 10F125	125	92		366	333	324	313	299	280	230	198	160
FB10RB/11A + 10F150	150	110		403	366	356	344	329	308	253	217	176
FB10RB/12A + 10F150	150	110		439	400	388	376	359	336	276	237	192
FB10RB/13A + 10F180*	180	132		476	433	421	407	389	364	299	257	208
FB10RB/14A + 10F180*	180	132		512	466	453	438	419	392	322	277	224
FB10RB/15A + 10F200*	200	150		549	500	486	472	448	415	342	295	242

Dimensioni e pesi

Overall dimensions and weights - Dimensions d'encombrement et poids

Tipo Type Type	Cv Hp	Kw	A (mm)	B (mm)	C (mm)	D (mm)	ø max (mm)	DN	Peso - Weight - Poids		
									A (kg)	B (kg)	C (kg)
FB10RB/2A + 6F25	25	18,5	1699	802	897	145	242	100	156	81	75
FB10RB/3A + 8F40	40	30	1949	900	1049	192			232	94	138
FB10RB/4A + 8F50	50	37	2089	970	1119				257	104	153
FB10RB/5D + 8F60	60	45	2269	1040	1229				285	114	171
FB10RB/5A + 8F70	70	51	2269	1040	1229				286	114	172
FB10RB/6A + 8F80	80	59	2459	1110	1349				308	124	184
FB10RB/7A + 8F90	90	66	2599	1180	1419				339	134	205
FB10RB/8A + 10F100	100	75	2688	1250	1438				452	147	305
FB10RB/9A + 10F125	125	92	2888	1320	1568	502			154	348	
FB10RB/10A + 10F125	125	92	2958	1390	1568	515			167	348	
FB10RB/11A + 10F150	150	110	3168	1460	1708	571			177	394	
FB10RB/12A + 10F150	150	110	3238	1530	1708	581			187	394	
FB10RB/13A + 10F180*	180	132	3408	1600	1808	618			197	421	
FB10RB/14A + 10F180*	180	132	3478	1670	1808	628			207	421	
FB10RB/15A + 10F200*	200	150	3668	1740	1928	667			217	450	

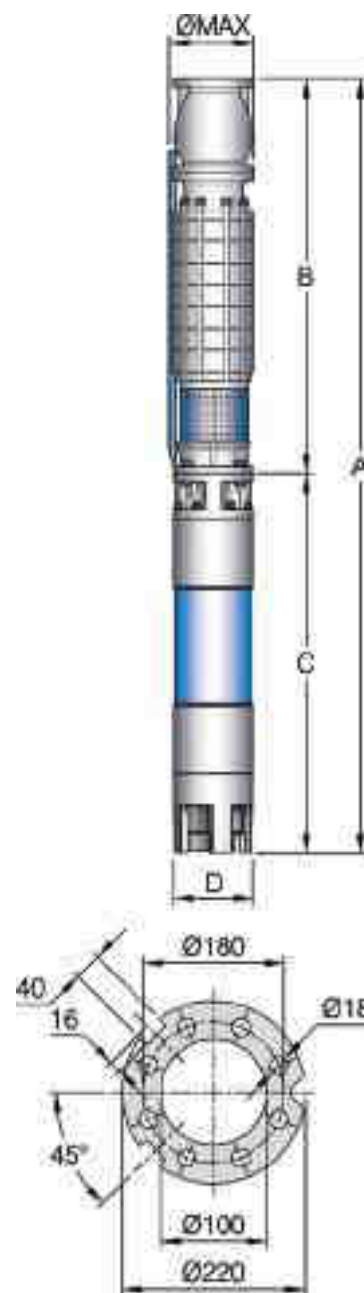

* Non consigliata per montaggio in posizione orizzontale

* This electropump isn't recommended for horizontal assemblage

* Cette électropompe n'est pas recommandée pour le montage en position horizontale

CURVE DELLE PRESTAZIONI

PERFORMANCES' CURVES

COURBES DES PERFORMANCES

FB10RB

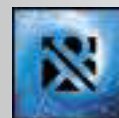

n=2900 1/min 50 Hz

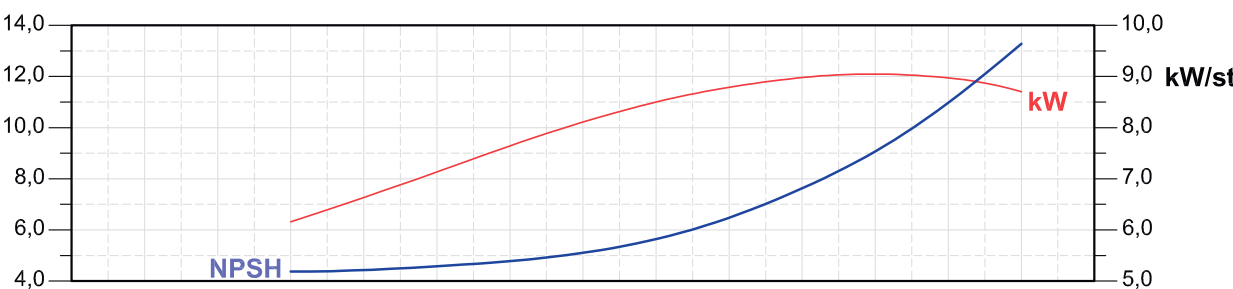
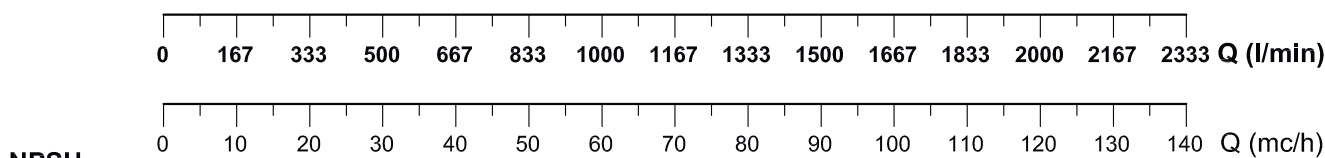
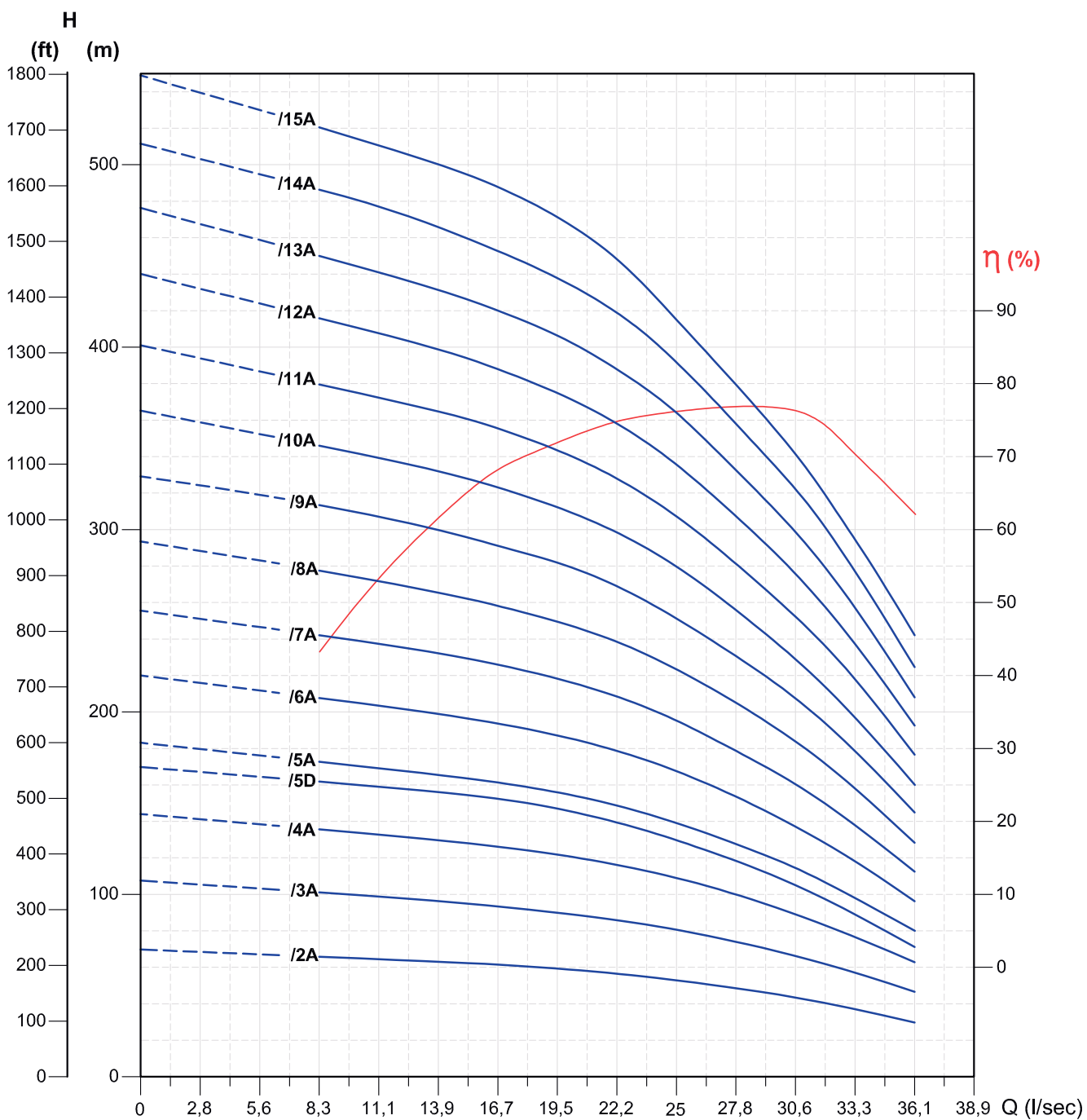

Tolleranze secondo EN ISO 9906 app.A Gr.2 - Tolerances according to EN ISO 9906 anx.A Gr.2 - Tolérances conformes EN ISO 9906 ann.A Gr.2

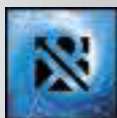

ELETTROPOMPE SOMMERSE 10" SEMIASSIALI IN GHISA

10" CAST IRON MIXED-FLOW SUBMERSIBLE ELECTROPUMPS
ÉLECTROPOMPES IMMERGÉES 10" SEMI-AXIALES EN FONTE



I corpi pompa 10" di tipo semiassiale in ghisa, serie FB10S, sono per acque pulite per pozzi 10" DN 250.

Questo tipo di pompa è costituito dalla presenza dei corpi di stadio con diffusore incorporato e delle giranti semiassiali, questa tipologia è da preferire quando si ha necessità di avere portate elevate con prevalenze medio - basse.

APPLICAZIONI:

- irrigazione
- approvvigionamento idrico
- aumento pressione
- antincendio

COSTRUZIONE:

- girante in ghisa G25
- corpo di stadio in ghisa G25
- bocca di mandata in ghisa G25
- valvola di ritegno in ghisa G25
- albero in acciaio inox AISI 420
- copri cavo in acciaio inox AISI 304
- griglia d'aspirazione in acciaio inox AISI 304
- viteria in acciaio inox AISI 304

CARATTERISTICHE:

- portata massima: 6000 l/m
- prevalenza massima: 378 metri
- potenza massima: 190 Kw
- diametro d'ingombro massimo: 248 mm (incluso il copri cavo)
- temperatura massima dell'acqua: 60°C (solo per corpo pompa, per il motore vedi catalogo motori)
- contenuto di sabbia massimo: 100 g/m³

OPTIONAL:

Su richiesta si possono fornire corpi pompa in ghisa:

- con giranti in bronzo GCuSn10 (B10)
- con giranti in acciaio inox AISI 316



10" pumps mixed-flow type, range FB10S, are for clean water for 10" wells DN 250.

This pumps have mixed-flow impellers with diffusers combined on each stage. They may be chosen when high capacity and medium-low head are needed.

APPLICATIONS:

- irrigation
- water supply system
- pressure boosting
- fire-fighting systems

CONSTRUCTION:

- cast iron G25 impellers
- cast iron G25 delivery bowl
- cast iron G25 pump body
- cast iron G25 non-return valve
- stainless steel AISI 420 shaft
- stainless steel AISI 304 cable cover
- stainless steel AISI 304 suction strainer
- stainless steel AISI 304 nuts, bolts and screws

FEATURES:

- maximum capacity: 6000 l/m
- maximum head: 378 meters

- maximum power: 190 Kw
- maximum encumbrance diameter: 248 mm (cable cover included)
- maximum water temperature: 60°C (only for the pump, for the motor see motors' catalogue)
- maximum sand content: 100 g/m³

OPTIONAL:

On demand cast iron pumps can be manufactured with:

- bronze GCuSn10 (B10) impellers
- stainless steel AISI 316 impellers



Les pompes 10" semi-axiales en fonte, série FB10S, sont pour eaux propres pour puits de 10" DN250.

Ces pompes sont caractérisées par la présence de stades avec le diffuseur incorporé et roues semi-axiales.

La gamme semi-axiale est à préférer quand il faut avoir hautes débits avec des moyens et grands hauteurs.

APPLICATIONS:

- irrigation
- installation d'approvisionnement hydrique
- surpression
- anti incendie

CONSTRUCTION:

- roues en fonte G25
- corps d'étage en fonte G25
- orifice de refoulement en fonte G25
- crépine de non-retour en fonte G25
- arbre en acier inoxydable AISI 420
- couvre-câble en acier inoxydable AISI 304
- crépine d'aspiration en acier inoxydable AISI 304
- visserie en acier inoxydable AISI 304

CARACTÉRISTIQUES:

- débit maximum: 6000 l/m
- hauteur maximale: 378 mètres
- puissance maximale: 190 Kw
- diamètre d'encombrement maximum: 248 mm (inclus le couvre-câble)
- température maximale de l'eau: 60°C (pour la pompe, pour le moteur voir le catalogue des moteurs)
- quantité maximale de sable: 100 g/m³

OPTIONAL:

Sur demande on peut fournir pompes en fonte:

- avec roues en bronze GCuSn10 (B10)
- avec roues en acier inoxydable AISI 316

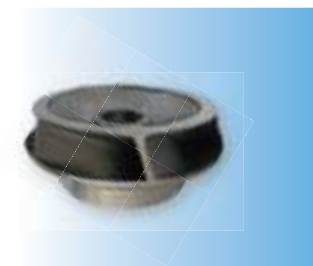

ELETTROPOMPE SOMMERSE 10" SEMIASSIALI IN BRONZO

10" BRONZE MIXED-FLOW SUBMERSIBLE ELECTROPUMPS

ÉLECTROPOMPES IMMERGÉES 10" SEMI-AXIALES EN BRONZE

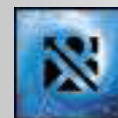

APPLICAZIONI:

- irrigazione, approvvigionamento idrico, aumento pressione ed antincendio
- acqua di mare
- acque salmastre

COSTRUZIONE:

- girante in bronzo GCuSn10 (B10)
- corpo di stadio in bronzo GCuSn10 (B10)
- bocca di mandata in bronzo GCuSn10 (B10)
- valvola di ritegno in bronzo GCuSn10 (B10)
- valvola di ritegno in bronzo GCuSn10 (B10)
- albero in acciaio inox AISI 316
- copri cavo in acciaio inox AISI 316
- griglia d'aspirazione in acciaio inox AISI 316
- viteria in acciaio inox AISI 316

CARATTERISTICHE:

- portata massima: 6000 l/m
- prevalenza massima: 378 metri
- potenza massima: 190 Kw
- diametro d'ingombro massimo: 248 mm (incluso il copri cavo)
- temperatura massima dell'acqua: 60°C (solo per corpo pompa, per il motore vedi catalogo motori)
- contenuto di sabbia massimo: 100 g/m³



APPLICATIONS:

- irrigation, water supply system, pressure boosting, fire-fighting systems
- sea water
- brackish water

CONSTRUCTION:

- bronze GCuSn10 (B10) impellers
- bronze GCuSn10 (B10) delivery bowl
- bronze GCuSn10 (B10) pump body
- bronze GCuSn10 (B10) non-return valve
- stainless steel AISI 316 shaft
- stainless steel AISI 316 cable cover
- stainless steel AISI 316 suction strainer
- stainless steel AISI 316 nuts, bolts and screws

FEATURES:

- maximum capacity: 6000 l/m
- maximum head: 378 meters
- maximum power: 190 Kw
- maximum encumbrance diameter: 248 mm (cable cover included)
- maximum water temperature: 60°C (only for the pump, for the motor see motors' catalogue)
- maximum sand content: 100 g/m³



APPLICATIONS:

- irrigation, installation d'approvisionnement hydrique, surpression et anti incendie
- eau de mer
- eau saumâtre

CONSTRUCTION:

- roues en bronze GCuSn10 (B10)
- corps d'étage en bronze GCuSn10 (B10)
- orifice de refoulement bronze GCuSn10 (B10)
- crépine de non-retour en bronze GCuSn10 (B10)
- arbre en acier inoxydable AISI 316
- couvre-câble en acier inoxydable AISI 316
- crépine d'aspiration en acier inoxydable AISI 316
- visserie en acier inoxydable AISI 316

CARACTÉRISTIQUES:

- débit maximum: 6000 l/m
- hauteur maximale: 378 mètres
- puissance maximale: 190 Kw
- diamètre d'encombrement maximum: 248 mm (inclus le couvre-câble)
- température maximale de l'eau: 60°C (pour la pompe, pour le moteur voir le catalogue des moteurs)
- quantité maximale de sable: 100 g/m³



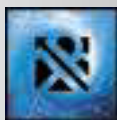

ELETTROPOMPE SOMMERSE 10" SEMIASSIALI IN ACCIAIO INOX AISI 316 E DUPLEX

10" STAINLESS STEEL AISI 316 AND DUPLEX MIXED-FLOW SUBMERSIBLE ELECTROPUMPS

ÉLECTROPOMPES IMMERGÉES 10" SEMI-AXIALES EN ACIER INOXYDABLE AISI 316 ET DUPLEX



APPLICAZIONI:

- irrigazione, approvvigionamento idrico, aumento pressione ed antincendio
- acqua potabile
- acque di mare
- acque salmastre
- acque termali e sulfuree
- desalinizzazione ed osmosi
- acque aggressive e corrosive
- vari settori dell'industria: alimentare, petrolchimica, siderurgica e navale
- applicazioni gravose: miniera

CONSTRUZIONE IN ACCIAIO INOX AISI 316:

PREN 26 (Pitting Resistance Equivalent)

- girante in acciaio inox AISI 316 (W. Nr. 1.4401)
- corpo di stadio in acciaio inox AISI 316 (W. Nr. 1.4401)
- bocca di mandata in acciaio inox AISI 316 (W. Nr. 1.4401)
- valvola di ritegno in acciaio inox AISI 316 (W. Nr. 1.4401)
- albero in acciaio inox AISI 316 (W. Nr. 1.4401)
- copri cavo in acciaio inox AISI 316 (W. Nr. 1.4401)
- griglia d'aspirazione in acciaio inox AISI 316 (W. Nr. 1.4401)
- viteria in acciaio inox AISI 316 (W. Nr. 1.4401)

CONSTRUZIONE IN ACCIAIO INOX DUPLEX:

PREN 31 (Pitting Resistance Equivalent)

- girante in acciaio inox duplex (W. Nr. 1.4462)
- corpo di stadio in acciaio inox duplex (W. Nr. 1.4462)
- bocca di mandata in acciaio inox duplex (W. Nr. 1.4462)
- valvola di ritegno in acciaio inox duplex (W. Nr. 1.4462)
- albero in acciaio inox duplex (W. Nr. 1.4462)
- copri cavo in acciaio inox (W. Nr. 1.4462)
- griglia d'aspirazione in acciaio inox (W. Nr. 1.4462)
- viteria in acciaio inox duplex (W. Nr. 1.4462)

CARATTERISTICHE:

- portata massima: 6000 l/m
- prevalenza massima: 378 metri
- potenza massima: 190 Kw
- diametro d'ingombro massimo: 248 mm (incluso il copri cavo)
- temperatura massima dell'acqua: 60°C (solo per corpo pompa, per il motore vedi catalogo motori)
- contenuto di sabbia massimo: 100 g/m³



APPLICATIONS:

- irrigation, water supply system, pressure boosting, fire-fighting systems
- sea water
- brackish water
- drinking water
- thermal and sulphurous water
- desalinization and osmosis
- aggressive and corrosive waters
- different sectors of the industry: such as food, petrochemical, steel and shipbuilding
- hard applications: mine

STAINLESS STEEL AISI 316 CONSTRUCTION:

PREN 26 (Pitting Resistance Equivalent)

- stainless steel AISI 316 (W. Nr. 1.4401) impellers
- stainless steel AISI 316 (W. Nr. 1.4401) delivery bowl
- stainless steel AISI 316 (W. Nr. 1.4401) pump body
- stainless steel AISI 316 (W. Nr. 1.4401) non-return valve
- stainless steel AISI 316 (W. Nr. 1.4401) shaft
- stainless steel AISI 316 (W. Nr. 1.4401) cable cover
- stainless steel AISI 316 (W. Nr. 1.4401) suction strainer
- stainless steel AISI 316 (W. Nr. 1.4401) nuts, bolts and screws

STAINLESS STEEL DUPLEX CONSTRUCTION:

PREN 31 (Pitting Resistance Equivalent)

- stainless steel duplex (W. Nr. 1.4462) impellers
- stainless steel duplex (W. Nr. 1.4462) delivery bowl
- stainless steel duplex (W. Nr. 1.4462) pump body
- stainless steel duplex (W. Nr. 1.4462) non-return valve
- stainless steel duplex (W. Nr. 1.4462) shaft
- stainless steel duplex (W. Nr. 1.4462) cable cover
- stainless steel duplex (W. Nr. 1.4462) suction strainer
- stainless steel duplex (W. Nr. 1.4462) nuts, bolts and screws

FEATURES:

- maximum capacity: 6000 l/m
- maximum head: 378 meters
- maximum power: 190 Kw
- maximum encumbrance diameter: 248 mm (cable cover included)
- maximum water temperature: 60°C (only for the pump, for the motor see motors' catalogue)
- maximum sand content: 100 g/m³



APPLICATIONS:

- irrigation, installation d'approvisionnement hydrique, surpression et anti incendie
- eau potable
- eau de mer
- eau saumâtre
- eau thermale e sulfureuse
- dessalement et osmose
- eau aggressive et corrosives
- différents secteurs de l'industrie: alimentaire, pétrochimie, sidérurgique et navale
- applications dures: mine

CONSTRUCTION EN ACIER INOXYDABLE AISI 316

PREN 26 (Pitting Resistance Equivalent)

- roues en acier inoxydable AISI 316 (W. Nr. 1.4401)
- corps d'étage en acier inoxydable AISI 316 (W. Nr. 1.4401)
- orifice de refoulement en acier inoxydable AISI 316 (W. Nr. 1.4401)
- crépine de non-retour en acier inoxydable AISI 316 (W. Nr. 1.4401)
- arbre en acier inoxydable AISI 316 (W. Nr. 1.4401)
- couvre-câble en acier inoxydable AISI 316 (W. Nr. 1.4401)
- crépine d'aspiration en acier inoxydable AISI 316 (W. Nr. 1.4401)
- visserie en acier inoxydable AISI 316 (W. Nr. 1.4401)

CONSTRUCTION EN ACIER INOXYDABLE DUPLEX

PREN 31 (Pitting Resistance Equivalent)

- roues en acier inoxydable duplex (W. Nr. 1.4462)
- corps d'étage en acier inoxydable duplex (W. Nr. 1.4462)
- orifice de refoulement en acier inoxydable duplex (W. Nr. 1.4462)
- crépine de non-retour en acier inoxydable duplex (W. Nr. 1.4462)
- arbre en acier inoxydable duplex (W. Nr. 1.4462)
- couvre-câble en acier inoxydable duplex (W. Nr. 1.4462)
- crépine d'aspiration en acier inoxydable duplex (W. Nr. 1.4462)
- visserie en acier inoxydable duplex (W. Nr. 1.4462)

CARACTÉRISTIQUES:

- débit maximum: 6000 l/m
- hauteur maximale: 378 mètres
- puissance maximale: 190 Kw
- diamètre d'encombrement maximum: 248 mm (inclus le couvre-câble)
- température maximale de l'eau: 60°C (pour la pompe, pour le moteur voir le catalogue des moteurs)
- quantité maximale de sable: 100 g/m³



SPACCATO 10"

10" CUTAWAY
COUPE 10"

FB10S

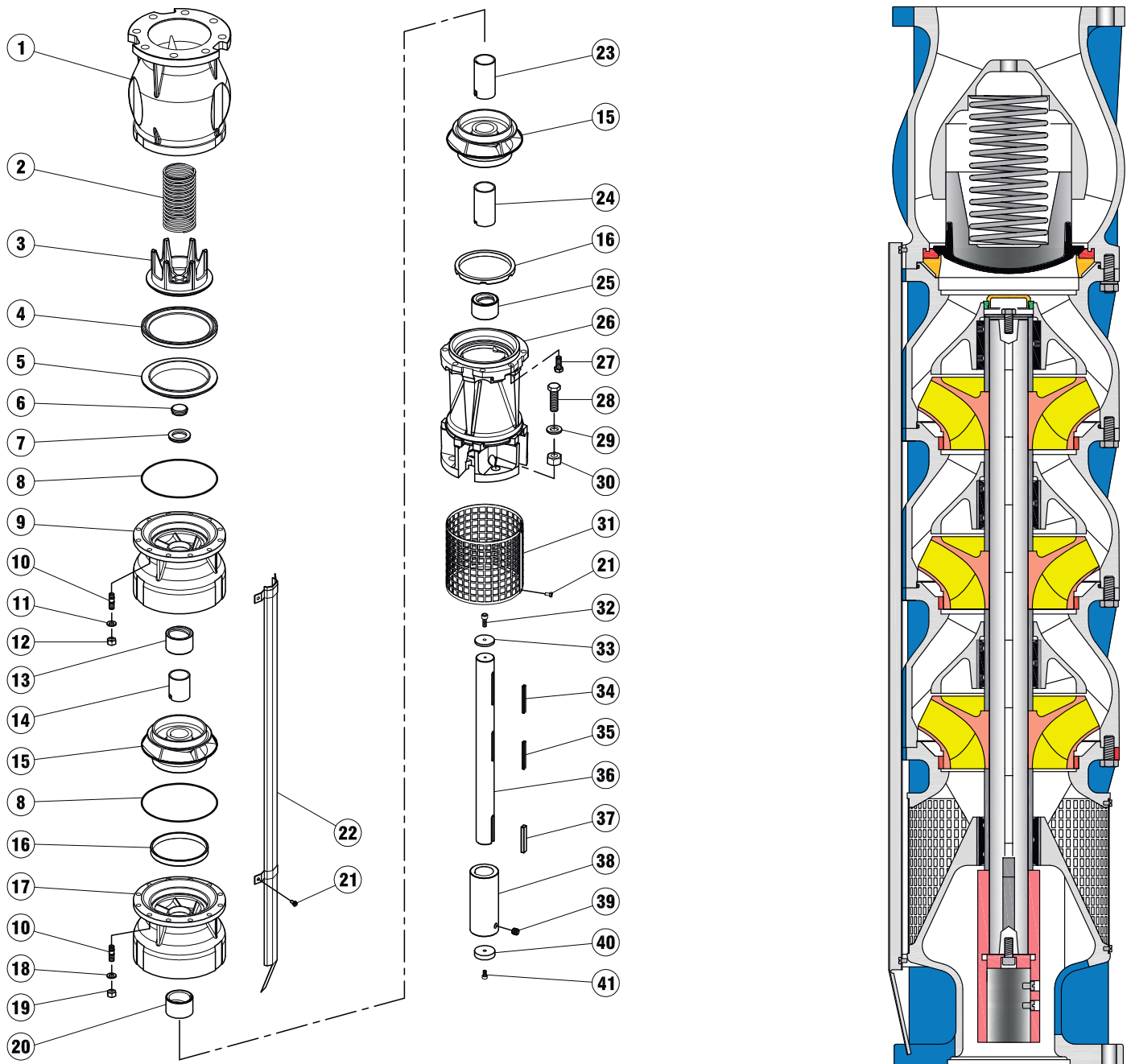
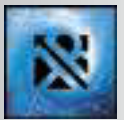

Pos.	Qt.	Denominazione	Denomination	Denomination
1	1	Corpo della valvola	Valve body	Corps de clapet
2	1	Molla della valvola	Valve spring	Ressort de soupape
3	1	Otturatore della valvola	Wing valve	Soupape du clapet
4	1	Sede valvola	Valve seat	Siège de soupape
5	1	Anello di raccordo	Valve insert ring	Bague du clapet
6	1	Corperchio di protez.	Vent plug	Bouchon de purge d'air
7	1	Anello di riduzione	Ring	Bague
8	*N-1	Guarnizione corpo	Joint for stage casing	Joint du corps d'étage
9	1	Corpo raddrizzatore	Pump bowl	Corps redresseur
10	*Nx12	Prigioniero	Stud	Goujon
11	12	Rosetta	Washer	Rondelle
12	12	Dado	Nut	Ecrou
13	1	Cuscinetto a boccola	Bearing bush	Coussinet
14	1	Bussola distanziale	Bearing sleeve	Chemise d'arbre
15	*N	Girante	Impeller	Roue
16	*N-1	Anello di usura fisso	Casing wear ring	Bague d'usure
17	*N-1	Corpo raddrizzatore	Pump bowl	Corps redresseur
18	*Nx12	Rosetta	Washer	Rondelle
19	*Nx12	Dado	Nut	Ecrou
20	*N-1	Bussola intermedia	Interstage bush	Douille entre étages
21	6-14	Vite	Screw	Vis

Pos.	Qt.	Denominazione	Denomination	Denomination
22	1-2	Tegolo protezione cavo	Cable guard	Protège-cable
23	*N-1	Bussola interstadi	Interstage sleeve	Chemise entretoise
24	1	Bussola distanziale	Bearing sleeve	Chemise d'arbre
25	1	Cuscinetto a boccola	Bearing bush	Coussinet
26	1	Camera aspirante	Suction casing	Corps d'aspiration
27	12	Vite	Screw	Vis
28	6	Vite	Screw	Vis
29	6	Rosetta	Washer	Rondelle
30	6	Dado	Nut	Ecrou
31	1	Griglia d'aspirazione	Suction strainer	Crépine d'aspiration
32	1	Vite	Screw	Vis
33	1	Rosetta ghiera albero	Washer for shaft nut	Rondelle pour arbre
34	*N-1	Linguetta girante	Key for impeller	Clavette de la roue
35	1	Linguetta girante	Key for impeller	Clavette de la roue
36	1	Albero pompa	Pump shaft	Arbre de pompe
37	1	Linguetta giunto	Key for coupling	Clavette pour accoupl.
38	1	Giunto	Coupling	Accouplement
39	2	Vite del giunto	Coupling screw	Plaque de blocage
40	1	Disco del giunto	Thrust insert	Vis de butée accoupl.
41	1	Vite	Screw	Vis

*N=Numero di scatole e giranti variabili dal tipo di pompa

*N=The number of the boxer and the impellers vary according to the type of the pump.

*N=Numéro d'enveloppes et roues selon le type de pompe.



TABELLA DELLE CARATTERISTICHE IDRAULICHE 10"

10" HYDRAULIC FEATURES' CHART

TABLE DES CARACTÉRISTIQUES HYDRAULIQUES 10"

Tipo Type Type	Motore Motor Moteur		Q = Portata - Capacity - Débit																					
			l/sec	0	22,2	25	27,8	30,6	33,3	36,1	38,9	41,7	44,5	47,2	50	52,8	55,6	61,1	66,7					
	l/min	0	1333	1500	1667	1833	2000	2167	2333	2500	2667	2833	3000	3167	3333	3667	4000							
Hp	Kw	mc/h	0	80	90	100	110	120	130	140	150	160	170	180	190	200	220	240						
FB10SE/1L	12,5	9,2		32	25	24	23	21	20	18	17	15	13	11										
FB10SE/1F	15	11		35	28	27	26	25	24	23	21	19	17	16	14									
FB10SE/1D	17,5	13		37	30	29	28	27	25	24	23	21	19	17	15	13								
FB10SE/1A	20	15		38	32	31	30	29	28	26	25	24	22	21	19	17								
FB10SE/2L	25	18,5		64	50	48	46	43	40	37	34	30	26	23										
FB10SE/2G	30	22		68	53	51	49	47	44	42	39	35	31	27										
FB10SE/2D	35	26		74	59	58	56	54	52	49	46	43	39	35	31	27								
FB10SE/3L	40	30		98	76	73	70	66	62	57	53	47	41	34										
FB10SE/3F	50	37		108	87	84	81	77	74	70	65	60	54	48	42									
FB10SE/4G	60	45		138	108	104	100	96	91	86	79	72	64	56										
FB10SE/4D	70	51	H(m)	152	121	118	114	110	106	100	94	87	80	72	63	55								
FB10SE/4A	75	55		156	129	126	123	118	114	109	104	98	92	85	77	69								
FB10SE/5F	80	59		180	145	140	135	129	123	116	108	100	90	80	70									
FB10SE/5D	85	62		190	152	148	143	138	132	125	118	109	100	90	79	69								
FB10SE/6F	90	66		216	173	167	162	154	148	139	130	120	108	96	84									
FB10SE/6D	100	75		228	182	177	171	165	158	150	142	131	120	108	95	83								
FB10SE/6A	125	92		234	193	189	184	177	171	164	156	147	137	128	116	103								
FB10SE/7A	150	110		273	225	221	215	207	200	191	182	172	160	149	135	120								
FB10SE/8A	180	132		312	258	252	245	236	228	218	208	196	183	170	154	137								
FB10SE/10A	200	150		378	315	305	295	287	275	263	252	237	222	202	188	169								
FB10SG/1N	15	11		31			22	21	21	20	19	19	17	16	15	14	12	8	5					
FB10SG/1G	17,5	13		36			26	25	25	24	23	22	21	20	20	18	17	14	11					
FB10SG/1F	20	15		39			29	28	27	26	25	24	24	23	22	21	19	17	16					
FB10SG/1A	25	18,5		42			33	32	31	30	29	29	28	27	26	25	24	21	18					
FB10SG/2L	30	22		68			49	47	46	44	42	41	39	37	34	32	29	23	15					
FB10SG/2G	35	26		73			53	51	50	48	47	45	43	41	39	37	35	29	21					
FB10SG/2F	40	30		78			58	56	54	53	51	49	48	46	44	42	39	34	28					
FB10SG/2A	50	37		84			68	65	63	61	60	58	56	55	53	51	48	43	36					
FB10SG/3F	60	45		119			89	86	83	81	78	76	73	71	68	65	60	52	42					
FB10SG/3D	70	51	H(m)	124			104	92	90	88	85	82	80	76	73	70	68	60	50					
FB10SG/3A	75	55		129			102	99	97	94	91	89	86	83	81	76	74	66	56					
FB10SG/4F	80	59		159			118	114	111	108	104	101	98	94	90	86	80	70	56					
FB10SG/4D	85	62		165			127	124	120	116	112	110	106	103	99	95	90	79	65					
FB10SG/5F	100	75		199			148	143	139	135	131	126	122	118	113	108	101	87	71					
FB10SG/6F	125	92		239			179	172	167	161	157	151	146	141	135	129	121	104	85					
FB10SG/6A	150	110		258			205	199	193	188	182	177	172	167	161	155	148	131	112					
FB10SG/7A	180	132		301			239	232	225	219	213	207	201	195	188	181	173	153	130					
FB10SG/8A	200	150		344			273	265	257	250	244	236	230	223	215	207	198	175	148					

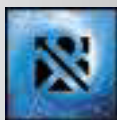
TABELLA DELLE CARATTERISTICHE IDRAULICHE 10”

10” HYDRAULIC FEATURES' CHART

TABLE DES CARACTÉRISTIQUES HYDRAULIQUES 10”



n=2900 1/min 50 Hz

Tipo Type Type	Motore Motor Moteur		Q = Portata - Capacity - Débit																			
			l/sec	0	27,8	33,3	38,9	44,5	50	55,6	61,1	66,7	72,2	77,8	83,3	88,9	94,5	100				
				l/min	0	1667	2000	2333	2667	3000	3333	3667	4000	4333	4667	5000	5333	5667	6000			
			mc/h		0	100	120	140	160	180	200	220	240	260	280	300	320	340	360			
Hp	Kw	H(m)																				
FB10SH/1L	20	15	34	27	26	25	24	23	21	19	16	13										
FB10SH/1F	25	18,5	38	32	30	29	28	27	25	23	21	18										
FB10SH/1D	30	22	39	33	32	31	29	28	27	25	24	21										
FB10SH/2N	35	26	63	50	48	45	44	41	37	33	26	20										
FB10SH/2L	40	30	68	55	52	50	48	46	43	39	33	26										
FB10SH/2F	50	37	76	64	61	59	56	54	51	47	43	37										
FB10SH/2D	60	45	79	67	65	63	59	57	55	51	48	42										
FB10SH/2A	70	51	84	72	70	67	64	62	59	56	53	48										
FB10SH/3F	75	55	117	98	94	90	86	82	78	72	65	56										
FB10SH/4L	85	62	139	112	106	102	98	94	88	80	67	53										
FB10SH/4G	90	66	152	123	118	112	108	102	96	88	78	66										
FB10SH/4F	100	75	156	130	125	120	115	110	103	96	87	75										
FB10SH/5F	125	92	195	163	156	150	144	137	129	120	109	94										
FB10SH/5D	150	110	201	170	165	158	151	145	139	132	122	109										
FB10SH/6D	180	132	241	203	198	189	181	174	168	158	146	131										
FB10SH/7F	180	132	273	228	218	210	201	192	181	168	152	131										
FB10SH/7D	200	150	281	238	231	221	211	203	195	184	170	152										
FB10SH/7A	230	170	300	258	249	239	229	221	211	201	189	172										
FB10SL/1G	35	26	35					27	26	26	24	23	21	19	17	15	12					
FB10SL/1A	40	30	41					33	32	31	30	29	27	26	23	21	18					
FB10SL/2N	50	37	63					48	46	45	42	39	35	30	25							
FB10SL/2G	60	45	72					55	54	52	49	47	43	39	35	29	23					
FB10SL/2F	70	51	75					60	59	58	54	51	47	43	38	33	26					
FB10SL/2D	75	55	77					63	61	59	57	54	51	47	43	37	31					
FB10SL/2A	80	59	82					67	65	63	61	58	55	52	47	42	36					
FB10SL/3L	85	62	106					79	77	74	71	66	60	53	45	36						
FB10SL/3G	90	66	110					84	82	80	76	72	66	60	54	44	35					
FB10SL/3F	100	75	116					92	89	86	82	78	72	66	59	51	41					
FB10SL/4G	125	92	146					113	109	106	101	96	88	80	71	60	48					
FB10SL/4D	150	110	157					129	125	121	116	112	104	96	88	77	64					
FB10SL/5G	180	132	183					142	138	133	127	120	110	100	89	75	60					
FB10SL/6G	180	132	219					170	164	159	151	143	132	120	106	90	72					
FB10SL/7L	200	150	248					183	179	172	165	154	140	124	105	84						
FB10SL/7F	230	170	270					214	207	201	192	182	169	154	137	119	95					
FB10SL/7D	260	190	275					225	218	211	204	195	182	168	154	134	112					

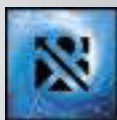

Tipo Type Type	Motore Motors 2900 g/m Moteurs		Q = Portata - Capacity - Débit									
	Cv Hp	Kw	l/sec	0	27,8	33,3	38,9	41,7	44,5	47,2	50	52,8
			l/min	0	1667	2000	2333	2500	2667	2833	3000	3167
			mc/h	0	100	120	140	150	160	170	180	190
FB10SE/1L + 6F12	12,5	9,2	H(m)	32	23	20	17	15	13	11		
FB10SE/1F + 6F15	15	11		35	26	24	21	19	17	16	14	
FB10SE/1D + 6F17	17,5	13		37	28	25	23	21	19	17	15	13
FB10SE/1A + 6F20	20	15		38	30	28	25	24	22	21	19	17
FB10SE/2L + 6F25	25	18,5		64	46	40	34	30	26	23		
FB10SE/2G + 6F30	30	22		68	49	44	39	35	31	27		
FB10SE/2D + 6F35	35	26		74	56	52	46	43	39	35	31	27
FB10SE/3L + 8F40	40	30		98	70	62	53	47	41	34		
FB10SE/3F + 8F50	50	37		108	81	74	65	60	54	48	42	
FB10SE/4G + 8F60	60	45		138	100	91	79	72	64	56		
FB10SE/4D + 8F70	70	51		152	114	106	94	87	80	72	63	55
FB10SE/4A + 8F75	75	55		156	123	114	104	98	92	85	77	69
FB10SE/5F + 8F80	80	59		180	135	123	108	100	90	80	70	
FB10SE/5D + 8F85	85	62		190	143	132	118	109	100	90	79	69
FB10SE/6F + 8F90	90	66		216	162	148	130	120	108	96	84	
FB10SE/6D + 10F100	100	75		228	171	158	142	131	120	108	95	83
FB10SE/6A + 10F125	125	92		234	184	171	156	147	137	128	116	103
FB10SE/7A + 10F150	150	110		273	215	200	182	172	160	149	135	120
FB10SE/8A + 10F180*	180	132		312	245	228	208	196	183	170	154	137
FB10SE/10A + 10F200*	200	150		378	295	275	252	237	222	202	188	169

Dimensioni e pesi

Overall dimensions and weights - Dimensions d'encombrement et poids

Tipo Type Type	Cv Hp	Kw	A (mm)	B (mm)	C (mm)	D (mm)	ø max (mm)	DN	Peso - Weight - Poids		
									A (kg)	B (kg)	C (kg)
FB10SE/1L + 6F12	12,5	9,2	1435	738	697	145	240	150	124	70	54
FB10SE/1F + 6F15	15	11	1505	738	767				131	70	61
FB10SE/1D + 6F17	17,5	13	1505	738	767				132	70	62
FB10SE/1A + 6F20	20	15	1565	738	827				138	70	68
FB10SE/2L + 6F25	25	18,5	1800	903	897				166	91	75
FB10SE/2G + 6F30	30	22	1870	903	967				173	91	82
FB10SE/2D + 6F35	35	26	1930	903	1027				180	91	89
FB10SE/3L + 8F40	40	30	2145	1096	1049				252	114	138
FB10SE/3F + 8F50	50	37	2215	1096	1119				267	114	153
FB10SE/4G + 8F60	60	45	2490	1261	1229				306	135	171
FB10SE/4D + 8F70	70	51	2490	1261	1229	307	135	172			
FB10SE/4A + 8F75	75	55	2610	1261	1349	319	135	184			
FB10SE/5F + 8F80	80	59	2775	1426	1349	340	156	184			
FB10SE/5D + 8F85	85	62	2775	1426	1349	340	156	184			
FB10SE/6F + 8F90	90	66	3010	1591	1419	382	177	205			
FB10SE/6D + 10F100	100	75	3029	1591	1438	484	179	305			
FB10SE/6A + 10F125	125	92	3159	1591	1568	527	179	348			
FB10SE/7A + 10F150	150	110	3464	1756	1708	594	200	394			
FB10SE/8A + 10F180*	180	132	3729	1921	1808	641	220	421			
FB10SE/10A + 10F200*	200	150	4179	2251	1928	691	241	450			

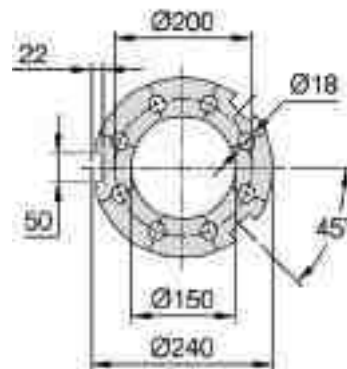
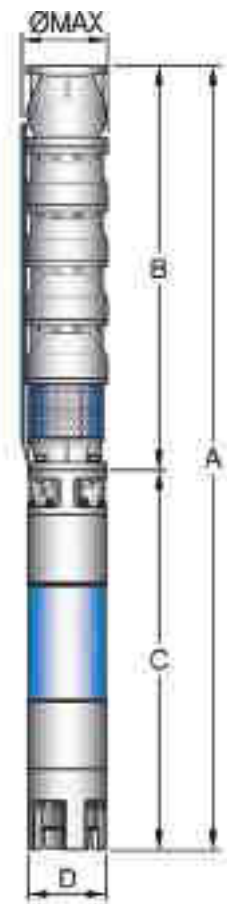

* Non consigliata per montaggio in posizione orizzontale

* This electropump isn't recommended for horizontal assemblage

* Cette électropompe n'est pas recommandée pour le montage en position horizontale

CURVE DELLE PRESTAZIONI

PERFORMANCES' CURVES

COURBES DES PERFORMANCES

FB10SE

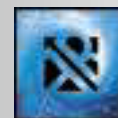

n=2900 1/min 50 Hz

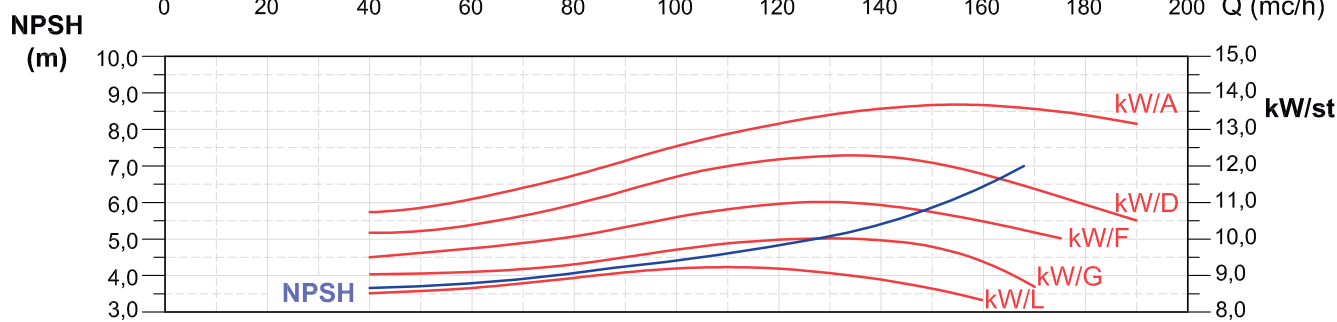
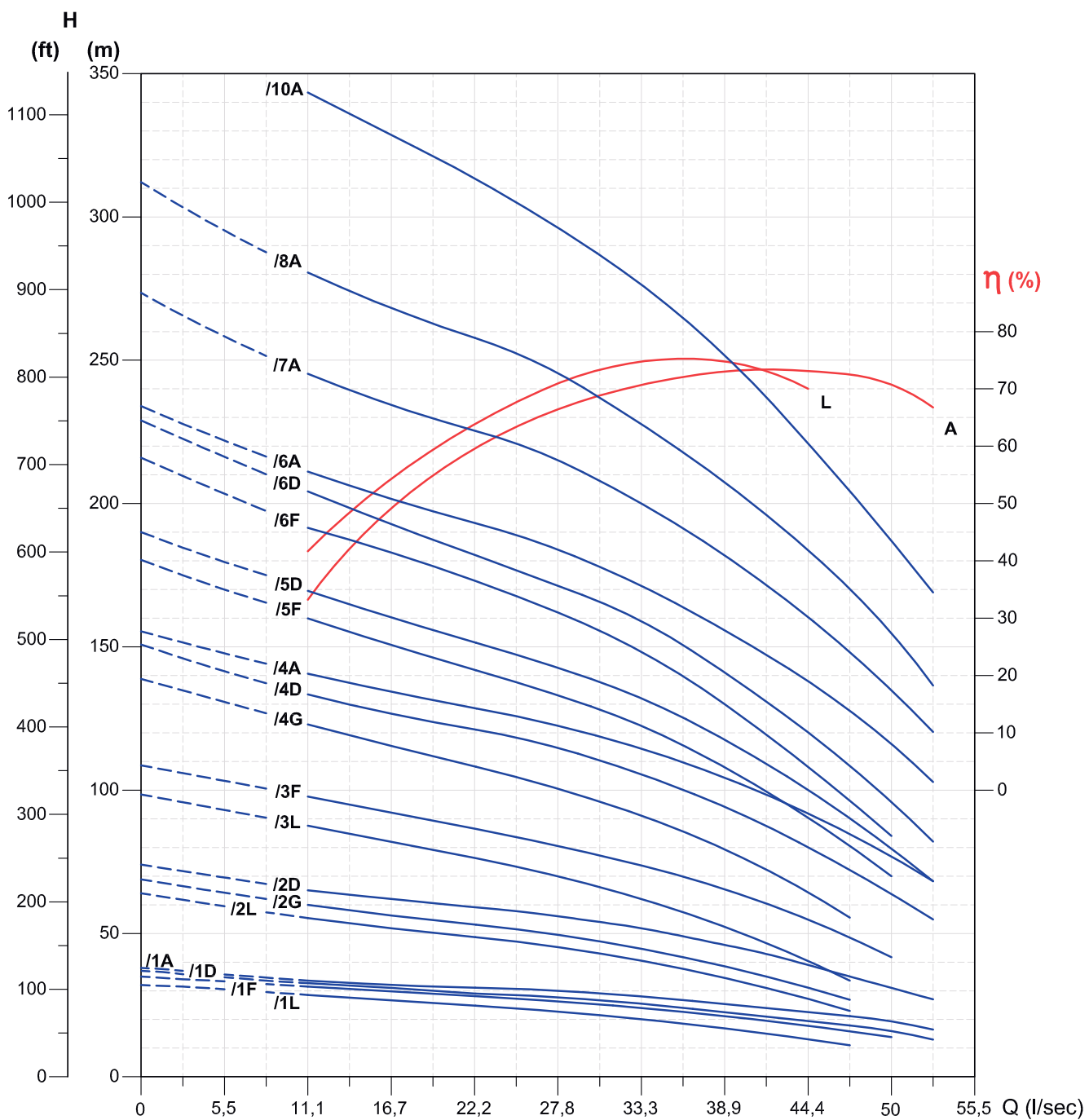

Tolleranze secondo EN ISO 9906 app.A Gr.2 - Tolerances according to EN ISO 9906 anx.A Gr.2 - Tolérances conformes EN ISO 9906 ann.A Gr.2

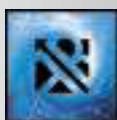

Tipo Type Type	Motore Motors Moteurs		Q = Portata - Capacity - Débit									
	Cv Hp	Kw	l/sec	0	27,8	33,3	38,9	44,5	50	55,6	61,1	66,7
			l/min	0	1667	2000	2333	2667	3000	3333	3667	4000
			mc/h	0	100	120	140	160	180	200	220	240
FB10SG/1N + 6F15	15	11	H(m)	31	22	21	19	17	15	12	8	5
FB10SG/1G + 6F17	17,5	13		36	26	25	23	21	20	17	14	11
FB10SG/1F + 6F20	20	15		39	29	27	25	24	22	19	17	16
FB10SG/1A + 6F25	25	18,5		42	33	31	29	28	26	24	21	18
FB10SG/2L + 6F30	30	22		68	49	46	42	39	34	29	23	15
FB10SG/2G + 6F35	35	26		73	53	50	47	43	39	35	29	21
FB10SG/2F + 8F40	40	30		78	58	54	51	48	44	39	34	28
FB10SG/2A + 8F50	50	37		84	68	63	60	56	53	48	43	36
FB10SG/3F + 8F60	60	45		119	89	83	78	73	68	60	52	42
FB10SG/3D + 8F70	70	51		124	104	90	85	80	73	68	60	50
FB10SG/3A + 8F75	75	55		129	102	97	91	86	81	74	66	56
FB10SG/4F + 8F80	80	59		159	118	111	104	98	90	80	70	56
FB10SG/4D + 8F85	85	62		165	127	120	112	106	99	90	79	65
FB10SG/5F + 10F100	100	75		199	148	139	131	122	113	101	87	71
FB10SG/6F + 10F125	125	92		239	179	167	157	146	135	121	104	85
FB10SG/6A + 10F150	150	110		258	205	193	182	172	161	148	131	112
FB10SG/7A + 10F180*	180	132	301	239	225	213	201	188	173	153	130	
FB10SG/8A + 10F200*	200	150	344	273	257	244	230	215	198	175	148	

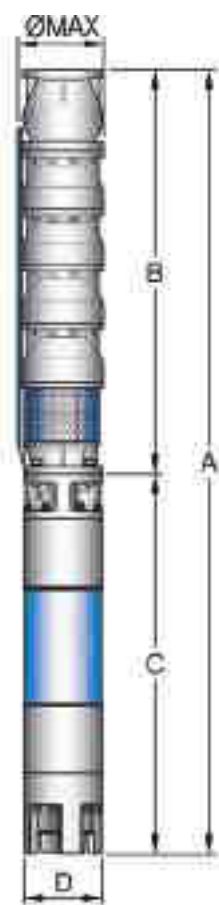

Dimensioni e pesi

Overall dimensions and weights - Dimensions d'encombrement et poids

Tipo Type Type	Cv Hp	Kw	A (mm)	B (mm)	C (mm)	D (mm)	ø max (mm)	DN	Peso - Weight - Poids		
									A (kg)	B (kg)	C (kg)
									FB10SG/1N + 6F15	15	11
FB10SG/1G + 6F17	17,5	13	1505	738	767	132	70	62			
FB10SG/1F + 6F20	20	15	1565	738	827	138	70	68			
FB10SG/1A + 6F25	25	18,5	1635	738	897	145	70	75			
FB10SG/2L + 6F30	30	22	1868	901	967	173	91	82			
FB10SG/2G + 6F35	35	26	1928	901	1027	180	91	89			
FB10SG/2F + 8F40	40	30	1980	931	1049	231	93	138			
FB10SG/2A + 8F50	50	37	2050	931	1119	246	93	153			
FB10SG/3F + 8F60	60	45	2325	1096	1229	285	114	171			
FB10SG/3D + 8F70	70	51	2325	1096	1229	286	114	172			
FB10SG/3A + 8F75	75	55	2445	1096	1349	298	114	184			
FB10SG/4F + 8F80	80	59	2610	1261	1349	319	135	184			
FB10SG/4D + 8F85	85	62	2610	1261	1349	319	135	184			
FB10SG/5F + 10F100	100	75	2864	1426	1438	463	158	305			
FB10SG/6F + 10F125	125	92	3159	1591	1568	527	179	348			
FB10SG/6A + 10F150	150	110	3299	1591	1708	573	179	394			
FB10SG/7A + 10F180*	180	132	3564	1756	1808	621	200	421			
FB10SG/8A + 10F200*	200	150	3829	1921	1908	671	221	450			

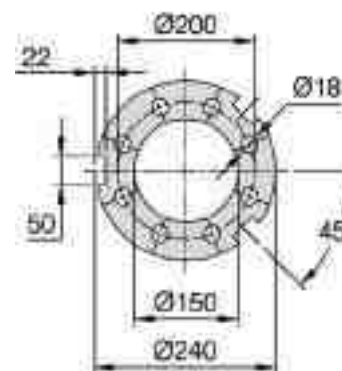

* Non consigliata per montaggio in posizione orizzontale

* This electropump isn't recommended for horizontal assemblage

* Cette électropompe n'est pas recommandée pour le montage en position horizontale

CURVE DELLE PRESTAZIONI

PERFORMANCES' CURVES

COURBES DES PERFORMANCES

FB10SG

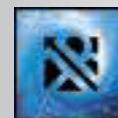

n=2900 1/min 50 Hz

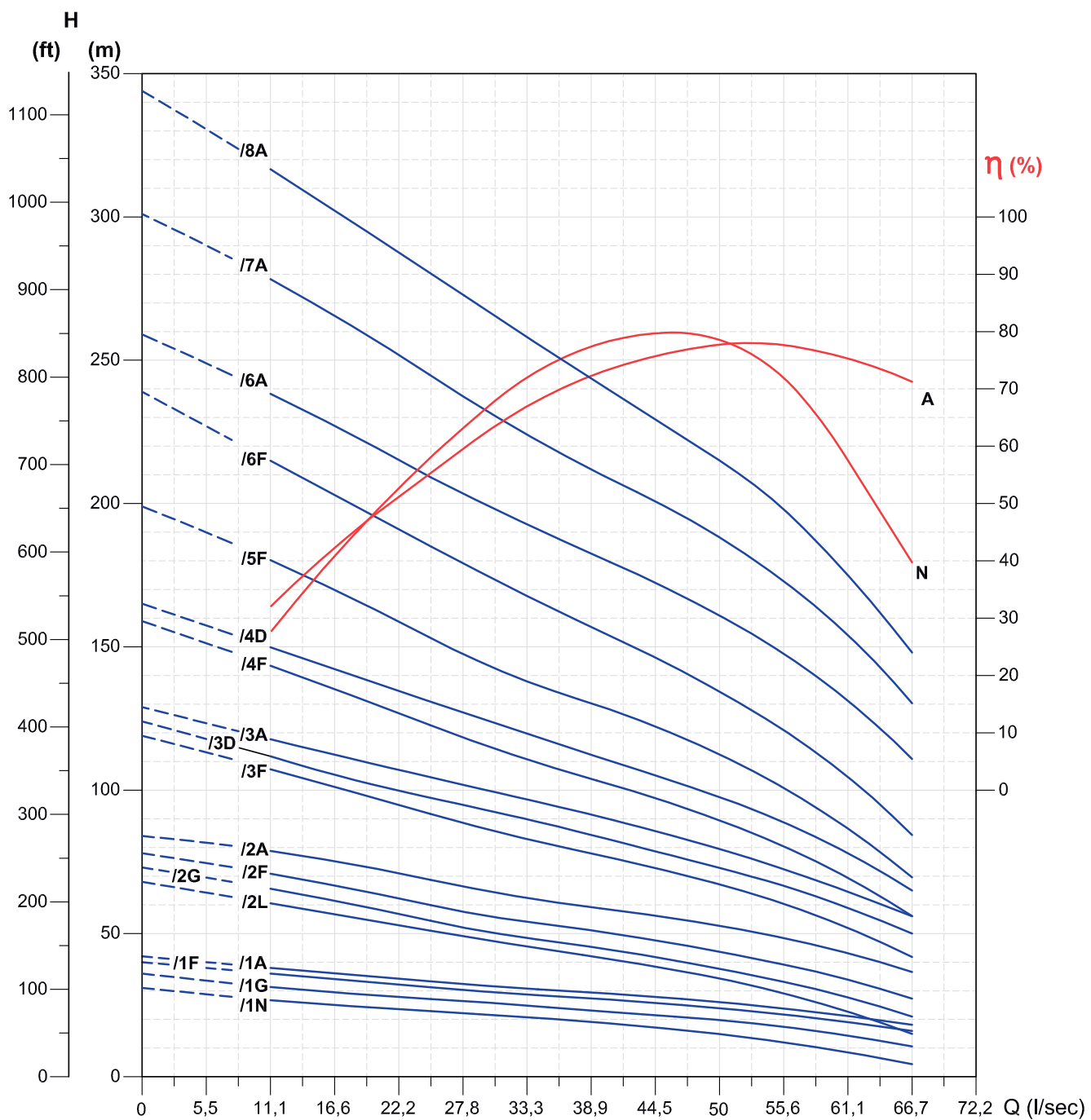

NPSH
(m)

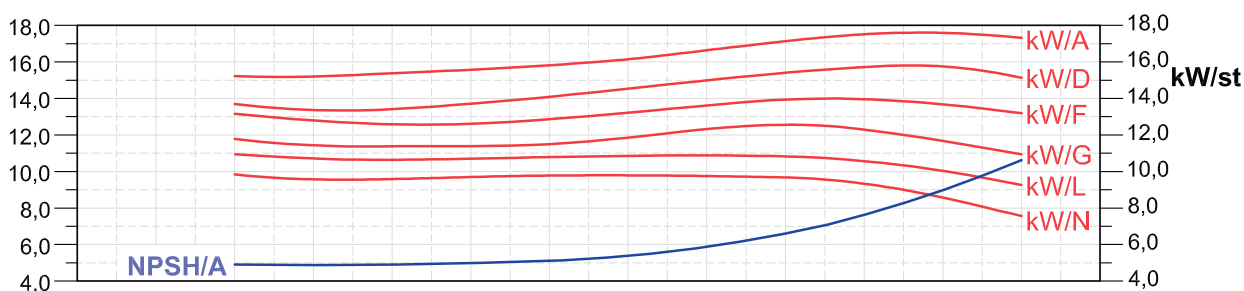

Tolleranze secondo EN ISO 9906 app.A Gr.2 - Tolerances according to EN ISO 9906 anx.A Gr.2 - Tolérances conformes EN ISO 9906 ann.A Gr.2

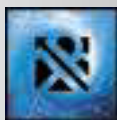

Tipo Type Type	Motore Motors 2900 g/m Moteurs		Q = Portata - Capacity - Débit											
			Cv Hp	Kw	l/sec	0	33,3	38,9	44,5	50	55,6	61,1	66,7	72,2
					l/min	0	2000	2333	2667	3000	3333	3667	4000	4333
					mc/h	0	120	140	160	180	200	220	240	260
FB10SH/1L + 6F20	20	15	34	26	25	24	23	21	19	16	13			
FB10SH/1F + 6F25	25	18,5	38	30	29	28	27	25	23	21	18			
FB10SH/1D + 6F30	30	22	39	32	31	29	28	27	25	24	21			
FB10SH/2N + 6F35	35	26	63	48	45	44	41	37	33	26	20			
FB10SH/2L + 8F40	40	30	68	52	50	48	46	43	39	33	26			
FB10SH/2F + 8F50	50	37	76	61	59	56	54	51	47	43	37			
FB10SH/2D + 8F60	60	45	79	65	63	59	57	55	51	48	42			
FB10SH/2A + 8F70	70	51	84	70	67	64	62	59	56	53	48			
FB10SH/3F + 8F75	75	55	117	94	90	86	82	78	72	65	56			
FB10SH/4L + 8F85	85	62	139	106	102	98	94	88	80	67	53			
FB10SH/4G + 8F90	90	66	152	118	112	108	102	96	88	78	66			
FB10SH/4F + 10F100	100	75	156	125	120	115	110	103	96	87	75			
FB10SH/5F + 10F125	125	92	195	156	150	144	137	129	120	109	94			
FB10SH/5D + 10F150	150	110	201	165	158	151	145	139	132	122	109			
FB10SH/6D + 10F180*	180	132	241	198	189	181	174	168	158	146	131			
FB10SH/7F + 10F180*	180	132	273	218	210	201	192	181	168	152	131			
FB10SH/7D + 10F200*	200	150	281	231	221	211	203	195	184	170	152			
FB10SH/7A + 10F230*	230	170	300	249	239	229	221	211	201	189	172			



Dimensioni e pesi

Overall dimensions and weights - Dimensions d'encombrement et poids

Tipo Type Type	Cv Hp	Kw	A (mm)	B (mm)	C (mm)	D (mm)	ø max (mm)	DN	Peso - Weight - Poids		
									A (kg)	B (kg)	C (kg)
									FB10SH/1L + 6F20	20	15
FB10SH/1F + 6F25	25	18,5	1635	738	897	145	70	75			
FB10SH/1D + 6F30	30	22	1705	738	967	152	70	82			
FB10SH/2N + 6F35	35	26	1930	903	1027	180	91	89			
FB10SH/2L + 8F40	40	30	1979	931	1048	192	246	231	93	138	
FB10SH/2F + 8F50	50	37	2050	931	1119			246	93	153	
FB10SH/2D + 8F60	60	45	2160	931	1229			264	93	171	
FB10SH/2A + 8F70	70	51	2160	931	1229			265	93	172	
FB10SH/3F + 8F75	75	55	2445	1096	1349	240	248	298	114	184	
FB10SH/4L + 8F85	85	62	2610	1261	1349			319	135	184	
FB10SH/4G + 8F90	90	66	2680	1261	1419			340	135	205	
FB10SH/4F + 10F100	100	75	2699	1261	1438			444	139	305	
FB10SH/5F + 10F125	125	92	2994	1426	1568	240	248	506	158	348	
FB10SH/5D + 10F150	150	110	3134	1426	1708			552	158	394	
FB10SH/6D + 10F180*	180	132	3439	1591	1848			600	179	421	
FB10SH/7F + 10F180*	180	132	3604	1756	1848			621	200	421	
FB10SH/7D + 10F200*	200	150	3744	1756	1988	240	248	650	200	450	
FB10SH/7A + 10F230*	230	170	3884	1756	2128			690	200	490	

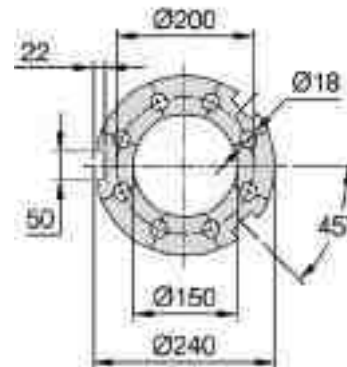

* Non consigliata per montaggio in posizione orizzontale

* This electropump isn't recommended for horizontal assemblage

* Cette électropompe n'est pas recommandée pour le montage en position horizontale

CURVE DELLE PRESTAZIONI

PERFORMANCES' CURVES

COURBES DES PERFORMANCES

FB10SH

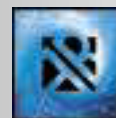

n=2900 1/min 50 Hz

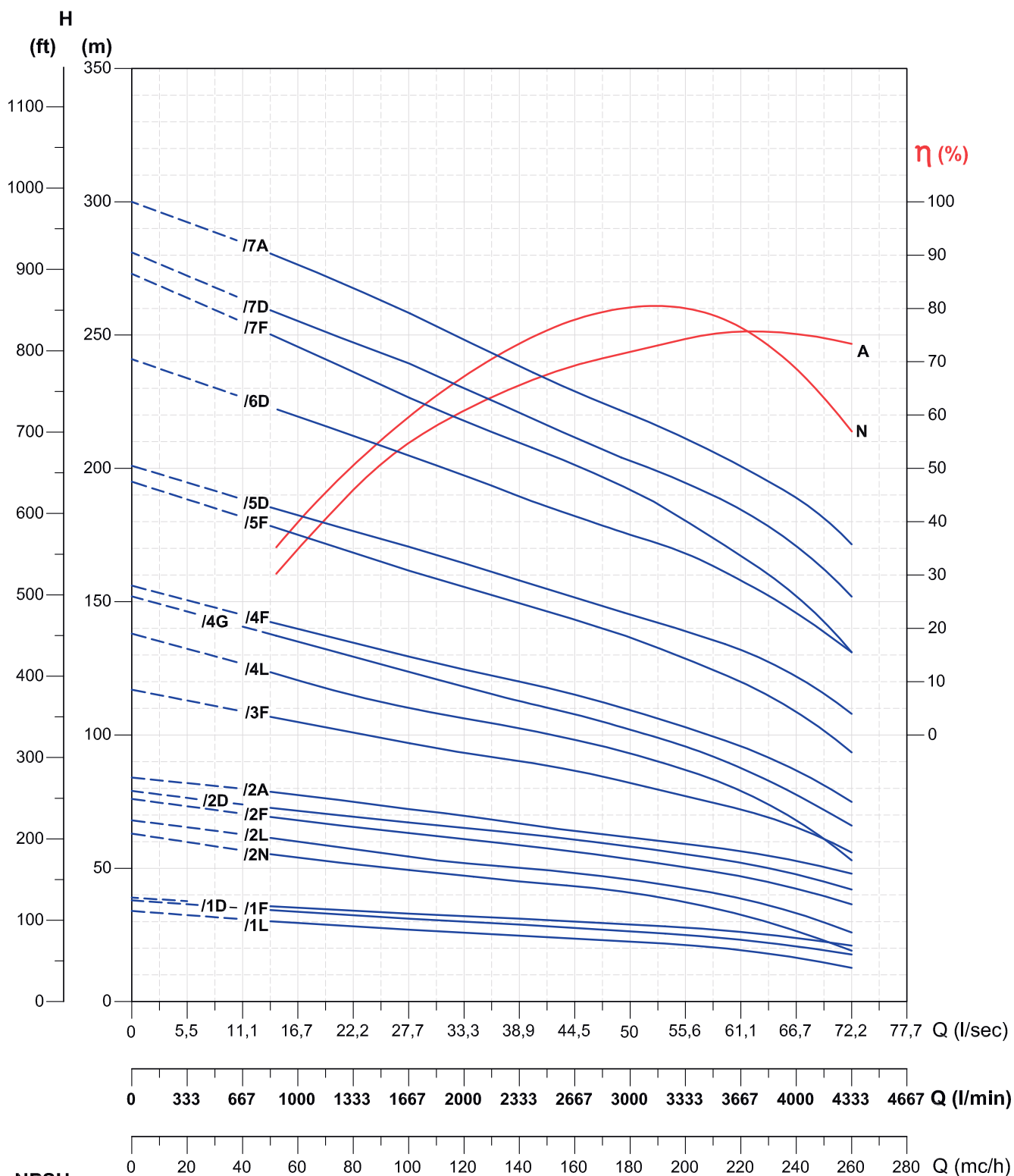

NPSH
(m)

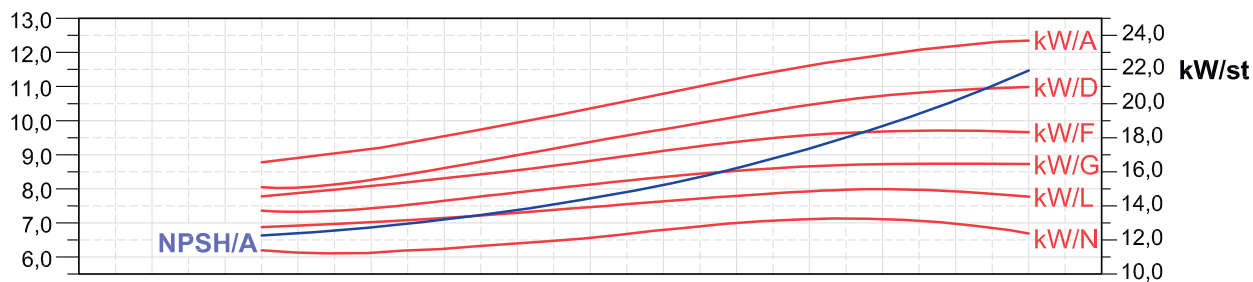

Tolleranze secondo EN ISO 9906 app.A Gr.2 - Tolerances according to EN ISO 9906 anx.A Gr.2 - Tolérances conformes EN ISO 9906 ann.A Gr.2

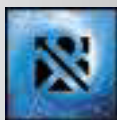

Tipo Type Type	Motore Motors 2900 g/m Moteurs		Q = Portata - Capacity - Débit									
	Cv Hp	Kw	l/sec	0	50	61,1	72,2	77,8	83,3	88,9	94,5	100
			l/min	0	3000	3667	4333	4667	5000	5333	5667	6000
			mc/h	0	180	220	260	280	300	320	340	360
FB10SL/1G + 6F35	35	26	H(m)	35	27	26	23	21	19	17	15	12
FB10SL/1A + 8F40	40	30		41	33	31	29	27	26	23	21	18
FB10SL/2N + 8F50	50	37		63	48	45	39	35	30	25		
FB10SL/2G + 8F60	60	45		72	55	52	47	43	39	35	29	23
FB10SL/2F + 8F70	70	51		75	60	58	51	47	43	38	33	26
FB10SL/2D + 8F75	75	55		77	63	59	54	51	47	43	37	31
FB10SL/2A + 8F80	80	59		82	67	63	58	55	52	47	42	36
FB10SL/3L + 8F85	85	62		106	79	74	66	60	53	45	36	
FB10SL/3G + 8F90	90	66		110	84	80	72	66	60	54	44	35
FB10SL/3F + 10F100	100	75		116	92	86	78	72	66	59	51	41
FB10SL/4G + 10F125	125	92		146	113	106	96	88	80	71	60	48
FB10SL/4D + 10F150	150	110		157	129	121	112	104	96	88	77	64
FB10SL/5G + 10F180*	180	132		183	142	133	120	110	100	89	75	60
FB10SL/6G + 10F180*	180	132		219	170	159	143	132	120	106	90	72
FB10SL/7L + 10F200*	200	150		248	183	172	154	140	124	105	84	
FB10SL/7F + 10F230*	230	170		270	214	201	182	169	154	137	119	95
FB10SL/7D + 10F260*	260	190	275	225	211	195	182	168	154	134	112	

Dimensioni e pesi

Overall dimensions and weights - Dimensions d'encombrement et poids

Tipo Type Type	Cv Hp	Kw	A (mm)	B (mm)	C (mm)	D (mm)	ø max (mm)	DN	Peso - Weight - Poids		
									A (kg)	B (kg)	C (kg)
FB10SL/1G + 6F35	35	26	1765	738	1027	145	240	150	159	70	89
FB10SL/1A + 8F40	40	30	1814	766	1048	192	246		210	72	138
FB10SL/2N + 8F50	50	37	2050	931	1119				246	93	153
FB10SL/2G + 8F60	60	45	2160	931	1229				264	93	171
FB10SL/2F + 8F70	70	51	2160	931	1229				265	93	172
FB10SL/2D + 8F75	75	55	2280	931	1349				277	93	184
FB10SL/2A + 8F80	80	59	2280	931	1349				277	93	184
FB10SL/3L + 8F85	85	63	2445	1096	1349			298	114	184	
FB10SL/3G + 8F90	90	66	2515	1096	1419	319	114	205			
FB10SL/3F + 10F100	100	75	2534	1096	1438	421	116	305			
FB10SL/4G + 10F125	125	92	2829	1261	1568	487	139	348			
FB10SL/4D + 10F150	150	110	2969	1261	1708	533	139	394			
FB10SL/5G + 10F180*	180	132	3234	1426	1808	579	158	421			
FB10SL/6G + 10F180*	180	132	3399	1591	1808	600	179	421			
FB10SL/7L + 10F200*	200	150	3684	1756	1928	650	200	450			
FB10SL/7F + 10F230*	230	170	3784	1756	2028	690	200	490			
FB10SL/7D + 10F260*	260	190	3884	1756	2128	730	200	530			

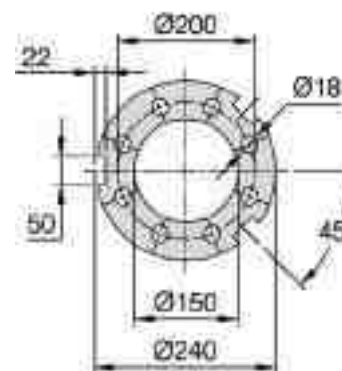
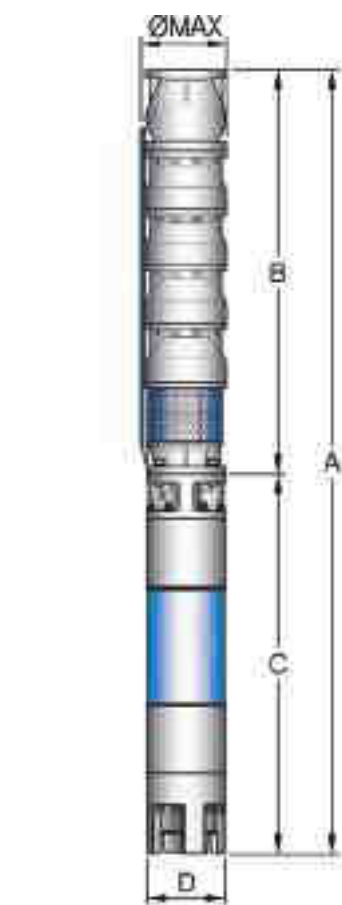

* Non consigliata per montaggio in posizione orizzontale

* This electropump isn't recommended for horizontal assemblage

* Cette électropompe n'est pas recommandée pour le montage en position horizontale

CURVE DELLE PRESTAZIONI

PERFORMANCES' CURVES

COURBES DES PERFORMANCES

FB10SL

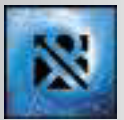

n=2900 1/min 50 Hz

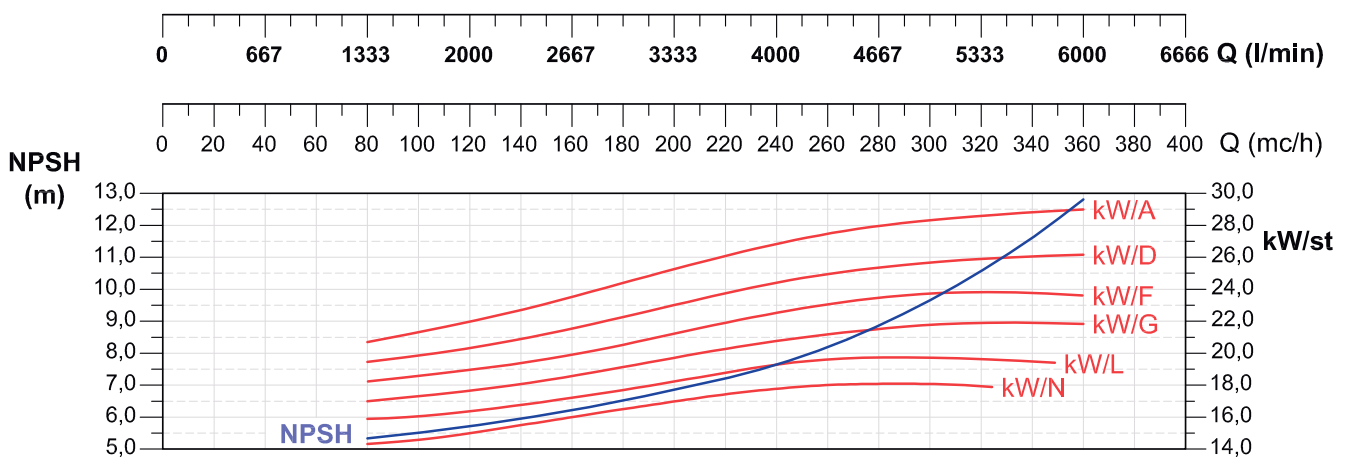
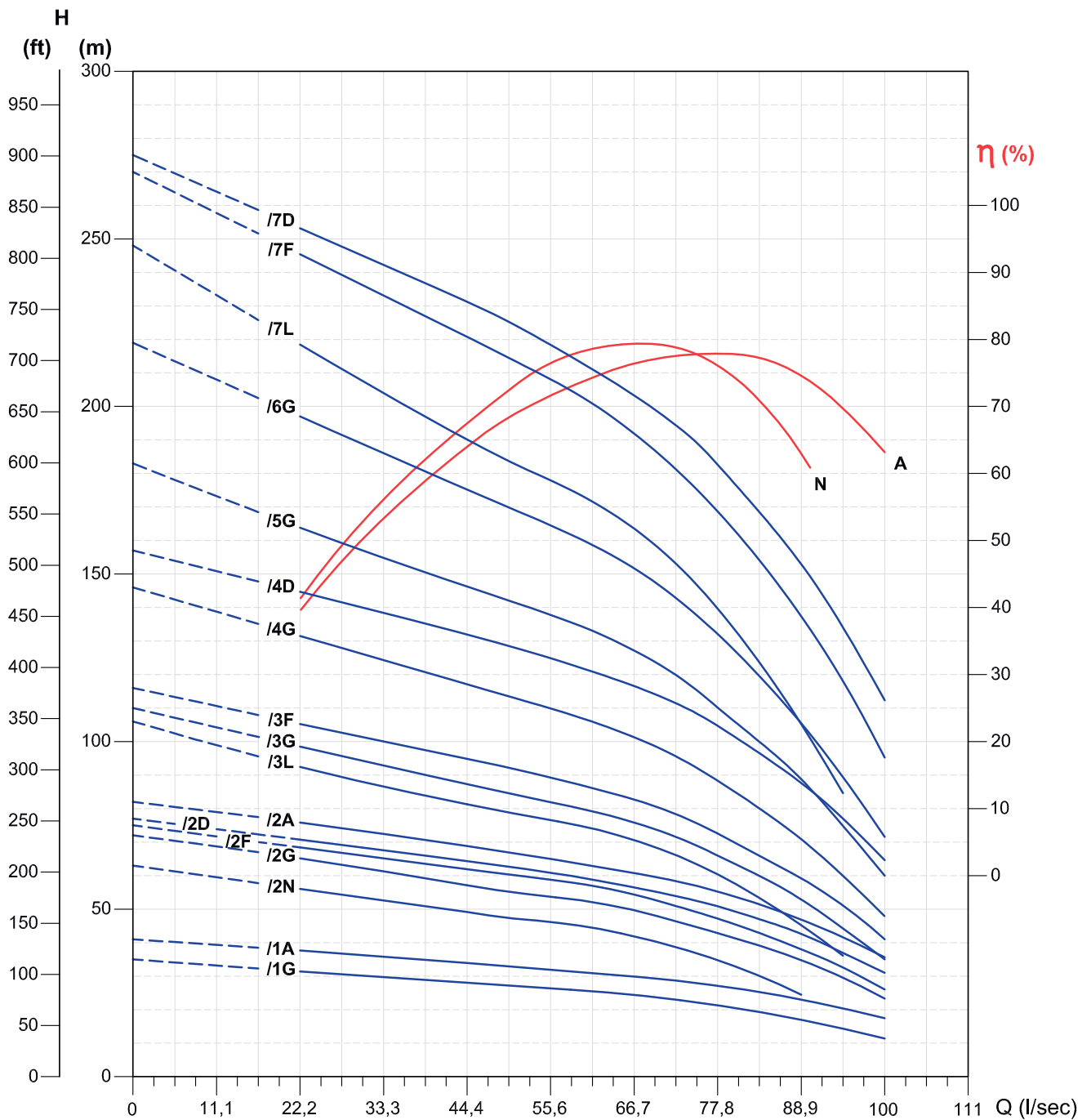

Tolleranze secondo EN ISO 9906 app.A Gr.2 - Tolerances according to EN ISO 9906 anx.A Gr.2 - Tolérances conformes EN ISO 9906 ann.A Gr.2

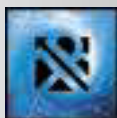

ELETTROPOMPE SOMMERSE 12" SEMIASSIALI IN GHISA

12" CAST IRON MIXED-FLOW SUBMERSIBLE ELECTROPUMPS

ÉLECTROPOMPES IMMERGÉES 12" SEMI-AXIALES EN FONTE



I corpi pompa 12" di tipo semiassiale in ghisa, serie FB12S, sono per acque pulite per pozzi 12" DN 300.

Questo tipo di pompa è costituito dalla presenza dei corpi di stadio con diffusore incorporato e delle giranti semiassiali, questa tipologia è da preferire quando si ha necessità di avere portate elevate con prevalenze medio - basse.

APPLICAZIONI:

- irrigazione
- approvvigionamento idrico
- aumento pressione
- antincendio

CONSTRUZIONE:

- girante in ghisa G25
- corpo di stadio in ghisa G25
- bocca di mandata in ghisa G25
- valvola di ritegno in ghisa G25
- albero in acciaio inox AISI 420
- copri cavo in acciaio inox AISI 304
- griglia d'aspirazione in acciaio inox AISI 304
- viteria in acciaio inox AISI 304

CARATTERISTICHE:

- portata massima: 8500 l/m
- prevalenza massima: 374 metri
- potenza massima: 190 Kw
- diametro d'ingombro massimo: 290 mm (incluso il copri cavo)
- temperatura massima dell'acqua: 60°C (solo per corpo pompa, per il motore vedi catalogo motori)
- contenuto di sabbia massimo: 100 g/m³

OPTIONAL:

Su richiesta si possono fornire corpi pompa in ghisa:

- con giranti in bronzo GCuSn10 (B10)
- con giranti in acciaio inox AISI 316



12" pumps mixed-flow type, range FB12S, are for clean water for 12" wells DN 300.

This pumps have mixed-flow impellers with diffusers combined on each stage. They may be chosen when high capacity and medium-low head are needed.

APPLICATIONS:

- irrigation
- water supply system
- pressure boosting
- fire-fighting systems

CONSTRUCTION:

- cast iron G25 impellers
- cast iron G25 delivery bowl
- cast iron G25 pump body
- cast iron G25 non-return valve
- stainless steel AISI 420 shaft
- stainless steel AISI 304 cable cover
- stainless steel AISI 304 suction strainer
- stainless steel AISI 304 nuts, bolts and screws

FEATURES:

- maximum capacity: 8500 l/m
- maximum head: 374 meters
- maximum power: 190 Kw
- maximum encumbrance diameter: 290 mm (cable cover included)
- maximum water temperature: 60°C (only for the pump, for the motor see motors' catalogue)
- maximum sand content: 100 g/m³

OPTIONAL:

On demand cast iron pumps can be manufactured with:

- bronze GCuSn10 (B10) impellers
- stainless steel AISI 316 impellers



Les pompes 12" semi-axiales en fonte, série FB12S, sont pour eaux propres pour puits de 12" DN300. Ces pompes sont caractérisées par la présence de stades avec le diffuseur incorporé et roues semi-axiales.

La gamme semi-axiale est à préférer quand il faut avoir hautes débits avec des moyennes et basses hauteurs.

APPLICATIONS:

- irrigation
- installation d'approvisionnement hydrique
- surpression
- anti incendie

CONSTRUCTION:

- roues en fonte G25
- corps d'étage en fonte G25
- orifice de refoulement en fonte G25
- crépine de non-retour en fonte G25
- arbre en acier inoxydable AISI 420
- couvre-câble en acier inoxydable AISI 304
- crépine d'aspiration en acier inoxydable AISI 304
- visserie en acier inoxydable AISI 304

CARACTÉRISTIQUES:

- débit maximum: 8500 l/m
- hauteur maximale: 374 mètres
- puissance maximale: 190 Kw
- diamètre d'encombrement maximum: 290 mm (inclus le couvre-câble)
- température maximale de l'eau: 60°C (pour la pompe, pour le moteur voir le catalogue des moteurs)
- quantité maximale de sable: 100 g/m³

OPTIONAL:

Sur demande on peut fournir pompes en fonte:

- avec roues en bronze GCuSn10 (B10)
- avec roues en acier inoxydable AISI 316



ELETTROPOMPE SOMMERSE 12" SEMIASSIALI IN BRONZO

12" BRONZE MIXED-FLOW SUBMERSIBLE ELECTROPUMPS

ÉLECTROPOMPES IMMERGÉES 12" SEMI-AXIALES EN BRONZE

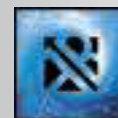

APPLICAZIONI:

- irrigazione, approvvigionamento idrico, aumento pressione ed antincendio
- acqua di mare
- acque salmastre

COSTRUZIONE:

- girante in bronzo GCuSn10 (B10)
- corpo di stadio in bronzo GCuSn10 (B10)
- bocca di mandata in bronzo GCuSn10 (B10)
- valvola di ritegno in bronzo GCuSn10 (B10)
- albero in acciaio inox AISI 316
- copri cavo in acciaio inox AISI 316
- griglia d'aspirazione in acciaio inox AISI 316
- viteria in acciaio inox AISI 316

CARATTERISTICHE:

- portata massima: 8500 l/m
- prevalenza massima: 374 metri
- potenza massima: 190 Kw
- diametro d'ingombro massimo: 290 mm (incluso il copri cavo)
- temperatura massima dell'acqua: 60°C (solo per corpo pompa, per il motore vedi catalogo motori)
- contenuto di sabbia massimo: 100 g/m³



APPLICATIONS:

- irrigation, water supply system, pressure boosting and fire-fighting systems
- sea water
- brackish water

CONSTRUCTION:

- bronze GCuSn10 (B10) impellers
- bronze GCuSn10 (B10) delivery bowl
- bronze GCuSn10 (B10) pump body
- bronze GCuSn10 (B10) non-return valve
- stainless steel AISI 316 shaft
- stainless steel AISI 316 cable cover
- stainless steel AISI 316 suction strainer
- stainless steel AISI 316 nuts, bolts and screws

FEATURES:

- maximum capacity: 8500 l/m
- maximum head: 374 meters
- maximum power: 190 Kw
- maximum encumbrance diameter: 290 mm (cable cover included)
- maximum water temperature: 60°C (only for the pump, for the motor see motors' catalogue)
- maximum sand content: 100 g/m³



APPLICATIONS:

- irrigation, installation d'approvisionnement hydrique, surpression et anti incendie
- eau de mer
- eau saumâtre

CONSTRUCTION:

- roues en bronze GCuSn10 (B10)
- corps d'étage en bronze GCuSn10 (B10)
- orifice de refoulement bronze GCuSn10 (B10)
- crépine de non-retour en bronze GCuSn10 (B10)
- arbre en acier inoxydable AISI 316
- couvre-câble en acier inoxydable AISI 316
- crépine d'aspiration en acier inoxydable AISI 316
- visserie en acier inoxydable AISI 316

CARACTÉRISTIQUES:

- débit maximum: 8500 l/m
- hauteur maximale: 374 mètres
- puissance maximale: 190 Kw
- diamètre d'encombrement maximum: 290 mm (inclus le couvre-câble)
- température maximale de l'eau: 60°C (pour la pompe, pour le moteur voir le catalogue des moteurs)
- quantité maximale de sable: 100 g/m³



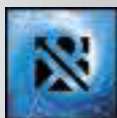

ELETTROPOMPE SOMMERSE 12" SEMIASSIALI IN ACCIAIO INOX AISI 316 E DUPLEX

12" STAINLESS STEEL AISI 316 AND DUPLEX MIXED-FLOW SUBMERSIBLE ELECTROPUMPS

ÉLECTROPOMPES IMMERGÉES 12" SEMI-AXIALES EN ACIER INOXYDABLE AISI 316 ET DUPLEX



APPLICAZIONI:

- irrigazione, approvvigionamento idrico, aumento pressione ed antincendio
- acqua potabile
- acque di mare
- acque salmastre
- acque termali e sulfuree
- desalinizzazione ed osmosi
- acque aggressive e corrosive
- vari settori dell'industria: alimentare, petrolchimica, siderurgica e navale
- applicazioni gravose: miniera

CONSTRUZIONE IN ACCIAIO INOX AISI 316:

PREN 26 (Pitting Resistance Equivalent)

- girante in acciaio inox AISI 316 (W. Nr. 1.4401)
- corpo di stadio in acciaio inox AISI 316 (W. Nr. 1.4401)
- bocca di mandata in acciaio inox AISI 316 (W. Nr. 1.4401)
- valvola di ritegno in acciaio inox AISI 316 (W. Nr. 1.4401)
- albero in acciaio inox AISI 316 (W. Nr. 1.4401)
- copri cavo in acciaio inox AISI 316 (W. Nr. 1.4401)
- griglia d'aspirazione in acciaio inox AISI 316 (W. Nr. 1.4401)
- viteria in acciaio inox AISI 316 (W. Nr. 1.4401)

CONSTRUZIONE IN ACCIAIO INOX DUPLEX:

PREN 31 (Pitting Resistance Equivalent)

- girante in acciaio inox duplex (W. Nr. 1.4462)
- corpo di stadio in acciaio inox duplex (W. Nr. 1.4462)
- bocca di mandata in acciaio inox duplex (W. Nr. 1.4462)
- valvola di ritegno in acciaio inox duplex (W. Nr. 1.4462)
- albero in acciaio inox duplex (W. Nr. 1.4462)
- copri cavo in acciaio inox duplex (W. Nr. 1.4462)
- griglia d'aspirazione in acciaio inox duplex (W. Nr. 1.4462)
- viteria in acciaio inox duplex (W. Nr. 1.4462)

CARATTERISTICHE:

- portata massima: 8500 l/m
- prevalenza massima: 374 metri
- potenza massima: 190 Kw
- diametro d'ingombro massimo: 290 mm (incluso il copri cavo)
- temperatura massima dell'acqua: 60°C (solo per corpo pompa, per il motore vedi catalogo motori)
- contenuto di sabbia massimo: 100 g/m³



APPLICATIONS:

- irrigation, water supply system, pressure boosting, fire-fighting systems
- sea water
- brackish water
- drinking water
- thermal and sulphurous water
- desalinization and osmosis
- aggressive and corrosive waters
- different sectors of the industry: such as food, petrochemical, steel and shipbuilding
- hard applications: mine

STAINLESS STEEL AISI 316 CONSTRUCTION:

PREN 26 (Pitting Resistance Equivalent)

- stainless steel AISI 316 (W. Nr. 1.4401) impellers
- stainless steel AISI 316 (W. Nr. 1.4401) delivery bowl
- stainless steel AISI 316 (W. Nr. 1.4401) pump body
- stainless steel AISI 316 (W. Nr. 1.4401) non-return valve
- stainless steel AISI 316 (W. Nr. 1.4401) shaft
- stainless steel AISI 316 (W. Nr. 1.4401) cable cover
- stainless steel AISI 316 (W. Nr. 1.4401) suction strainer
- stainless steel AISI 316 (W. Nr. 1.4401) nuts, bolts and screws

STAINLESS STEEL DUPLEX CONSTRUCTION:

PREN 31 (Pitting Resistance Equivalent)

- stainless steel duplex (W. Nr. 1.4462) impellers
- stainless steel duplex (W. Nr. 1.4462) delivery bowl
- stainless steel duplex (W. Nr. 1.4462) pump body
- stainless steel duplex (W. Nr. 1.4462) non-return valve
- stainless steel duplex (W. Nr. 1.4462) shaft
- stainless steel duplex (W. Nr. 1.4462) cable cover
- stainless steel duplex (W. Nr. 1.4462) suction strainer
- stainless steel duplex (W. Nr. 1.4462) nuts, bolts and screws

FEATURES:

- maximum capacity: 8500 l/m
- maximum head: 374 meters
- maximum power: 190 Kw
- maximum encumbrance diameter: 290 mm (cable cover included)
- maximum water temperature: 60°C (only for the pump, for the motor see motors' catalogue)
- maximum sand content: 100 g/m³



APPLICATIONS:

- irrigation, installation d'approvisionnement hydrique, surpression et anti incendie
- eau potable
- eau de mer
- eau saumâtre
- eau thermale e sulfureuse
- dessalement et osmose
- eau agressive et corrosives
- différents secteurs de l'industrie: alimentaire, pétrochimie, sidérurgique et navale
- applications dures: mine

CONSTRUCTION EN ACIER INOXYDABLE AISI 316

PREN 26 (Pitting Resistance Equivalent)

- roues en acier inoxydable AISI 316 (W. Nr. 1.4401)
- corps d'étage en acier inoxydable AISI 316 (W. Nr. 1.4401)
- orifice de refoulement en acier inoxydable AISI 316 (W. Nr. 1.4401)
- crépine de non-retour en acier inoxydable AISI 316 (W. Nr. 1.4401)
- arbre en acier inoxydable AISI 316 (W. Nr. 1.4401)
- couvre-câble en acier inoxydable AISI 316 (W. Nr. 1.4401)
- crépine d'aspiration en acier inoxydable AISI 316 (W. Nr. 1.4401)
- visserie en acier inoxydable AISI 316 (W. Nr. 1.4401)

CONSTRUCTION EN ACIER INOXYDABLE DUPLEX

PREN 31 (Pitting Resistance Equivalent)

- roues en acier inoxydable duplex (W. Nr. 1.4462)
- corps d'étage en acier inoxydable duplex (W. Nr. 1.4462)
- orifice de refoulement en acier inoxydable duplex (W. Nr. 1.4462)
- crépine de non-retour en acier inoxydable duplex (W. Nr. 1.4462)
- arbre en acier inoxydable duplex (W. Nr. 1.4462)
- couvre-câble en acier inoxydable duplex (W. Nr. 1.4462)
- crépine d'aspiration en acier inoxydable duplex (W. Nr. 1.4462)
- visserie en acier inoxydable duplex (W. Nr. 1.4462)

CARACTÉRISTIQUES:

- débit maximum: 8500 l/m
- hauteur maximale: 374 mètres
- puissance maximale: 190 Kw
- diamètre d'encombrement maximum: 290 mm (inclus le couvre-câble)
- température maximale de l'eau: 60°C (pour la pompe, pour le moteur voir le catalogue des moteurs)
- quantité maximale de sable: 100 g/m³



SPACCATO 12"

12" CUTAWAY
COUPE 12"

FB12S

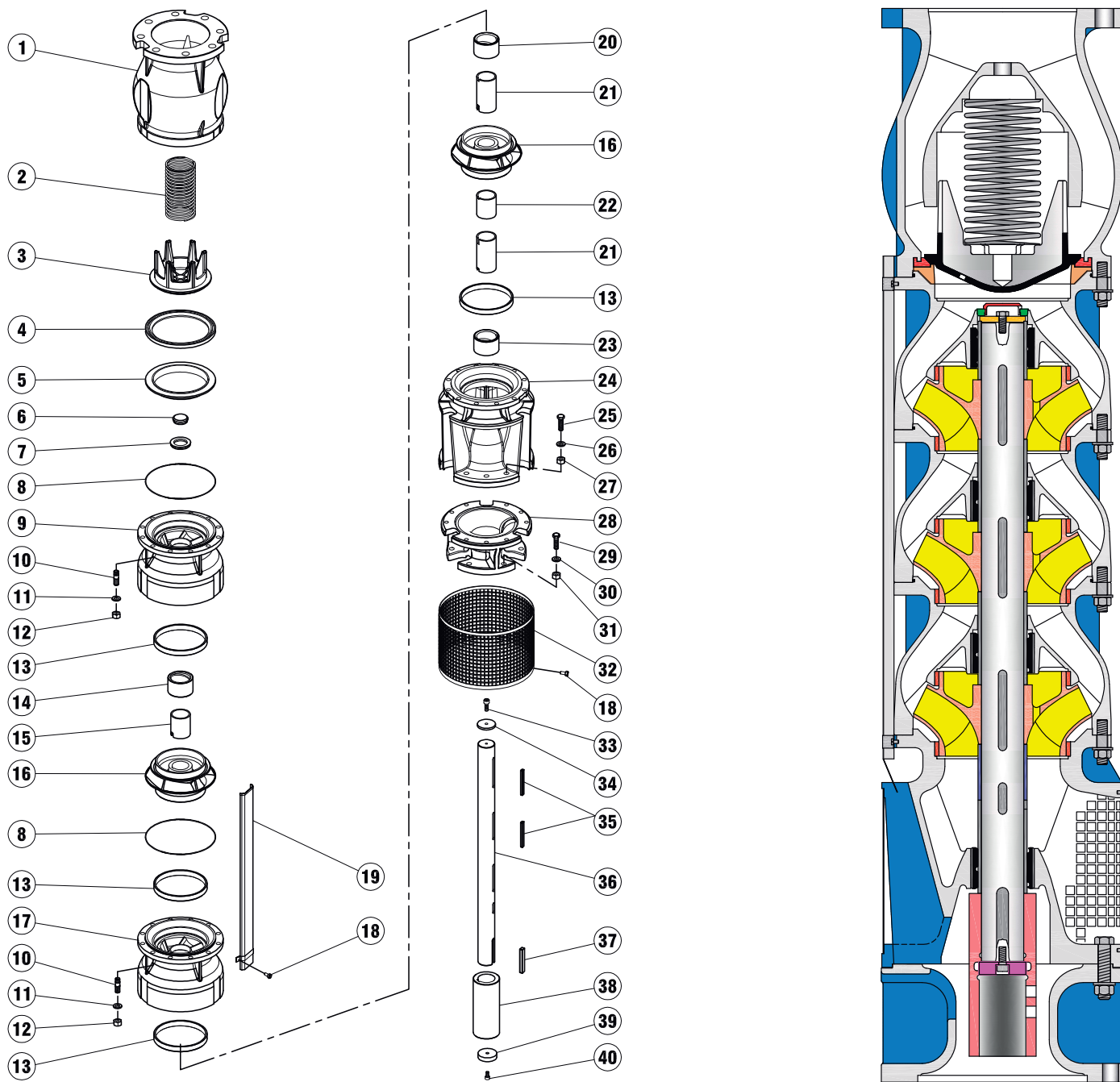
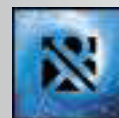

Pos.	Qt.	Denominazione	Denomination	Denomination
1	1	Corpo della valvola	Valve body	Corps de clapet
2	1	Molla della valvola	Valve spring	Ressort de soupape
3	1	Otturatore della valvola	Wing valve	Soupape du clapet
4	1	Sede valvola	Valve seat	Siège de soupape
5	1	Anello di raccordo	Valve insert ring	Bague
6	1	Coperchio di protezione	Vent plug	Bouchon de purge d'air
7	1	Anello di riduzione	Ring	Bague
8	*N-1	Guarnizione corpo	Joint for stage casing	Joint du corps d'étage
9	1	Corpo raddrizzatore	Pump bowl	Corps redresseur
10	*Nx12	Prigioniero	Stud	Goujon
11	*Nx12	Rosetta	Washer	Rondelle
12	*Nx12	Dado	Nut	Ecrou
13	*Nx2	Anello di usura fisso	Casing wear ring	Bague d'usure
14	1	Cuscinetto a boccia	Bearing bush	Coussinet
15	1	Bussola distanziale	Bearing sleeve	Chemise d'arbre
16	*N	Girante	Impeller	Roue
17	*N	Corpo raddrizzatore	Pump bowl	Corps redresseur
18	6-14	Vite	Screw	Vis
19	1-2	Tegolo protezione cavo	Cable guard	Protège-cable
20	*N	Bussola intermedia	Interstage bush	Douille entre étages

Pos.	Qt.	Denominazione	Denomination	Denomination
21	*N-1	Bussola intermedia	Interstage sleeve	Chemise entretroise
22	1	Bussola distanziale	Bearing sleeve	Chemise d'arbre
23	1	Cuscinetto a boccia	Bearing bush	Coussinet
24	1	Camera aspirante	Suction casing	Corps d'aspiration
25	9	Vite	Screw	Vis
26	9	Rosetta	Washer	Rondelle
27	9	Dado	Nut	Ecrou
28	1	Tronchetto di raccordo	Connecting piece	Manchette de raccordo
29	6	Vite	Screw	Vis
30	6	Rosetta	Washer	Rondelle
31	6	Dado	Nut	Ecrou
32	1	Griglia d'aspirazione	Suction strainer	Crépine d'aspiration
33	1	Vite	Screw	Vis
34	1	Rosetta ghiera albero	Washer for shaft nut	Rondelle
35	*Nx2	Linguetta girante	Key for impeller	Clavette de la roue
36	1	Anello pompa	Pump shaft	Arbre de pompe
37	1	Linguetta giunto	Key for coupling	Clavette pour accoupl.
38	1	Giunto	Coupling	Accouplement
39	1	Disco di spinta	Thrust insert	Vis de butée accoupl.
40	1	Vite	Screw	Vis

*N=Numero di scatole e giranti variabili dal tipo di pompa

*N=The number of the boxer and the impellers vary according to the type of the pump.

*N=Numéro d'enveloppes et roues selon le type de pompe.



TABELLA DELLE CARATTERISTICHE IDRAULICHE 12"

12" HYDRAULIC FEATURES' CHART

TABLE DES CARACTÉRISTIQUES HYDRAULIQUES 12"

Tipo Type Type	Motore Motor Moteur		Q = Portata - Capacity - Débit																				
			l/sec	0	44,5	50	55,6	61,1	66,7	72,2	77,8	83,3	88,9	94,5	100								
	l/min	0	2667	3000	3333	3667	4000	4333	4667	5000	5333	5667	6000										
	Hp	Kw	mc/h	0	160	180	200	220	240	260	280	300	320	340	360								
FB12SE/1F	30	22	H(m)	44	31	29	27	25	23	20	16	11											
FB12SE/1A	35	26		48	35	33	32	30	28	25	22	18	13										
FB12SE/2N	40	30		73	47	44	40	36	31	24													
FB12SE/2L	50	37		78	53	49	45	41	35	29	22												
FB12SE/2F	60	45		88	63	59	55	51	46	40	32	23											
FB12SE/2A	70	51		97	71	68	64	61	56	51	44	36	27										
FB12SE/3L	75	55		119	81	75	69	63	54	44	34												
FB12SE/3G	80	59		126	87	83	77	70	62	53	42	30											
FB12SE/3F	85	62		135	96	90	85	78	70	61	50	35											
FB12SE/3A	100	75		148	109	103	98	93	86	78	67	55	42										
FB12SE/4D	125	92		187	136	129	122	113	104	92	79	60	39										
FB12SE/5D	150	110		234	170	161	153	142	130	116	99	75	49										
FB12SE/6F	180	132		270	192	180	168	156	138	121	96	68											
FB12SE/7F	200	150		315	223	210	197	182	163	141	116	81											
FB12SE/8F	230	170		360	255	240	226	208	186	162	132	92											
FB12SE/8D	260	190		374	272	258	244	226	208	185	158	120	78										
FB12SG/1G	30	22	H(m)	43			28	27	25	24	22	19	17	14									
FB12SG/1F	35	26		47			30	29	28	26	25	23	20	17	15								
FB12SG/1D	40	30		49			33	31	30	29	27	25	23	20	17								
FB12SG/2N	50	37		74			47	46	41	37	32	27	21	15									
FB12SG/2G	60	45		87			57	54	51	48	44	39	34	28									
FB12SG/2F	70	51		95			61	59	57	53	51	46	40	34	30								
FB12SG/2D	75	55		100			66	63	61	58	55	51	46	41	35								
FB12SG/2A	80	59		104			70	67	65	62	59	55	51	46	41								
FB12SG/3L	85	62		124			80	75	71	65	58	51	43										
FB12SG/3G	90	66		133			87	83	78	73	67	60	52	43									
FB12SG/3F	100	75		145			94	90	87	82	76	70	63	54	45								
FB12SG/3A	125	92		160			107	103	99	95	90	85	78	71	63								
FB12SG/4D	150	110		204			134	129	124	118	112	104	94	84	72								
FB12SG/5F	180	132		243			156	149	143	136	125	116	104	89	73								
FB12SG/6G	180	132		268			174	165	157	147	134	120	104	87									
FB12SG/6F	200	150		291			187	180	174	164	152	140	126	108	90								
FB12SG/6D	230	170	306			202	193	186	177	168	156	142	126	108									
FB12SG/7D	260	190	357			235	225	217	207	196	182	165	147	126									

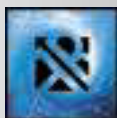
TABELLA DELLE CARATTERISTICHE IDRAULICHE 12"

12" HYDRAULIC FEATURES' CHART

TABLE DES CARACTÉRISTIQUES HYDRAULIQUES 12"

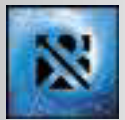

n=2900 1/min 50 Hz

Tipo Type Type	Motore Motor Moteur		Q = Portata - Capacity - Débit																			
			l/sec	0	55,6	61,1	66,7	72,2	77,8	83,3	88,9	94,5	100	105,6	111,1	122,2	133,3	141,7				
	l/min	0	3333	3667	4000	4333	4667	5000	5333	5667	6000	6333	6667	7333	8000	8500						
	Hp	Kw	mc/h	0	200	220	240	260	280	300	320	340	360	380	400	440	480	510				
FB12SH/1N	35	26		36	27	26	25	24	22	21	19	17	14	12	9							
FB12SH/1L	40	30		40	29	28	27	26	25	24	22	20	18	16	12							
FB12SH/1D	50	37		48	36	35	35	34	33	32	30	29	27	25	22							
FB12SH/1A	60	45		49	38	37	36	36	35	34	32	31	29	27	25							
FB12SH/2L	70	51		81	59	57	55	53	51	48	44	40	36	32	24							
FB12SH/2G	80	59		86	65	62	61	59	57	54	51	47	42	38	33							
FB12SH/2F	85	62		92	69	67	65	64	62	59	57	53	49	45	40							
FB12SH/3N	90	66	H(m)	112	83	80	77	73	69	66	59	52	45	36	27							
FB12SH/3L	100	75		123	90	87	83	80	76	71	67	62	56	50	42							
FB12SH/3G	125	92		132	99	95	93	90	87	83	78	72	65	58	50							
FB12SH/3D	150	110		147	113	109	107	104	102	99	94	89	84	77	69							
FB12SH/4F	180	132		188	141	136	134	130	126	121	115	108	101	92	82							
FB12SH/5G	200	150		220	164	159	155	150	145	138	130	120	109	97	83							
FB12SH/5F	230	170		235	177	171	166	162	159	152	144	135	126	115	102							
FB12SH/6F	260	190		282	212	205	200	195	190	182	173	162	151	138	122							
FB12SL/1L	50	37		40				30	29	28	27	26	25	23	22	17	13					
FB12SL/1F	60	45		47				35	34	33	32	32	31	30	29	26	21	16				
FB12SL/1A	75	55		49				39	38	37	37	36	36	35	33	30	26	22				
FB12SL/2N	85	62		74				55	53	51	49	47	45	42	39	30	19					
FB12SL/2L	90	66		81				60	58	57	55	53	50	47	44	35	26					
FB12SL/2G	100	75		88				66	64	62	60	58	55	53	51	44	35	30				
FB12SL/2D	125	92	H(m)	97				75	72	71	69	68	66	64	62	56	48	40				
FB12SL/3G	150	110		134				100	97	95	91	89	85	81	78	67	54	43				
FB12SL/3F	180	132		145				107	104	102	101	99	96	93	88	79	65	51				
FB12SL/3D	200	150		149				114	112	109	106	104	101	98	95	87	73	60				
FB12SL/4F	230	170		193				142	138	136	134	132	128	124	118	106	86	68				
FB12SL/5G	260	190		224				167	163	158	153	148	141	135	130	112	90					

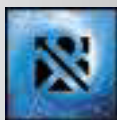

Tipo Type Type	Motore Motors Moteurs		Q = Portata - Capacity - Débit									
	Cv Hp	Kw	l/sec	0	44,5	55,6	61,1	66,7	72,2	77,8	83,3	88,9
			l/min	0	2667	3333	3667	4000	4333	4667	5000	5333
		mc/h	0	160	200	220	240	260	280	300	320	
FB12SE/1F + 8F30	30	22	H(m)	44	31	27	25	23	20	16	11	
FB12SE/1A + 8F35	35	26		48	35	32	30	28	25	22	18	13
FB12SE/2N + 8F40	40	30		73	47	40	36	31	24			
FB12SE/2L + 8F50	50	37		78	53	45	41	35	29	22		
FB12SE/2F + 8F60	60	45		88	63	55	51	46	40	32	23	
FB12SE/2A + 8F70	70	51		97	71	64	61	56	51	44	36	27
FB12SE/3L + 8F75	75	55		119	81	69	63	54	44	34		
FB12SE/3G + 8F80	80	59		126	87	77	70	62	53	42	30	
FB12SE/3F + 8F85	85	62		135	96	85	78	70	61	50	35	
FB12SE/3A + 10F100	100	75		148	109	98	93	86	78	67	55	42
FB12SE/4D + 10F125	125	92		187	136	122	113	104	92	79	60	39
FB12SE/5D + 10F150	150	110		234	170	153	142	130	116	99	75	49
FB12SE/6F + 10F180*	180	132		270	192	168	156	138	121	96	68	
FB12SE/7F + 10F200*	200	150		315	223	197	182	163	141	116	81	
FB12SE/8F + 10F230*	230	170		360	255	226	208	186	162	132	92	
FB12SE/8D + 10F260*	260	190		374	272	244	226	208	185	158	120	78

Dimensioni e pesi

Overall dimensions and weights - Dimensions d'encombrement et poids

Tipo Type Type	Cv Hp	Kw	A (mm)	B (mm)	C (mm)	D (mm)	ø max (mm)	DN	Peso - Weight - Poids		
									A (kg)	B (kg)	C (kg)
FB12SE/1F + 8F30	30	22	1860	881	979	192	290	175	247	115	132
FB12SE/1A + 8F35	35	26	1930	881	1049				251	115	136
FB12SE/2N + 8F40	40	30	2110	1061	1049				280	142	138
FB12SE/2L + 8F50	50	37	2180	1061	1119				295	142	153
FB12SE/2F + 8F60	60	45	2290	1061	1229				313	142	171
FB12SE/2A + 8F70	70	51	2290	1061	1229				314	142	172
FB12SE/3L + 8F75	75	55	2590	1241	1349				353	169	184
FB12SE/3G + 8F80	80	59	2590	1241	1349				353	169	184
FB12SE/3F + 8F85	85	62	2590	1241	1349				353	169	184
FB12SE/3A + 10F100	100	75	2679	1241	1438				479	174	305
FB12SE/4D + 10F125	125	92	2989	1421	1568				549	201	348
FB12SE/5D + 10F150	150	110	3309	1601	1708				622	228	394
FB12SE/6F + 10F180*	180	132	3487	1679	1808				676	255	421
FB12SE/7F + 10F200*	200	150	3889	1961	1928				732	282	450
FB12SE/8F + 10F230*	230	170	4169	2141	2028				799	309	490
FB12SE/8D + 10F260*	260	190	4269	2141	2128				839	309	530

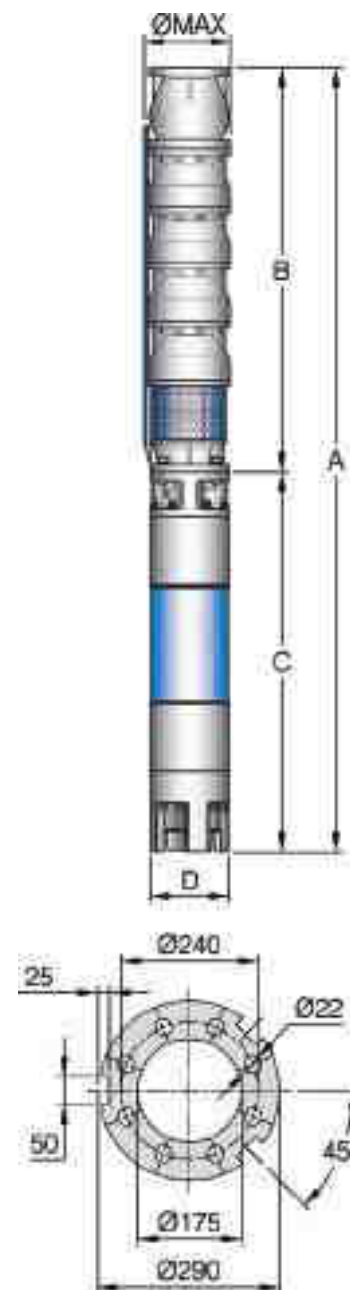

* Non consigliata per montaggio in posizione orizzontale

* This electropump isn't recommended for horizontal assemblage

* Cette électropompe n'est pas recommandée pour le montage en position horizontale

CURVE DELLE PRESTAZIONI

PERFORMANCES' CURVES
COURBES DES PERFORMANCES

FB12SE

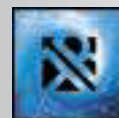

n=2900 1/min 50 Hz

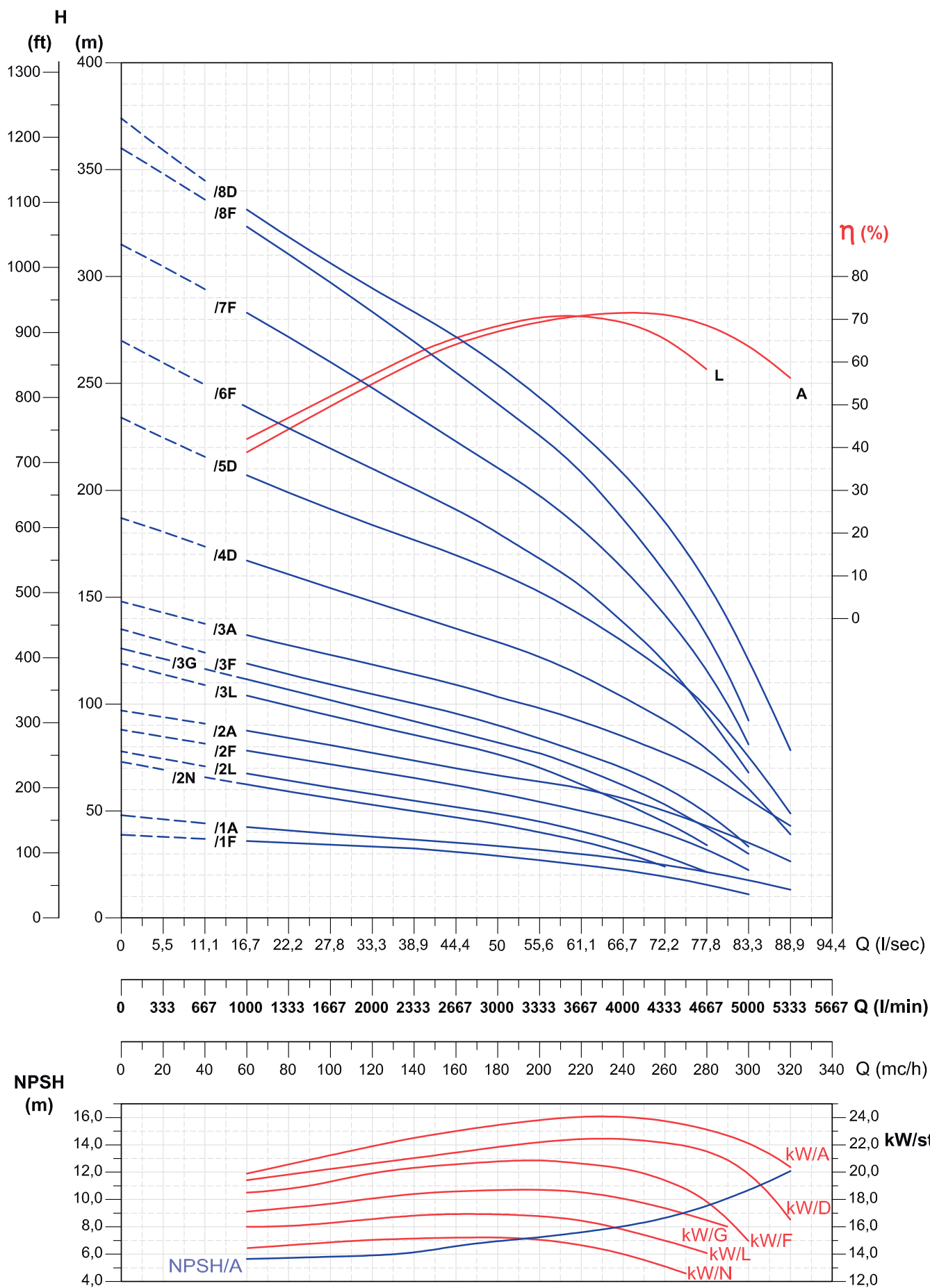

Tolleranze secondo EN ISO 9906 app.A Gr.2 - Tolerances according to EN ISO 9906 anx.A Gr.2 - Tolérances conformes EN ISO 9906 ann.A Gr.2

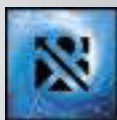

Tipo Type Type	Motore Motors 2900 g/m Moteurs		Q = Portata - Capacity - Débit											
			Cv Hp	Kw	l/sec	0	55,6	66,7	72,2	77,8	83,3	88,9	94,5	100
					l/min	0	3333	4000	4333	4667	5000	5333	5667	6000
					mc/h	0	200	240	260	280	300	320	340	360
FB12SG/1G + 8F30	30	22	43	28	25	24	22	19	17	14				
FB12SG/1F + 8F35	35	26	47	30	28	26	25	23	20	17	15			
FB12SG/1D + 8F40	40	30	49	33	30	29	27	25	23	20	17			
FB12SG/2N + 8F50	50	37	74	47	41	37	32	27	21	15				
FB12SG/2G + 8F60	60	45	87	57	51	48	44	39	34	28				
FB12SG/2F + 8F70	70	51	95	61	57	53	51	46	40	34	30			
FB12SG/2D + 8F75	75	55	100	66	61	58	55	51	46	41	35			
FB12SG/2A + 8F80	80	59	104	70	65	62	59	55	51	46	41			
FB12SG/3L + 8F85	85	62	124	80	71	65	58	51	43					
FB12SG/3G + 8F90	90	66	133	87	78	73	67	60	52	43				
FB12SG/3F + 10F100	100	75	145	94	87	82	76	70	63	54	45			
FB12SG/3A + 10F125	125	92	160	107	99	95	90	85	78	71	63			
FB12SG/4D + 10F150	150	110	204	134	124	118	112	104	94	84	72			
FB12SG/5F + 10F180*	180	132	243	156	143	136	125	116	104	89	73			
FB12SG/6G + 10F180*	180	132	268	174	157	147	134	120	104	87				
FB12SG/6F + 10F200*	200	150	291	187	174	164	152	140	126	108	90			
FB12SG/6D + 10F230*	230	170	306	202	186	177	168	156	142	126	108			
FB12SG/7D + 10F260*	260	190	357	235	217	207	196	182	165	147	126			

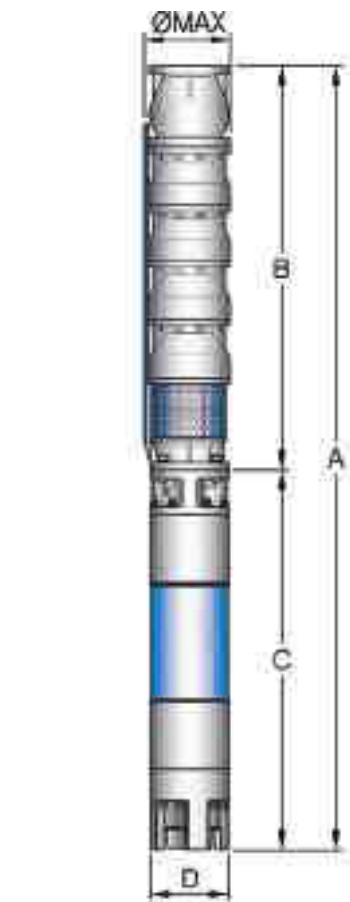

Dimensioni e pesi

Overall dimensions and weights - Dimensions d'encombrement et poids

Tipo Type Type	Cv Hp	Kw	A (mm)	B (mm)	C (mm)	D (mm)	ø max (mm)	DN	Peso - Weight - Poids		
									A (kg)	B (kg)	C (kg)
									FB12SG/1G + 8F30	30	22
FB12SG/1F + 8F35	35	26	1930	881	1049				251	115	136
FB12SG/1D + 8F40	40	30	1930	881	1049				253	115	138
FB12SG/2N + 8F50	50	37	2180	1061	1119				295	142	153
FB12SG/2G + 8F60	60	45	2290	1061	1229			192	313	142	171
FB12SG/2F + 8F70	70	51	2290	1061	1229				314	142	172
FB12SG/2D + 8F75	75	55	2410	1061	1349				326	142	184
FB12SG/2A + 8F80	80	59	2410	1061	1349				326	142	184
FB12SG/3L + 8F85	85	62	2590	1241	1349				353	169	184
FB12SG/3G + 8F90	90	66	2660	1241	1419			290	374	169	205
FB12SG/3F + 10F100	100	75	2679	1241	1438				479	174	305
FB12SG/3A + 10F125	125	92	2809	1241	1568				522	174	348
FB12SG/4D + 10F150	150	110	3129	1421	1708				595	201	394
FB12SG/5F + 10F180*	180	132	3409	1601	1808				649	228	421
FB12SG/6G + 10F180*	180	132	3589	1781	1808			240	676	255	421
FB12SG/6F + 10F200*	200	150	3709	1781	1928				705	255	450
FB12SG/6D + 10F230*	230	170	3809	1781	2028				745	255	490
FB12SG/7D + 10F260*	260	190	4089	1961	2128				812	282	530

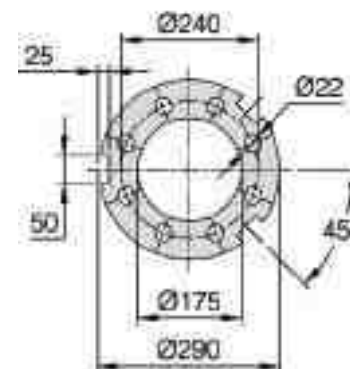

* Non consigliata per montaggio in posizione orizzontale

* This electropump isn't recommended for horizontal assemblage

* Cette électropompe n'est pas recommandée pour le montage en position horizontale

CURVE DELLE PRESTAZIONI

PERFORMANCES' CURVES

COURBES DES PERFORMANCES

FB12SG

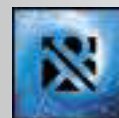

n=2900 1/min 50 Hz

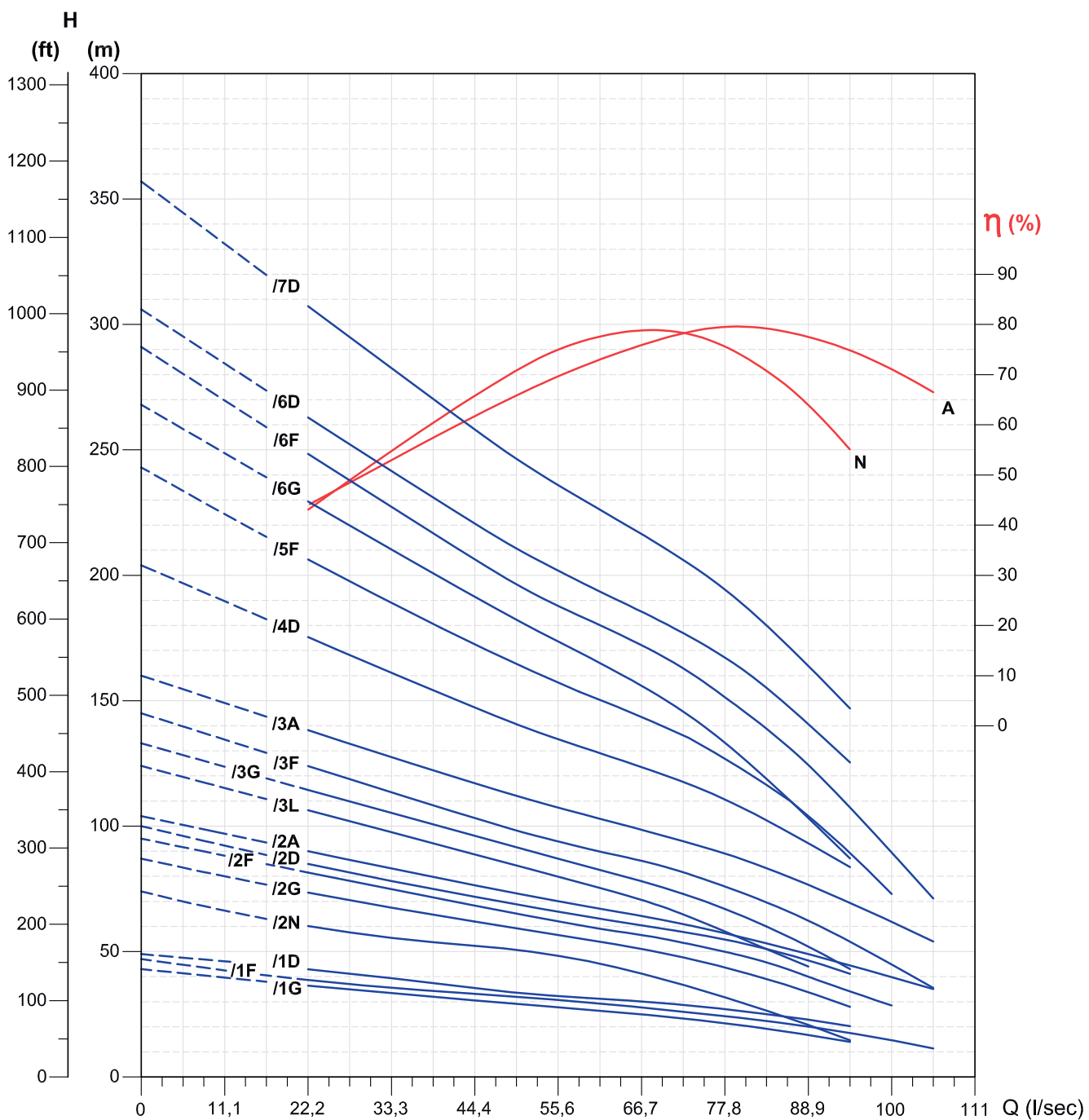

NPSH

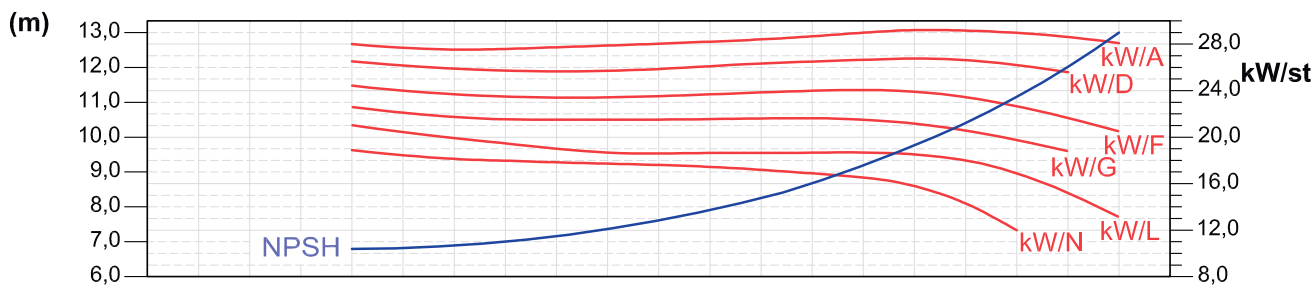

Tolleranze secondo EN ISO 9906 app.A Gr.2 - Tolerances according to EN ISO 9906 anx.A Gr.2 - Tolérances conformes EN ISO 9906 ann.A Gr.2

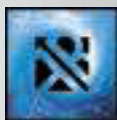

Tipo Type Type	Motore Motors 2900 g/m Moteurs		Q = Portata - Capacity - Débit									
	Cv Hp	Kw	l/sec	0	55,6	69,5	83,3	88,9	94,5	100	105,6	111,1
			l/min	0	3333	4167	5000	5333	5667	6000	6333	6667
			mc/h	0	200	250	300	320	340	360	380	400
FB12SH/1N + 8F35	35	26	H(m)	36	27	24	21	19	17	14	12	9
FB12SH/1L + 8F40	40	30		40	29	27	24	22	20	18	16	12
FB12SH/1D + 8F50	50	37		48	36	34	32	30	29	27	25	22
FB12SH/1A + 8F60	60	45		49	38	36	34	32	31	29	27	25
FB12SH/2L + 8F70	70	51		81	59	55	48	44	40	36	32	24
FB12SH/2G + 8F80	80	59		86	65	60	54	51	47	42	38	33
FB12SH/2F + 8F85	85	62		92	69	65	59	57	53	49	45	40
FB12SH/3N + 8F90	90	66		112	83	75	66	59	52	45	36	27
FB12SH/3L + 10F100	100	75		123	90	82	71	67	62	56	50	42
FB12SH/3G + 10F125	125	92		132	99	92	83	78	72	65	58	50
FB12SH/3D + 10F150	150	110		147	113	106	99	94	89	84	77	69
FB12SH/4F + 10F180*	180	132		188	141	132	121	115	108	101	92	82
FB12SH/5G + 10F200*	200	150		220	164	153	138	130	120	109	97	83
FB12SH/5F + 10F230*	230	170		235	177	165	152	144	135	126	115	102
FB12SH/6F + 10F260*	260	190		282	212	198	182	173	162	151	138	122

Dimensioni e pesi

Overall dimensions and weights - Dimensions d'encombrement et poids

Tipo Type Type	Cv Hp	Kw	A (mm)	B (mm)	C (mm)	D (mm)	ø max (mm)	DN	Peso - Weight - Poids		
									A (kg)	B (kg)	C (kg)
FB12SH/1N + 8F35	35	26	1930	881	1049	192	290	175	251	115	136
FB12SH/1L + 8F40	40	30	1930	881	1049				253	115	138
FB12SH/1D + 8F50	50	37	2000	881	1119				268	115	153
FB12SH/1A + 8F60	60	45	2110	881	1229				286	115	171
FB12SH/2L + 8F70	70	51	2290	1061	1229				314	142	172
FB12SH/2G + 8F80	80	59	2410	1061	1349				326	142	184
FB12SH/2F + 8F85	85	62	2410	1061	1349				326	142	184
FB12SH/3N + 8F90	90	66	2660	1241	1419				374	169	205
FB12SH/3L + 10F100	100	75	2679	1241	1438				479	174	305
FB12SH/3G + 10F125	125	92	2809	1241	1568				522	174	348
FB12SH/3D + 10F150	150	110	2949	1241	1708				568	174	394
FB12SH/4F + 10F180*	180	132	3229	1421	1808				622	201	421
FB12SH/5G + 10F200*	200	150	3529	1601	1928				678	228	450
FB12SH/5F + 10F230*	230	170	3629	1601	2028				718	228	490
FB12SH/6F + 10F260*	260	190	3909	1781	2128				785	255	530

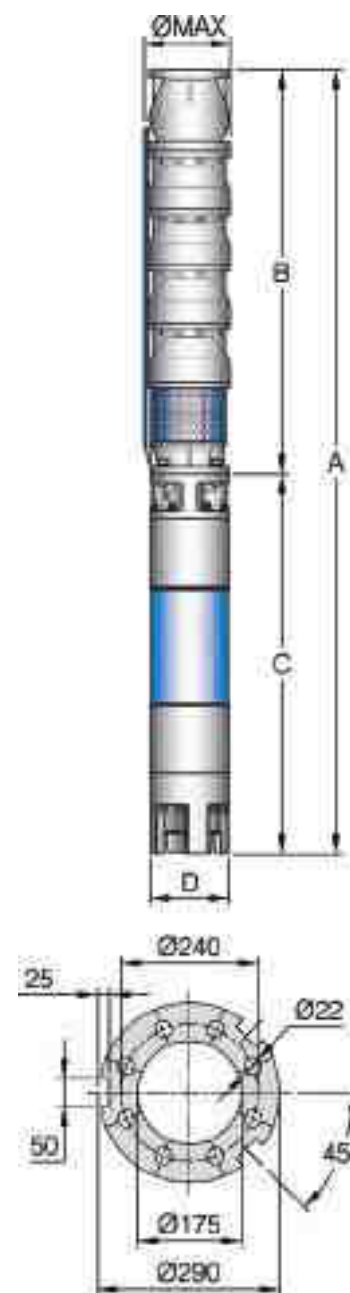

* Non consigliata per montaggio in posizione orizzontale

* This electropump isn't recommended for horizontal assemblage

* Cette électropompe n'est pas recommandée pour le montage en position horizontale

CURVE DELLE PRESTAZIONI

PERFORMANCES' CURVES

COURBES DES PERFORMANCES

FB12SH



n=2900 1/min 50 Hz

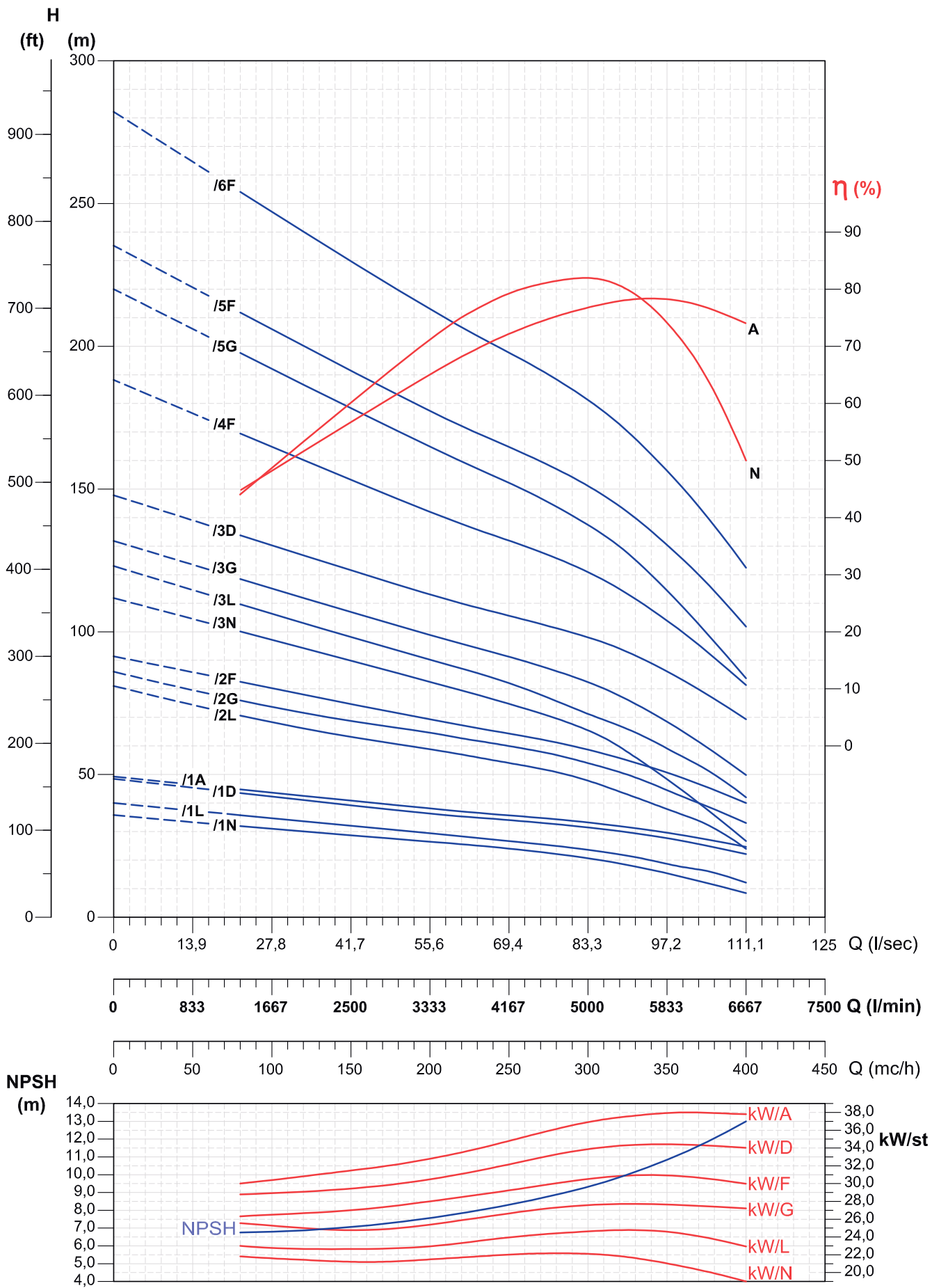

Tolleranze secondo EN ISO 9906 app.A Gr.2 - Tolerances according to EN ISO 9906 anx.A Gr.2 - Tolérances conformes EN ISO 9906 ann.A Gr.2

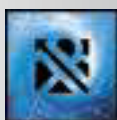

Tipo Type Type	Motore Motors 2900 g/m Moteurs		Q = Portata - Capacity - Débit										
	Cv Hp	Kw	l/sec	0	83,3	94,5	100	105,6	111,1	122,2	133,3	141,7	
			l/min	0	5000	5667	6000	6333	6667	7333	8000	8500	
			mc/h	0	300	340	360	380	400	440	480	510	
FB12SL/1L + 8F50	50	37	H(m)	40	28	26	25	23	22	17	13		
FB12SL/1F + 8F60	60	45		47	33	32	31	30	29	26	21	16	
FB12SL/1A + 8F75	75	55		49	37	36	36	35	33	30	26	22	
FB12SL/2N + 8F85	85	62		74	51	47	45	42	39	30	19		
FB12SL/2L + 8F90	90	66		81	57	53	50	47	44	35	26		
FB12SL/2G + 10F100	100	75		88	62	58	55	53	51	44	35	30	
FB12SL/2D + 10F125	125	92		97	71	68	66	64	62	56	48	40	
FB12SL/3G + 10F150	150	110		134	95	89	85	81	78	67	54	43	
FB12SL/3F + 10F180*	180	132		145	102	99	96	93	88	79	65	51	
FB12SL/3D + 10F200*	200	150		149	109	104	101	98	95	87	73	60	
FB12SL/4F + 10F230*	230	170		193	136	132	128	124	118	106	86	68	
FB12SL/5G + 10F260*	260	190		224	158	148	141	135	130	112	90		

Dimensioni e pesi

Overall dimensions and weights - Dimensions d'encombrement et poids

Tipo Type Type	Cv Hp	Kw	A (mm)	B (mm)	C (mm)	D (mm)	ø max (mm)	DN	Peso - Weight - Poids		
									A (kg)	B (kg)	C (kg)
FB12SL/1L + 8F50	50	37	2000	881	1119	192	290	175	268	115	153
FB12SL/1F + 8F60	60	45	2110	881	1229				286	115	171
FB12SL/1A + 8F75	75	55	2230	881	1349				299	115	184
FB12SL/2N + 8F85	85	62	2410	1061	1349				326	142	184
FB12SL/2L + 8F90	90	66	2480	1061	1419				347	142	205
FB12SL/2G + 10F100	100	75	2499	1061	1438				452	147	305
FB12SL/2D + 10F125	125	92	2629	1061	1568	240	290	175	495	147	348
FB12SL/3G + 10F150	150	110	2949	1241	1708				568	174	394
FB12SL/3F + 10F180*	180	132	3049	1241	1808				595	174	421
FB12SL/3D + 10F200*	200	150	3169	1241	1928				624	174	450
FB12SL/4F + 10F230*	230	170	3629	1601	2028				691	201	490
FB12SL/5G + 10F260*	260	190	3909	1781	2128	758	228	530			

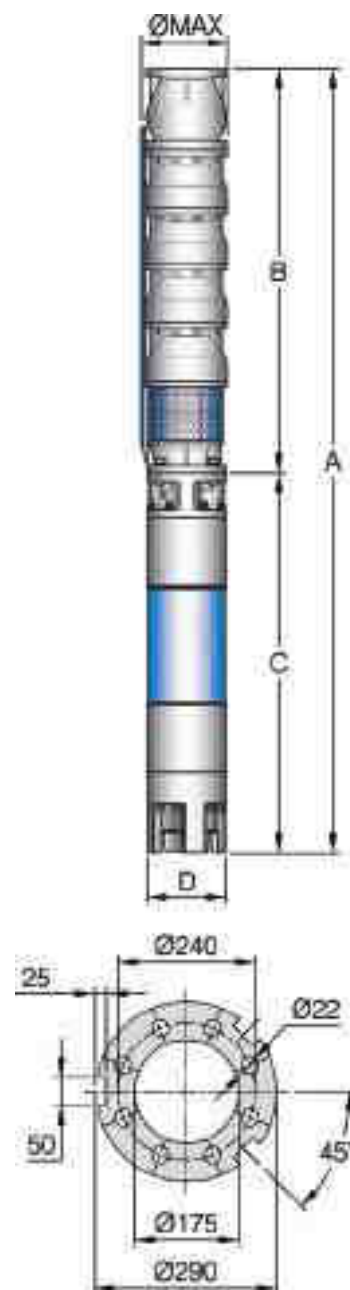

* Non consigliata per montaggio in posizione orizzontale

* This electropump isn't recommended for horizontal assemblage

* Cette électropompe n'est pas recommandée pour le montage en position horizontale

CURVE DELLE PRESTAZIONI

PERFORMANCES' CURVES

COURBES DES PERFORMANCES

FB12SL

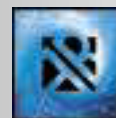

n=2900 1/min 50 Hz

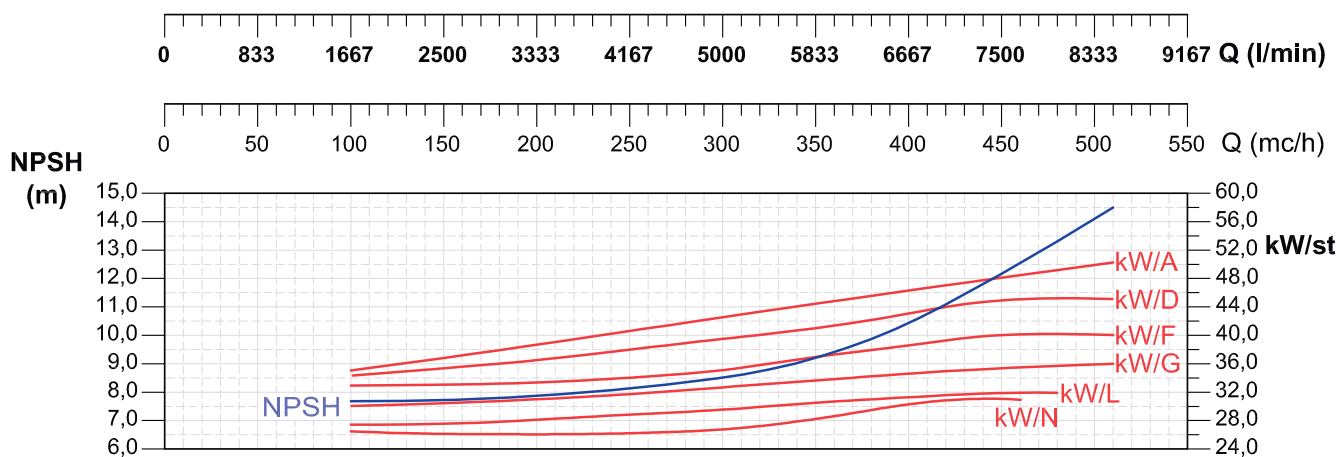
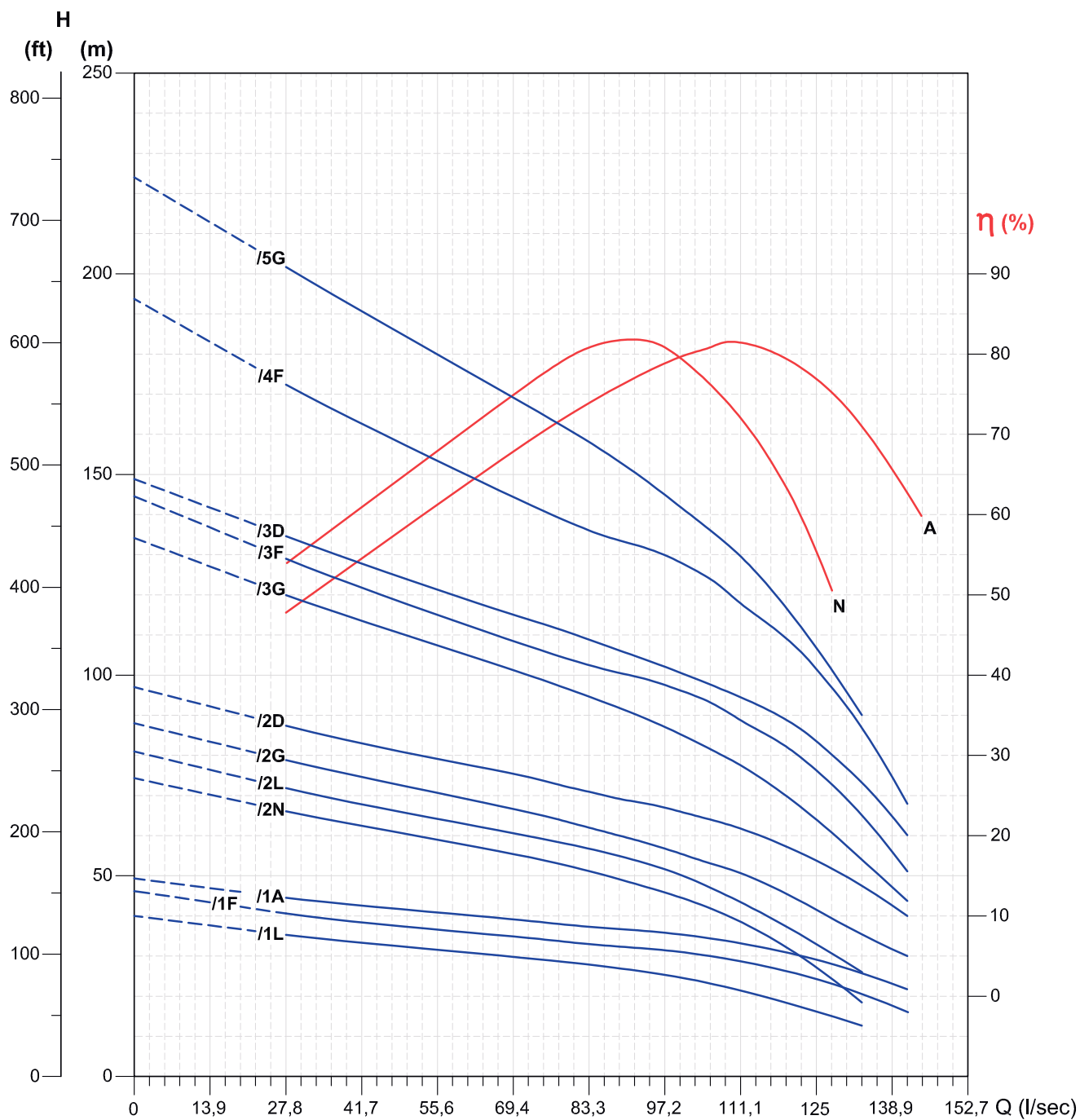

Tolleranze secondo EN ISO 9906 app.A Gr.2 - Tolerances according to EN ISO 9906 anx.A Gr.2 - Tolérances conformes EN ISO 9906 ann.A Gr.2

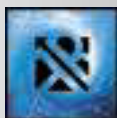

ELETTROPOMPE SOMMERSE 5"

5" SUBMERSIBLE ELECTROPUMPS

ÉLECTROPOMPES IMMERGÉES 5"



Le elettropompe sommerse 5" serie DELFI sono adatte per il prelievo d'acqua da serbatoi, da vasche di raccolta, da corsi d'acqua, da pozzi 6" o di dimensioni maggiori.

Grazie all'immediatezza e alla semplicità dell'installazione, le elettropompe DELFI trovano grande impiego nell'uso civile dove sia necessario l'approvvigionamento idrico qualsiasi sia l'utilizzo, in particolare modo nell'irrigazione.

CONSTRUZIONE:

- supporto superiore e bocca di mandata in acciaio inox AISI 304
- camicia esterna in acciaio inox AISI 304
- albero in acciaio inox AISI 304
- giranti e diffusori in tecnopolimero
- supporti dei cuscinetti in alluminio pressofuso
- doppia tenuta meccanica con camera intermedia ad olio
- condensatore interno in classe B per lunga durata (solo versione monofase)
- motore asincrono 2 poli raffreddato per mezzo del liquido in movimento
- per pompe monofase: versione con o senza galleggiante. È possibile rimuovere il galleggiante e chiudere il foro con l'apposito tappo oppure si può togliere il tappo ed introdurre lo spinotto del galleggiante
- la pompa standard viene fornita con 10 metri di cavo, spinotto di connessione e spina schuko
- tutti i cavi forniti sono in neoprene H07RN-F

CARATTERISTICHE:

- portata massima: 140 l/m
- prevalenza massima: 106 m
- profondità di installazione sotto il livello dell'acqua: 50 metri
- potenza massima: 1,5 Kw
- ingombro massimo: 124 mm
- tolleranza di alimentazione: +6% / -10% V
- max avviamenti orari: 40
- temperatura dell'acqua: fino a 40°C
- contenuto di sabbia massimo: 50 g/m³
- grado di protezione: IP68
- classe di isolamento: F

OPTIONAL:

- su richiesta si possono fornire cavi di lunghezze maggiori (20 o 40 metri)
- su richiesta si possono fornire cavi di tipo EPR per uso alimentare ed omologato KTW, WRAS e ACS
- tensioni e frequenze diverse
- su richiesta si possono fornire elettropompe monofase con condensatore esterno



5" submersible electropumps, range DELFI, are suitable for water taking from reservoirs, collecting tanks, waterways, 6" wells or greater dimensions.

Thanks to the immediacy and the great simplicity of the installation, DELFI electropumps are very common in domestic use, where water supply system is needed, for any kind of employment, in particular for irrigation and gardening.

CONSTRUCTION:

- stainless steel AISI 304 upper support and delivery bowl
- stainless steel AISI 304 external sleeve
- stainless steel AISI 304 shaft
- technopolymer impellers and diffusers
- dye-casted aluminum bearing supports
- double mechanical seal with intermediate lubrication chamber
- internal capacitor in B class for long-lasting (only single-phase versions)
- asynchronous 2 poles motor cooled by the moved liquid
- for single-phase pumps version with or without float. It is possible to remove the float and close the hole with the specific

top or it is possible to take the cap out and insert the plug of the float

- the standard pump is provided with 10 meters cable, connection's plug and schuko plug
- all the cables provided are in neoprene H07RN-F type

CHARACTERISTICS:

- maximum capacity: 140 l/m
- maximum head: 106 m
- installation under the water level: 50 m
- maximum power: 1,5 Kw
- maximum diameter: 124 mm
- supply tolerances: +6/-10 %V
- maximum starts/hour: 40
- water temperature: up to 40°C
- maximum sand content: 50 g/m³
- index protection: IP68
- insulation class: F

OPTIONALS:

- on demand different length of the cables can be provided (20 or 40 meters)
- on demand cables for foodstuff use EPR type or approved by KTW, WRAS and ACS can be provided
- tensions / various frequencies
- on demand single-phase electropumps with external capacitor can be provided



Les électropompes immergées 5" de la série DELFI sont indiquées pour le prélèvement d'eau de réservoirs, de bassins de recueil, de cours d'eau, de puits 6" ou de dimensions majeures.

Grâce à l'instantanéité et à la simplicité de l'installation, les électropompes DELFI trouvent grand emploi civil où soit nécessaire l'approvisionnement hydrique n'importe quel soit l'utilise, particulièrement dans l'irrigation.

CONSTRUCTION:

- support supérieure et orifice de refoulement en acier inoxydable AISI 304
- chemise extérieure en acier inoxydable AISI 304
- arbre en acier inoxydable AISI 304
- roues et diffuseurs en technopolymère
- support de refoulement en aluminium micro-fondu
- double garniture mécanique avec cloche intermédiaire à huile
- condensateur intérieur en classe B pour longue durée (seul version monophasé)
- moteur asynchrone 2 pôles refroidi par le liquide en mouvement
- pour pompes monophasé: version avec ou sans flotteur. Il est possible supprimer le flotteur et fermer le trou avec le bouchon ou il est possible enlever le bouchon et introduire la fiche du flotteur
- la pompe en version standard est livrée avec 10 mètres de câble, fiche de connexion et fiche schuko
- tous les câbles fournis sont en néoprène H07RN-F

CHARACTERISTICS:

- débit maximum: 140 l/m
- hauteur maximale: 106 m
- installation sous le niveau de l'eau: 50 m
- puissance maximale: 1,5 Kw
- encombrement maximum: 124 mm
- tolérance de tension: +6% / -10% V
- maximum démarrages/heure: 40
- température maximale de l'eau: 40°C
- quantité maximale de sable: 50 g/m³
- type de protection: IP 68
- classe d'isolement: F

OPTIONALS:

- sur demande on peut fournir câbles avec différents longueurs (20 ou 40 mètres)
- sur demande on peut fournir câbles du type EPR pour usage alimentaire et homologué KTW, WRAS et ACS
- tensions / fréquences différents
- sur demande on peut fournir pompes monophasé avec condensateur externe



SPACCATO 5"

5" CUTAWAY
COUPE 5"

DELFI

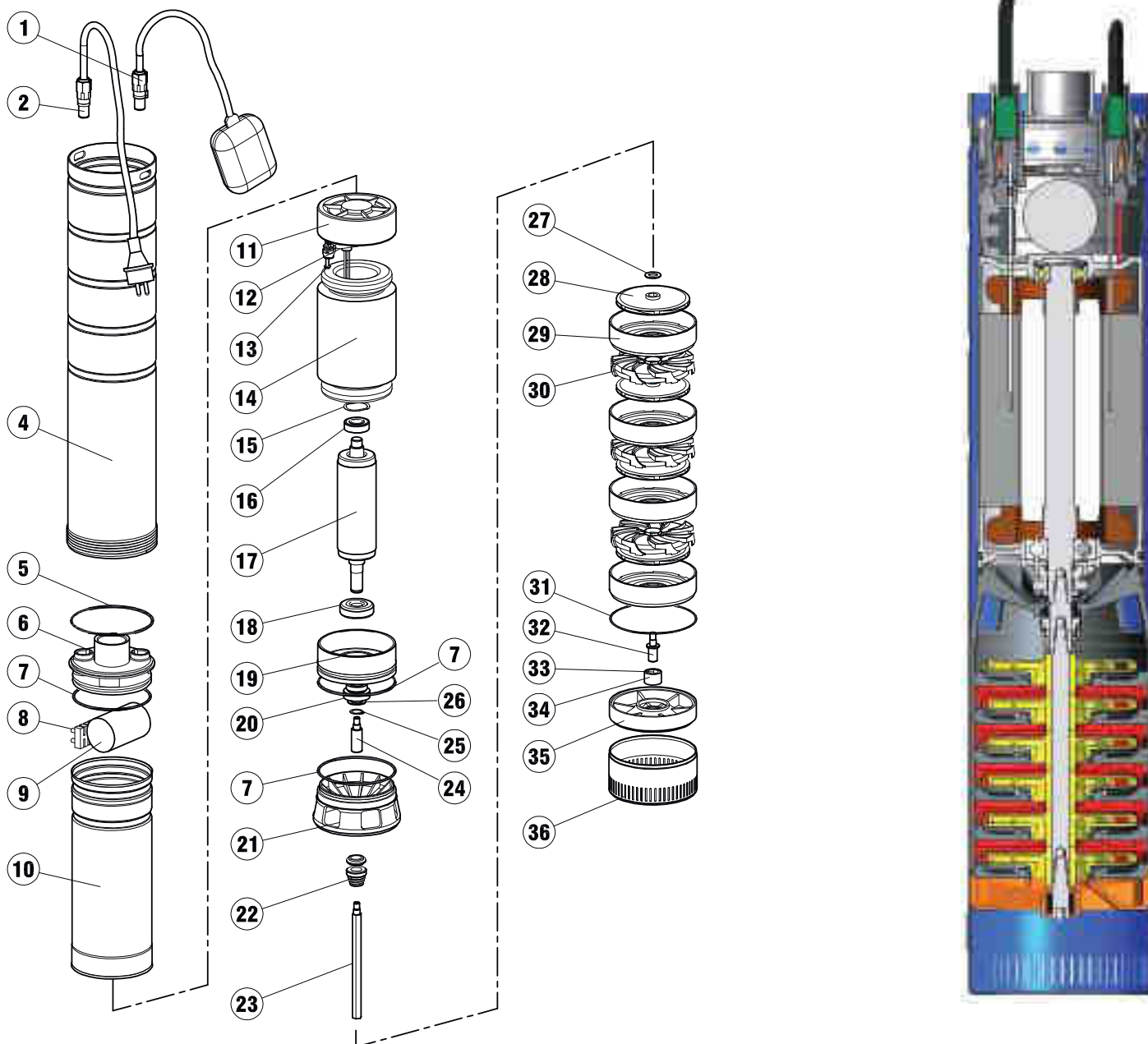
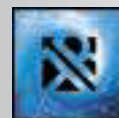

Pos.	Qt.	Denominazione	Denomination	Denomination
1	1	Galleggiante	Float	Flotteur
2	1	Cavo	Cable	Câble
4	1	Camicia	Sleeve	Enveloppe extérieure
5	1	Anello di tenuta	O-ring	Bague de tenue
6	1	Supporto superiore	Upper support	Support supérieur
7	3	Anello di tenuta	O-ring	Bague de tenue
8	1	Morsettiera	Terminal board	Serre-câble
9	1	Condensatore	Capacitor	Condensateur
10	1	Tubo	Tube	Tube
11	1	Flangia superiore	Upper flange	Bride supérieure
12	2	Male plug -3 pin-	Male plug -3 pin-	Male plug -3 pin-
13	4	Vite	Screw	Vis
14	1	Statore	Stator	Stator
15	1	Anello	Ring	Bague
16	1	Cuscinetto 6202-2Z	Bearing 6202-2z	Bague 6202-2Z
17	1	Rotore	Rotor	Rotor
18	1	Cuscinetto 6303-2Z	Bearing 6303-2z	Bague 6303-2Z
19	1	Flangia inferiore	Lower flange	Bride inférieure

Pos.	Qt.	Denominazione	Denomination	Denomination
20	1	Tenuta meccanica	Mechanical seal	Garniture mécanique
21	1	Supporto inferiore	Lower support	Support inférieur
22	1	Tenuta meccanica	Mechanical seal	Garniture mécanique
23	1	Albero esagonale	Hexagonal shaft	Arbre hexagonal
24	1	Perno	Pin	Tourillon
25	1	Anello elastico	Seeger ring	Joint élastique
26	1	Rondella	Washer	Rondelle
27	1	Rondella	Washer	Rondelle
28	*N	Girante	Impeller	Roue
29	*N	Scatola	Box	Enveloppe
30	*N-1	Diffusore	Diffuser	Diffuseur
31	1	Anello di tenuta	O-ring	Bague de tenue
32	1	Perno	Pin	Tourillon
33	1	Esagono in gomma	Rubber hexagonal	Hexagone en caoutch.
34	1	Boccola	Bushing	Entretoise
35	1	Flangia	Flange	Bride
36	1	Filtro	Filter	Filtre

*N=Numero di scatole e giranti variabili dal tipo di pompa

*N=The number of the boxer and the impellers vary according to the type of the pump.

*N=Numéro d'enveloppes et roues selon le type de pompe.

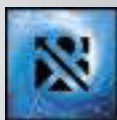

Tipo Type Type		Motore Motors Moteurs 2900 g/m		Q = Portata - Capacity - Débit								
Monofase Single-Phase Monophasé V.230	Trifase Three-Phase Triphasé V.400	Cv Hp	Kw	l/sec	0	0,3	0,7	1	1,3	1,7	2	2,3
				l/min	0	20	40	60	80	100	120	140
		mc/h	0	1,2	2,4	3,6	4,8	6	7,2	8,4		
DELFI 3 - 60M	DELFI 3 - 60	0,6	0,45	H(m)	35,5	30	23,5	14,4	5,3	---	---	---
DELFI 3 - 80M	DELFI 3 - 80	0,8	0,6		47,3	40	31,7	19,5	6,9	---	---	---
DELFI 3 - 100M	DELFI 3 - 100	1	0,75		59,1	50,1	39	24,2	8,2	---	---	---
DELFI 3 - 120M	DELFI 3 - 120	1,2	0,9		70,9	59,7	47	29,4	9,4	---	---	---
DELFI 3 - 150M	DELFI 3 - 150	1,5	1,1		82,7	70	55,7	34,0	10,9	---	---	---
DELFI 3 - 200M	DELFI 3 - 200	2	1,5		106,3	90	69,8	43,4	13,3	---	---	---
DELFI 5 - 80M	DELFI 5 - 80	0,8	0,6		38,7	35,9	32,9	29,2	24,6	19,1	13,9	8,2
DELFI 5 - 120M	DELFI 5 - 120	1,2	0,9		51,8	47,8	43,9	38,8	32,8	26	18,9	11,2
DELFI 5 - 150M	DELFI 5 - 150	1,5	1,1		64,5	59,8	54,8	49,3	40,9	32,2	23,3	13,8
DELFI 5 - 200M	DELFI 5 - 200	2	1,5		77,4	71,8	65,7	58	49	38,9	28	16,3

Specifiche Tecniche

Technical Features - Caractéristiques Techniques

Tipo Type Type	Cv Hp	Kw	Tensione Voltage Voltage	Max corrente assorbita (A) Max absorbed current - Max courant absorbé		μF / 450 V Condensatore Capacitor Condenser	ø max	DN	L mm	Peso Weight Poids (kg)					
				V. 230	V. 400										
DELFI 3 - 60M	0,6	0,45	Monofase Single-phase Monophasé	V. 230	3,7	---	16	124 mm	G 1"1/4	439	10,4				
DELFI 3 - 80M	0,8	0,6			4	---	25			495	12,8				
DELFI 3 - 100M	1	0,75			5,7	---	25			521	13,2				
DELFI 3 - 120M	1,2	0,9			6,5	---	35			590	15,2				
DELFI 3 - 150M	1,5	1,1			7,6	---	35			616	15,6				
DELFI 3 - 200M	2	1,5			9,8	---	40			698	18,2				
DELFI 5 - 80M	0,8	0,6			4,2	---	25			469	12,6				
DELFI 5 - 120M	1,2	0,9			6,4	---	35			515	14,4				
DELFI 5 - 150M	1,5	1,1			8	---	35			541	14,6				
DELFI 5 - 200M	2	1,5			9,15	---	40			620	17,1				
DELFI 3 - 60	0,6	0,45			Trifase Three-phase Triphasé	V. 400	2,5			1,4	---	124 mm	G 1"1/4	439	10,4
DELFI 3 - 80	0,8	0,6					3,3			1,9	---			495	12,8
DELFI 3 - 100	1	0,75	3,9	2,2			---	521	13,2						
DELFI 3 - 120	1,2	0,9	4,5	2,6			---	590	15,2						
DELFI 3 - 150	1,5	1,1	5,1	2,9			---	616	15,6						
DELFI 3 - 200	2	1,5	6,1	3,5			---	698	18,2						
DELFI 5 - 80	0,8	0,6	3,7	2,1			---	469	12,6						
DELFI 5 - 120	1,2	0,9	4,4	2,5			---	515	14,4						
DELFI 5 - 150	1,5	1,1	5,2	3			---	541	14,6						
DELFI 5 - 200	2	1,5	5,9	3,4			---	620	17,1						



CURVE DELLE PRESTAZIONI

PERFORMANCES' CURVES

COURBES DES PERFORMANCES

DELFI



n=2900 1/min 50 Hz

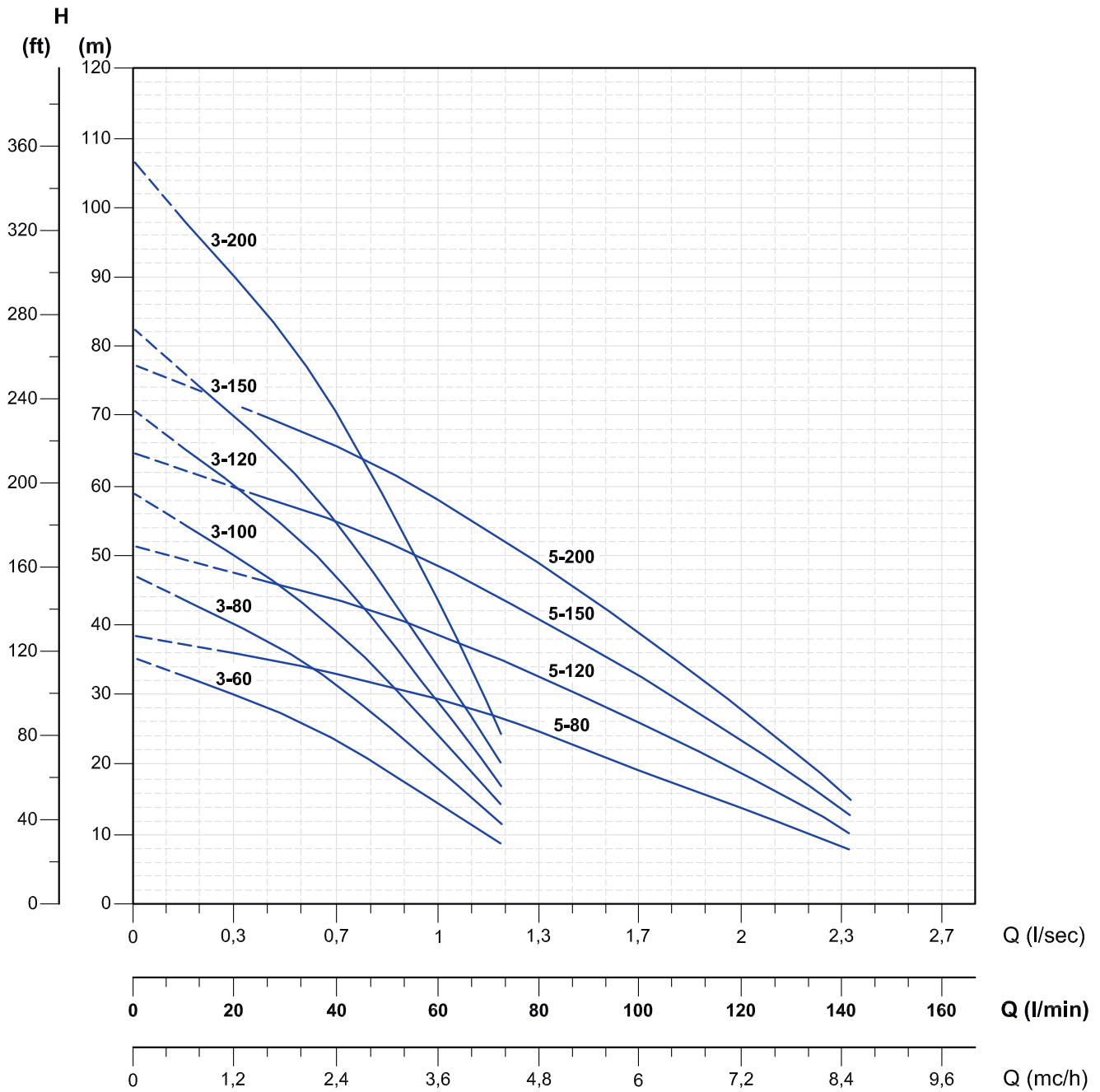

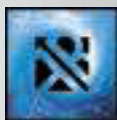
**IC**

QUADRO AVVIATORE MONOFASE CON CONDENSATORE

SINGLE-PHASE CONTROL PANEL WITH CAPACITOR

COFFRET ÉLECTRIQUE DÉMARREUR MONOPHASÉ AVEC CONDENSATEUR



I quadri della serie IC sono sviluppati per il comando di un'elettropompa monofase con protezione termica e condensatore di avviamento.

CARATTERISTICHE:

- ingresso rete 1 ~ 50/60Hz 230V ±10%
- interruttore generale bipolare luminoso 0 - 1
- condensatore di marcia
- un ingresso predisposto per il controllo con galleggiante o pressostato
- protezione termica di sovraccarico ripristinabile esternamente
- involucro termoplastico
- uscite con pressacavi antistrappo
- grado di protezione IP54
- fissaggio a parete mediante fori sfondabili
- temperatura ambiente: -5/+40°C
- umidità relativa a 40°C: 50% (non condensata)



The control panels range IC are developed to control one single-phase electropump with thermal protection and starting capacitor.

FEATURES:

- input voltage 1 ~ 50/60Hz 230V ±10%
- luminous main switch 0 - 1
- running capacitor
- an input for a float switch or a pressure switch
- thermal protection with external reset button
- thermoplastic box
- outlets with cable-holders
- protection grade IP54
- arrangement for wall mounting
- ambient temperature: -5/+40°C
- relative humidity at 40°C: 50% (condensate free)



Les coffrets de la série IC son développés pour le contrôle d'une électropompe monophasé avec protection thermique et condensateur de démarrage.

CARACTÉRISTIQUES:

- alimentation 1 ~ 50/60Hz 230V ±10%
- interrupteur lumineux 0 - 1
- condensateur de marche
- une entrée pour le flotteur ou le pressostat
- protection thermique de surcharge à rétablissement extérieur
- armoire thermoplastique
- sorties avec passe-câbles
- grade de protection IP54
- fixation mural
- température du ambiant: -5/+40°C
- humidité relative a 40°C: 50% (non condensé)

Tipo Type Type	Condensatore Capacitor Condensateur	Grado di protezione Index Protection Grade de protection	Potenza Power - Puissance		Corrente Max Max Current Courant Max	Dimensioni e Pesì Dimensions and Weight Dimensions et Poids			
			Cv Hp	Kw		A (mm)	B (mm)	P(mm)	KG
IC - 0,5	20 µF	IP 54	0,5	0,37	4	160	160	70	0,5
IC - 0,75	25 µF		0,75	0,55	6	160	160	70	0,5
IC - 1	35 µF		1	0,75	8	160	160	70	0,5
IC - 1,5	40 µF		1,5	1,1	10	160	160	70	0,5
IC - 2	55 µF		2	1,5	14	160	160	70	0,5
IC - 3	75 µF		3	2,2	18	160	160	70	0,5

QUADRO AVVIATORE MONOFASE AD ALTA COPPIA DI AVVIAMENTO

SINGLE-PHASE HIGH STARTING TORQUE CONTROL PANEL

COFFRET ÉLECTRIQUE MONOPHASÉ À HAUTE COUPLE DE DÉMARRAGE

IC DUAL

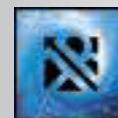

I quadri della serie IC-DUAL sono progettati per il comando di un'elettropompa sommersa monofase con l'inserimento di un doppio condensatore, al fine di garantire un'alta coppia di spunto. All'avviamento, dopo il raggiungimento di una certa tensione ai capi del secondo condensatore, il Relais voltmetrico disinserisce il condensatore elettrolitico.

L'utilizzo di questo quadro è da preferire quando:

- il cavo di alimentazione è particolarmente lungo
- l'acqua pompata presenta un grado di durezza elevato (formazione di calcare)
- si riscontra elevata concentrazione di sabbia nell'acqua
- l'elettropompa non viene utilizzata per lunghi periodi

CARATTERISTICHE:

- ingresso rete 1 ~ 50/60Hz 230V ±10%
- interruttore generale bipolare luminoso 0 - 1
- condensatore di marcia
- condensatore elettrolitico (di avviamento)
- un ingresso predisposto per il controllo con galleggiante o pressostato
- protezione termica di sovraccarico ripristinabile esternamente
- involucro termoplastico
- uscite con pressacavi antistrappo
- grado di protezione IP54
- fissaggio a parete mediante fori sfondabili
- temperatura ambiente: -5/+40°C
- umidità relativa a 40°C: 50% (non condensata)



IC-DUAL control panels are studied to control a single-phase submersible electropump helped by two capacitors, to assure high starting torque. At start-up, when a certain voltage is reached on the second capacitor the voltmetric relay deactivates the electrolytic capacitor.

This control panel is recommended when:

- power supply cable is particularly long
- pumped water has high degree of hardness (limestone)
- water has high content of sand
- the electropump doesn't work for very long time

FEATURES:

- input voltage 1 ~ 50/60Hz 230V ±10%
- luminous main switch 0 - 1
- running capacitor
- electrolytic capacitor (starting)
- an input for a float switch or a pressure switch
- thermal protection with external reset button
- thermoplastic box
- outlets with cable-holders
- protection grade IP54
- arrangement for wall mounting
- ambient temperature: -5/+40°C
- relative humidity at 40°C: 50% (not condensed)



NEW



Les coffrets électroniques type IC-DUAL sont étudiés pour le démarrage d'une électropompe immergée avec deux condensateurs, pour garantir une haute couple de démarrage.

Pendant le démarrage, quand le second condensateur atteint le voltage, le relais voltmetric débranche le condensateur électrolytique.

Ce type de coffret électronique est recommandé quand:

- le câble d'alimentation est très long
- l'eau pompée a un degré de dureté élevé (calcaire)
- il y a beaucoup de sable dans l'eau
- l'électropompe ne marche pas depuis long temps

CARACTÉRISTIQUES:

- alimentation 1 ~ 50/60Hz 230V ±10%
- interrupteur lumineux 0 - 1
- condensateur de marche
- condensateur électrolytique (démarrage)
- une entrée pour le flotteur ou le pressostat
- protection thermique de surcharge à rétablissement extérieur
- armoire thermoplastique
- sorties avec passe-câbles
- grade de protection IP54
- fixation mural
- température du ambient: -5/+40°C
- humidité relative a 40°C: 50% (non condensé)

Tipo Type Type	Condensatore Capacitor Condensateur	Grado di protezione Index Protection Grade de protection	Potenza Power - Puissance		Corrente Max Max Current Courant Max	Dimensioni e Pesì Dimensions and Weight Dimensions et Poids			
			Cv Hp	Kw		A (mm)	B (mm)	P (mm)	KG
IC DUAL - 0,5	20 µf + 36/43	IP 54	0,5	0,37	4	25	20	10	1,4
IC DUAL - 0,75	25 µF + 53/64		0,75	0,55	6	25	20	10	1,4
IC DUAL - 1	35 µF + 88/106		1	0,75	8	25	20	10	1,4
IC DUAL - 1,5	40 µF + 100/125		1,5	1,1	10	25	20	10	1,4
IC DUAL - 2	55 µF + 125/160		2	1,5	14	25	20	10	1,4
IC DUAL - 3	75 µF + 200/250		3	2,2	18	25	20	10	1,5
IC DUAL - 5	90 µF + 250/300		5	3,7	30	31	25	13	2,4
IC DUAL - 5,5	120 µF + 315/400		5,5	4	35	31	25	13	2,4

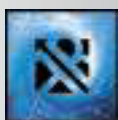

WELL

QUADRO ELETTRONICO MONOFASE O TRIFASE

SINGLE-PHASE OR THREE-PHASE CONTROL PANEL
COFFRET ÉLECTRONIQUE MONOPHASÉ OU TRIPHASÉ



I quadri della serie WELL sono progettati per il comando di un'elettropompa sommersa da pozzo, sommergibile da drenaggio o di superficie.

Con la loro semplicità forniscono una completa protezione della vostra elettropompa.

CARATTERISTICHE:

- Alimentazione monofase 100-240Vac 50/60Hz
- Alimentazione trifase 310-450Vac 50/60Hz
- Controllo di livello per sonde di riempimento o svuotamento
- Controllo sequenza/mancanza fase con segnalazione luminosa
- Controllo temperatura per clicson elettropompa
- Controllo elettronico massima corrente per sovraccarico
- Controllo elettronico minima corrente per marcia a secco
- Ripristino automatico per allarme minima corrente
- Ingresso galleggianti o pressostati
- Ingresso galleggiante attivazione allarme
- Predisposizione per condensatore di marcia (non incluso) per versione monofase
- Pulsanti automatico -0- manuale (instabile)
- Selettori DIP SWITCH per:
 - Abilitazione allarme livello da sonde
 - Ritardo intervento termico
 - Impostazione uscite allarmi
 - Abilitazione reset allarme da clicson motore
 - Funzionamento riempimento/svuotamento
 - Abilitazione galleggianti marcia/arresto
 - Abilitazione ritardo attivazione elettropompa da rientro rete elettrica da 0 a 15 secondi
- Led verdi: elettropompa ON, presenza rete – automatico inserito
- Led rossi: allarme livello da sonde, allarme livello da galleggiante, allarme sovraccarico, allarme clicson elettropompa, allarme minima corrente
- Uscita allarme accumulativa in tensione 12V (100 mA)
- Fusibile di protezione ausiliari e di potenza
- Box in ABS, IP 55
- Temperatura ambiente -5 / + 40°C
- Umidità relativa 50% a 40°C (non condensata)



NEW

QUADRO ELETTRONICO MONOFASE O TRIFASE

SINGLE-PHASE OR THREE-PHASE CONTROL PANEL

COFFRET ÉLECTRONIQUE MONOPHASÉ OU TRIPHASÉ

WELL

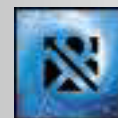

WELL control panels are studied for the control of submersible electropumps, sewage pumps and surface pumps. As they are very easy in the installation, they grant to the electropump complete protection.

FEATURES:

- Single phase power supply 100-240Vac 50/60Hz
- Three phase power supply 310-450Vac 50/60Hz
- Level control for filling or emptying probes
- Light-signalling for sequence/failure phase
- Temperature control for electropump clicson
- Electronic control of maximum current due to overload
- Electronic control of minimum current due to dry run
- Automatic reset due to minimum current alarm
- Float switch or pressure switch input
- Alarm activation for float switch input
- Provision for start-up capacitors, single phase version (not included)
- Automatic -0- manual buttons (spring return)
- DIP-SWITCH selectors for:
 - Level alarm enable from sensors,
 - Thermal cut-out activation delay 5/10 seconds,
 - Alarm output settings,
 - Alarm reset enable from motor clicson,
 - Filling/Emptying mode,
 - Start/stop float enable,
 - Delay enable on the activation of the electropump on power mains return from 0 to 15 seconds
- Green led: electropump ON, power ON - automatic mode enabled
- Red led: probes level alarm, float switch level alarm; overload alarm, electropump clicson alarm, minimum current alarm
- Cumulative alarm output, live (12Vcc / 100mA)
- Protections of auxiliary circuits and motor with fuses
- Box in ABS, IP 55
- Ambient temperature: -5/+40 °C;
- Relative humidity 50% at 40 °C (condensate free).



Les coffrets électroniques de la série WELL sont conçus pour le contrôle d'une électropompe immergée, pompes submersibles et pompes de surface. Puisqu'ils sont très simples à utiliser ils garantissent complète protection à l'électropompe.

CARACTÉRISTIQUES:

- Alimentation monophasé 100-240Vac 50/60Hz
- Alimentation triphasé 310-450Vac 50/60Hz
- Control de niveau pour sondes de remplissage ou vidage
- Control séquence/manque phase avec signal lumineux
- Control température pour clicson électropompe
- Control électronique courant maximale pour surcharge
- Control électronique courant minimale contre la marche à sec
- Réinitialisation automatique pour alarme courant minimale
- Entrée flotteur ou pressostat
- Entrée flotteur activation d'alarme
- Addition de condensateur de démarrage possible (pas inclus)
- Bouton automatique -0- manuel (instable)
- Sélecteur DIP SWITCH pour:
 - Habilitation alarme niveau sondes
 - Délai d'intervention thermique
 - Sortie alarme
 - Habilitation reset alarme clicson moteur
 - Fonctionnement remplissage / vidage
 - Habilitation flotteur de marche/arrêt
 - Habilitation délai activation électropompe par rentrée réseau électrique de 0 à 15 seconds
- Led vert: électropompe ON, présence réseau - fonctionnement automatique
- Led rouge: alarme niveau sondes, alarme niveau flotteur, alarme surcharge, alarme clicson électropompe, alarme courant minimale
- Sortie alarme accumulé en tension 12V (100 mA)
- Fusible de protection auxiliaire et de puissance
- Armoire en ABS, IP55
- Température ambient: -5/+40 °C
- Humidité relative 50% à 40 °C (non condensé).

Tipo Type Type	Tensione Tension Tension	Grado di protezione Index Protection Grade de protection	Potenza Power - Puissance		Corrente Max Max Current (A) Courant Max	Dimensioni e Pesì Dimensions and Weight Dimensions et Poids			
			Cv Hp	Kw		A (mm)	B (mm)	P (mm)	KG
WELL /M	Monofase Single-phase Monophasé	IP 55	0,5 ÷ 3	0,37 ÷ 2,2	18	320	240	190	2,5
WELL 7,5/T	Trifase Three-phase Triphasé		0,5 ÷ 7,5	0,37 ÷ 5,5	16	320	240	190	5,5
WELL 15/T			0,5 ÷ 15	0,37 ÷ 11	32	320	240	190	6,5

Optional:

AAC	Allarme acustico cablato - Wired acoustic alarm - Alarme sonore filaire
AVC	Allarme visivo cablato - Wired visual alarm - Alarme visuelle filaire
BP	Blocco porta - Door lock - Serrure de porte
S-WELL /M	Scheda ricambio quadro WELL /M - Spare boards for control panel WELL /M - Rechange tableau électrique pour WELL /M
S-WELL 7,5/T	Scheda ricambio quadro WELL /M - Spare boards for control panel WELL 7,5/T - Rechange tableau électrique pour WELL 7,5/T
S-WELL 15/T	Scheda ricambio quadro WELL /M - Spare boards for control panel WELL 7,5/T - Rechange tableau électrique pour WELL 15/T

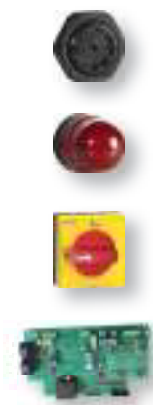

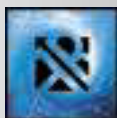

I quadri elettronici della serie SELF-CONTROL sono progettati per l'avviamento di un'elettropompa monofase o trifase. Essi sono idonei per la protezione contro la marcia a secco senza l'utilizzo di sonde di livello e dotati di protezioni.

CARATTERISTICHE:

- ingresso rete 1 ~ 50 Hz 230 V ± 10% (solo monofase)
- ingresso rete 3 ~ 50 Hz 400 V ± 10% (solo trifase)
- display LED 7 seg. visualizzazione corrente assorbita
- predisposizione per condensatore (solo versione monofase)
- ingresso ausiliario galleggiante / pressostato
- impostazione automatica dei parametri o inserimento dati in manuale
- protezione elettropompa contro la marcia a secco mediante controllo $\cos\phi$ e ripristino dopo 10-20-40-80-120 minuti
- protezione elettronica da sovraccarico motore
- protezione per mancanza fase (solo trifase)
- protezione da basse tensioni (-15%) e sovratensioni (+15%)
- grado di protezione IP55
- pressacavi PG21 e PG11



The control panels range SELF-CONTROL are studied for the starting of a single-phase or three-phase electropump. They are suitable for the protection against dry-working without the use of level probes and equipped with protections.

FEATURES:

- input voltage 1 ~ 50 Hz 230 V ± 10% (single-phase only)
- input voltage 3 ~ 50 Hz 400 V ± 10% (three-phase only)
- display LED 7 seg. absorbed current visualization
- internal capacitor (single-phase only)
- auxiliary input float / pressure switch
- automatic setting of the parameters or manual insertion of the data
- protection of the electropump against dry-working by $\cos\phi$ check and resetting after 10-20-40-80-120 minutes
- motor overload electronic protection
- phase failure protection (three-phase only)
- low voltage (-15%) and overvoltage protection (+15%)
- index protection IP55
- cable glands PG21 e PG11



Les coffrets électroniques de la serie SELF-CONTROL sont étudiés pour le démarrage d'une électropompe monophasé ou triphasé. Ils sont aptes à la protection contre le fonctionnement à sec sans l'utilisation de sondes et équipés avec protections.

CARACTÉRISTIQUES:

- alimentation 1 ~ 50 Hz 230 V ± 10% (seul monophasé)
- alimentation 3 ~ 50 Hz 400 V ± 10% (seul triphasé)
- display LED 7 seg. visualisation de la courant absorbée
- condensateur à l'intérieur (seul monophasé)
- entrée auxiliaire flotteur / pressostat
- réglage automatique des paramètres ou insertion manuel des données
- protection de la pompe contre le fonctionnement à sec par le control du $\cos\phi$ et rétablissement après 10-20-40-80-120 minutes
- protection électronique surcharge moteur
- protection manque phase (seul triphasé)
- protection baisse tension (-15%) et surtension (+15%)
- grade de protection IP55
- passe-câbles PG21 e PG11

QUADRO ELETTRONICO CON PROTEZIONE MARCIA A SECCO SENZA SONDE

ELECTRONIC CONTROL PANEL WITH PROTECTION AGAINST DRY WORKING WITHOUT PROBES
 COFFRET ÉLECTRONIQUE AVEC PROTECTION CONTRE LE FONCTIONNEMENT À SEC SANS SONDES

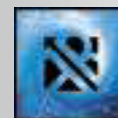

Tipo Type Type	Tensione Tension Tension	Grado di protezione Index Protection Grade de protection	Potenza Power - Puissance		Corrente Max Max Current (A) Courant Max	Dimensioni e Pesì Dimensions and Weight Dimensions et Poids			
			Cv Hp	Kw		A (mm)	B (mm)	P (mm)	KG
SELF-CONTROL / M	Monofase Single-phase Monophasé	IP 55	0,5 ÷ 3	0,37 ÷ 2,2	20	240	190	90	1,8
SELF-CONTROL 4 / T	Trifase Three-phase Triphasé		0,5 ÷ 4	0,37 ÷ 3	10	240	190	90	1,8
SELF-CONTROL 10 / T			5,5 ÷ 10	4 ÷ 7,5	20	240	190	90	1,8
SELF-CONTROL 15 / T			12,5 ÷ 15	9,2 ÷ 11	30	240	190	90	2,4

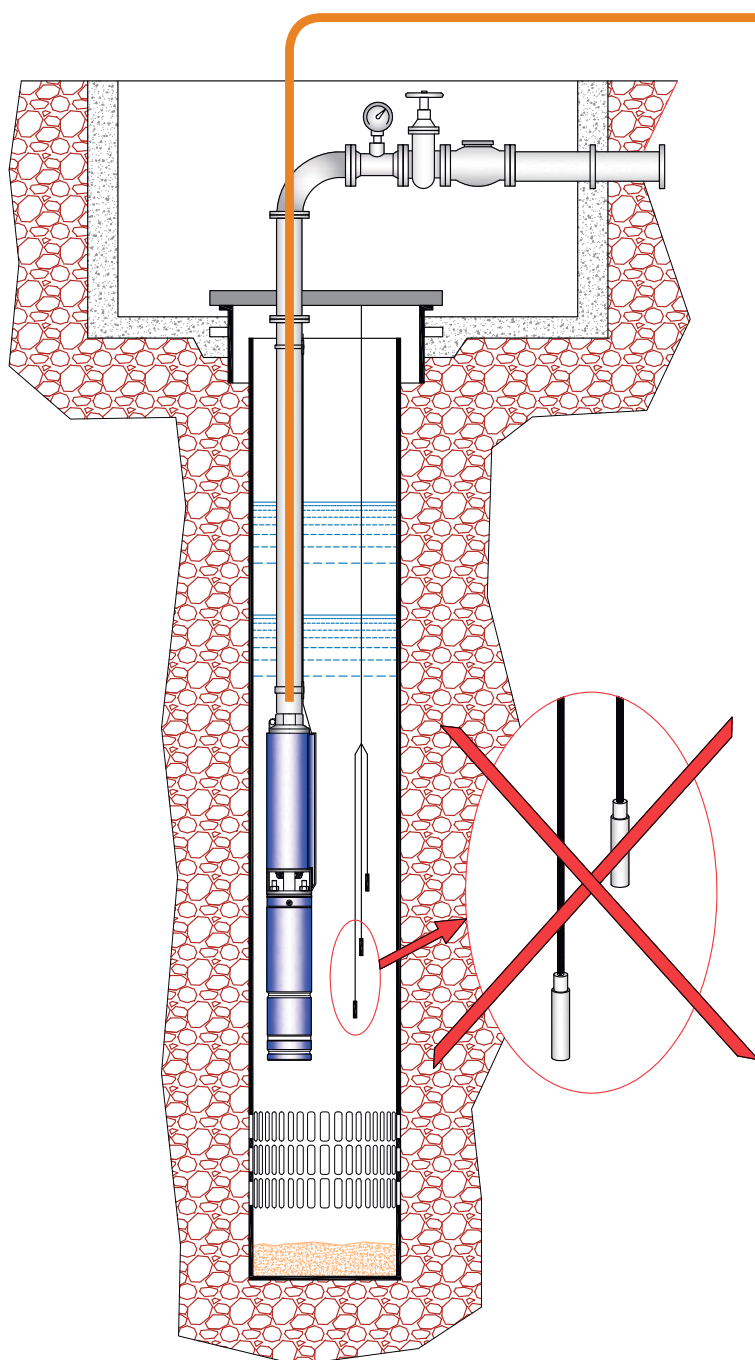

- PROTEGGE SENZA SONDE DI LIVELLO
- IT PROTECTS WITHOUT LEVEL PROBES
- PROTÈGE SANS LES SONDES DE NIVEAU

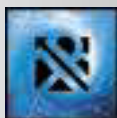

I quadri elettromeccanici della serie BASIC sono per l'avviamento diretto, sviluppati per il comando di una elettropompa monofase o trifase e dotati di protezioni.

CARATTERISTICHE:

- ingresso rete 1 ~ 50/60Hz 230V ±10% (BASIC - M)
- ingresso rete 3 ~ 50/60Hz 400V ±10% (BASIC - T)
- trasformatore 400+230/24V per circuiti ausiliari (solo BASIC - T)
- condensatore interno (solo BASIC - M)
- un ingresso galleggiante / pressostato
- selettore Automatico (stabile) - 0 - Manuale (instabile)
- luce spia verde per pompa in funzione
- luce spia rossa di allarme pompa in protezione
- contattore di linea categoria AC3
- relè termico di sovraccarico ripristinabile internamente
- fusibili di protezione ausiliari e potenza
- involucro in termoplastico (ABS)
- uscite con pressa cavi antistrappo
- grado di protezione IP55
- temperatura ambiente: -5/+40°C
- umidità relativa a 40°C: 50% (non condensata)



The electromechanical control panels range BASIC are for direct starting, developed for the control of a single-phase or three-phase electropump and equipped with protections.

FEATURES:

- input voltage 1 ~ 50/60Hz 230V ±10% (BASIC - M)
- input voltage 3 ~ 50/60Hz 400V ±10% (BASIC - T)
- transformer for auxiliary circuits 400+230/24V (BASIC - T only)
- internal capacitor (BASIC - M only)
- input for a float switch or a pressure switch
- selector Automatic (stable) - 0 - Manual (unstable)
- green led for motor operating
- red led for motor protection alarm
- line contactor AC3 class
- overload thermal relay internally restorable
- auxiliary circuits and motor protection fuses
- enclosure in thermoplastic (ABS)
- outputs with cable-holders
- index Protection IP55
- ambient temperature: -5/+40°C
- relative humidity at 40°C: 50% (condensate free)



Les coffrets électromécaniques de la série BASIC sont conçus pour le contrôle d'une électropompe monophasé ou triphasé et équipés de protections.

CARACTÉRISTIQUES:

- alimentation 1 ~ 50/60Hz 230V ±10% (BASIC - M)
- alimentation 3 ~ 50/60Hz 400V ±10% (BASIC - T)
- transformateur 400+230/24V pour circuits auxiliaires (BASIC - T seulement)
- condensateur interne (BASIC - M)
- entrée pour le flotteur ou le pressostat
- sélecteur Automatique (stable) - 0 - Manuel (instable)
- d.e.l. vert de moteur en fonction
- d.e.l. rouge d'alarme moteur en protection
- contacteur de ligne en classe AC3
- relais thermique de surcharge à rétablissement interne
- fusibles de protection de moteur et des auxiliaires
- armoire en thermoplastique (ABS)
- sorties avec passe-câbles
- grade de protection IP55
- température du ambiant: -5/+40°C
- humidité relative à 40°C: 50% (non condensé)

QUADRO ELETTROMECCANICO MONOFASE O TRIFASE

SINGLE-PHASE OR THREE-PHASE ELECTROMECHANICAL CONTROL PANEL

COFFRET ÉLECTROMÉCANIQUE MONOPHASÉ OU TRIPHASÉ

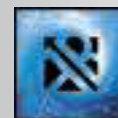

Tipo Type Type	Tensione Tension Tension	Grado di protezione Index Protection Grade de protection	Potenza Power - Puissance		Corrente Max Max Current Courant Max (A)	Dimensioni e Pesì Dimensions and Weight Dimensions et Poids					
			Cv Hp	Kw		A (mm)	B (mm)	P(mm)	KG		
BASIC - 0,5 / M	Monofase Single-phase Monophasé	IP 55	0,5	0,37	3 ÷ 4,5	340	240	170	3,5		
BASIC - 0,75 / M			0,75	0,55	4,5 ÷ 6,5	340	240	170	3,5		
BASIC - 1 / M			1	0,75	6 ÷ 9	340	240	170	3,5		
BASIC - 1,5 / M			1,5	1,1	9 ÷ 13,5	340	240	170	3,5		
BASIC - 2 / M			2	1,5	10 ÷ 16	340	240	170	3,5		
BASIC - 3 / M			3	15 ÷ 20	15 ÷ 20	340	240	170	3,5		
BASIC - 5,5 / M			4 ÷ 5,5	3 ÷ 4	20 ÷ 32	340	240	170	3,5		
BASIC - 1 / T			Trifase Three-phase Triphasé	IP 55	1	0,75	2 ÷ 3,2	340	240	170	3,5
BASIC - 1,5 / T					1,5	1,1	3 ÷ 4,5	340	240	170	3,5
BASIC - 3 / T					3	2,2	6 ÷ 9	340	240	170	3,5
BASIC - 5,5 / T					4 ÷ 5,5	3 ÷ 4	10 ÷ 16	340	240	170	3,5
BASIC - 7,5 / T					7,5	5,5	15 ÷ 20	340	240	170	3,5
BASIC - 10 / T					10	7,5	18 ÷ 22	340	240	170	3,5
BASIC - 15 / T					15	11	20 ÷ 32	340	240	170	3,5

Optional:

RAS/220

Relè automatismo sonda livello per quadro monofase-Automatism level probes relay for single-phase control panel-Réle automatisme sondes de niveau pour coffret électrique monophasé



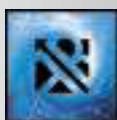

 I quadri elettromeccanici DIR sono per l'avviamento diretto, sviluppati per il comando di un'elettropompa trifase e dotati di protezioni.

CARATTERISTICHE:

- ingresso rete 3 ~ 50/60Hz 400V ± 10%
- trasformatore per circuiti ausiliari 400+230/24V
- selettore Automatico (stabile) - 0 - Manuale (instabile)
- un ingresso galleggiante / pressostato
- luce blu di presenza rete
- luce verde di motore in funzione
- luce rossa di allarme motore in protezione
- contattore di linea di categoria AC3
- relé termico di sovraccarico ripristinabile internamente
- fusibili di protezione ausiliari e potenza
- sezionatore generale con blocco porta
- armadio metallico
- grado di protezione IP55
- temperatura ambiente: -5/+40°C
- umidità relativa a 40°C: 50% (non condensata)



The electromechanical control panels range DIR are developed for the control of one three-phase electropump and equipped with protections.

FEATURES:

- input voltage 3 ~ 50/60Hz 400V ± 10%
- transformer for auxiliary circuits 400+230/24V
- selector for Automatic (stable) - 0 - Manual (unstable)
- input for a float switch or a pressure switch
- blue led for power on
- green led for motor operating
- red led for motor protection alarm
- line contactor AC3 class
- overload thermal relay internally restorable
- auxiliary circuits and motor protection fuses
- main switch with door interlock
- metallic cabinet
- index Protection IP55
- ambient temperature: -5/+40°C
- relative humidity at 40°C: 50% (condensate free)



Les coffrets électromécaniques de la série DIR sont conçues pour le contrôle d'une électropompe triphasé et équipés de protections.

CARACTÉRISTIQUES:

- alimentation 3 ~ 50/60Hz 400V ± 10%
- transformateur pour circuits auxiliaires 400+230/24V
- sélecteur pour Automatique (stable) - 0 - Manuel (instable)
- entrée pour le flotteur ou le pressostat
- d.e.l. bleu de Présence réseau
- d.e.l. vert de moteur en fonction
- d.e.l. rouge d'alarme moteur en protection
- contacteur de ligne en classe AC3
- relais thermique de surcharge à rétablissement manuel
- fusibles de protection moteur et auxiliaires
- sectionneur général avec verrouillage de la porte
- armoire métallique
- grade de protection IP55
- température du ambiant: -5/+40°C
- humidité relative à 40°C: 50% (non condensé)

QUADRO ELETTROMECCANICO AD AVVIAMENTO DIRETTO

DIRECT STARTING ELECTROMECHANICAL CONTROL PANEL

COFFRET ÉLECTROMÉCANIQUE À DÉMARRAGE DIRECT

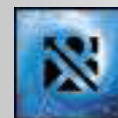

Tipo Type Type	Grado di protezione Index Protection Grade de protection	Potenza Power - Puissance		Corrente Max Max Current Courant Max (A)	Dimensioni e Pesì Dimensions and Weight Dimensions et Poids			
		Cv Hp	Kw		A (mm)	B (mm)	P(mm)	KG
DIR - 1 / 5,5	IP 55	5,5	4	9 ÷ 15	430	300	230	10
DIR - 1 / 7,5		7,5	5,5	13 ÷ 18	430	300	230	10
DIR - 1 / 10		10	7,5	17 ÷ 23	430	300	230	11
DIR - 1 / 12		12,5	9,2	20 ÷ 25	430	300	230	11
DIR - 1 / 15		15	11	24 ÷ 32	430	300	230	11
DIR - 1 / 20		20	15	32 ÷ 38	530	400	230	12
DIR - 1 / 25		25	18,5	35 ÷ 50	530	400	230	12
DIR - 1 / 30		30	22	46 ÷ 65	530	400	230	15
DIR - 1 / 40		40	30	60 ÷ 82	530	400	230	15
DIR - 1 / 50		50	37	70 ÷ 95	630	500	230	15

Optional:

CL/24	Controllo di livello (sonde escluse) - Level control for probes (probes excluded) for dry running protection - Contrôle de niveau pour sondes (sondes exclues) contre la marche à sec
Kit S/L	Kit sonda di livello - Kit level probes - Kit sondes de niveau
V500C	Kit voltmetro 500 Vfz - Voltmeter kit 500 Vfz - Kit voltmètre 500 Vfz
AC	Kit amperometro - Ammeter kit - Kit ampèremètre
CV3F	Commutatore voltmetrico - Voltmeter selector - Sélecteur voltmètre
CA3F	Commutatore amperometrico con 3 T.A. - Ammetric selector with 3 T.A. - Sélecteur ampèremètre avec 3 T.A.
CO-1	Contaore - Hour counter - Compte-heures
ASF400	Controllo sequenza e mancanza fasi - Wired control of sequence and lack of phases - Contrôle de séquence et manque phase
DRV400	Relè controllo di minima e massima tensione - Relay for control of min / max voltage - Relais de contrôle min / max tension



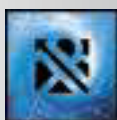

I quadri elettromeccanici della serie STA sono per l'avviamento ad impedenza storica, sviluppati per il comando di un'elettropompa trifase e dotati di protezioni.

CARATTERISTICHE:

- ingresso rete 3 ~ 50/60Hz 400V ± 10%
- trasformatore per circuiti ausiliari 400+230/24V
- selettore Automatico (stabile) – 0 – Manuale (instabile)
- un ingresso galleggiante / pressostato
- luce spia blu di presenza rete
- luce verde di motore in funzione
- luce rossa di allarme motore in protezione
- contattore di linea di categoria AC3
- contattore di avviamento impedenza di categoria AC3
- impedenza di avviamento
- n° 4 manovre/ora di cui max. 2 consecutive
- tempo di accelerazione max. 15 s.
- relè termico di sovraccarico ripristinabile internamente
- temporizzatore di sgancio impedenza 0 ÷ 30 s.
- fusibili di protezione ausiliari e potenza
- sezionatore generale con blocco porta
- armadio metallico
- grado di protezione IP55
- temperatura ambiente: -5/+40°C
- umidità relativa a 40°C: 50% (non condensata)



The electromechanical control panels are developed for statoric impedance starting of a three-phase electropump and equipped with protections.

FEATURES:

- input voltage 3 ~ 50/60Hz 400V ± 10%
- transformer for auxiliary circuits 400+230/24V
- selector for Automatic (stable) - 0 - Manual (unstable)
- input for a float switch or a pressure switch
- blue led for power on
- green led for motor operating
- red led for motor protection alarm
- line contactor AC3 class
- impedance starter contactor AC3 class
- impedance starter
- n°4 starts per hour which not more than 2 consecutively
- acceleration time max. 15 s.
- overload thermal relay internally restorable
- timer for impedance release 0 ÷ 30 s.
- auxiliary circuits and motor protection fuses
- main switch with door interlock
- metallic cabinet
- index Protection IP55
- ambient temperature: -5/+40°C
- relative humidity at 40°C: 50% (condensate free)



Les coffrets électromécaniques de la série STA sont conçues pour le démarrage à impédance statorique de une électropompe triphasé et équipés de protections.

CARACTÉRISTIQUES:

- alimentation 3 ~ 50/60Hz 400V ± 10%
- transformateur pour circuits auxiliaires 400+230/24V
- sélecteur pour Automatique (stable) - 0 - Manuel (instable)
- entrée pour le flotteur ou le pressostat
- d.e.l. bleu de Présence réseau
- d.e.l. vert de moteur en fonction
- d.e.l. rouge d'alarme moteur en protection
- contacteur de ligne en classe AC3
- contacteur de démarrage de la impédance en classe AC3
- impédance de démarrage
- n°4 démarrages pour heures, pas plus que 2 consécutives
- temps de accélération max 15 s.
- relais thermique de surcharge à rétablissement manuel
- temporisateur pour relâcher l'impédance 0 ÷ 30 s.
- fusibles de protection moteur et auxiliaires
- sectionneur général avec verrouillage de la porte
- armoire métallique
- grade de protection IP55
- température du ambiant: -5/+40°C
- humidité relative à 40°C: 50% (non condensé)

QUADRO ELETTROMECCANICO CON AVVIAMENTO AD IMPEDENZA (STATORICO)

IMPEDANCE STARTING SYSTEM (STATORIC) ELECTROMECHANICAL PANEL

COFFRET ÉLECTROMÉCANIQUE AVEC DÉMARRAGE À IMPÉDANCE (STATORIQUE)

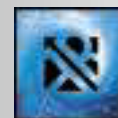



Tipo Type Type	Grado di protezione Index Protection Grade de protection	Potenza Power - Puissance		Corrente Max Max Current Courant Max	Dimensioni e Pesì Dimensions and Weight Dimensions et Poids			
		Cv Hp	Kw		A (mm)	B (mm)	P(mm)	KG
STA - 1 / 5,5	IP 55	5,5	4	9 ÷ 15	530	400	230	19
STA - 1 / 7,5		7,5	5,5	13 ÷ 18	530	400	230	19
STA - 1 / 10		10	7,5	17 ÷ 23	530	400	230	21
STA - 1 / 15		15	11	24 ÷ 32	530	400	230	22
STA - 1 / 20		20	15	32 ÷ 38	630	400	230	36
STA - 1 / 25		25	18,5	35 ÷ 50	630	400	230	36
STA - 1 / 30		30	22	46 ÷ 65	730	500	280	41
STA - 1 / 40		40	30	60 ÷ 82	840	600	330	41
STA - 1 / 50		50	37	70 ÷ 95	840	600	330	52
STA - 1 / 60		60	45	75 ÷ 125	840	600	330	78
STA - 1 / 75		75	55	90 ÷ 150	840	600	330	78
STA - 1 / 90		90	66	90 ÷ 150	1040	800	330	114
STA - 1 / 100		100	75	120 ÷ 162	1040	800	330	120
STA - 1 / 125		125	92	150 ÷ 250	1400	800	430	120
STA - 1 / 150		150	110	180 ÷ 300	1400	800	430	140
STA - 1 / 180		180	132	180 ÷ 300	1600	1000	430	150
STA - 1 / 220		220	162	250 ÷ 420	1600	1000	430	250
STA - 1 / 300	300	220	250 ÷ 420	1800	1000	430	290	

Optional:

CL/24	Controllo di livello (sonde escluse) - Level control for probes (probes excluded) for dry running protection - Contrôle de niveau pour sondes (sondes exclues) contre la marche à sec
Kit S/L	Kit sonda di livello - Kit level probes - Kit sondes de niveau
V500C	Kit voltmetro 500 Vfz - Voltmeter kit 500 Vfz - Kit voltmètre 500 Vfz
AC	Kit amperometro - Ammeter kit - Kit ampèremètre
CV3F	Commutatore voltmetrico - Voltmeter selector - Sélecteur voltmètre
CA3F	Commutatore amperometrico con 3 T.A. - Ammetric selector with 3 T.A. - Sélecteur ampèromètre avec 3 T.A.
CO-1	Contaore - Hour counter - Compte-heures
ASF400	Controllo sequenza e mancanza fasi - Wired control of sequence and lack of phases - Contrôle de séquence et manque phase
DRV400	Relè controllo di minima e massima tensione - Relay for control of min / max voltage - Relais de contrôle min / max tension

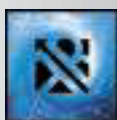



 I quadri elettromeccanici della serie DELTA sono per l'avviamento stella – triangolo sviluppati per il comando di un'elettropompa trifase e dotati di protezioni.

CARATTERISTICHE:

- ingresso rete 3 ~ 50/60Hz 400V ± 10%
- trasformatore per circuiti ausiliari 400+230/24V
- selettore Automatico (stabile) - 0 - Manuale (instabile)
- un ingresso galleggiante / pressostato
- luce spia blu di presenza rete
- luce verde di motore in funzione
- luce rossa di allarme motore in protezione
- contattore di linea di categoria AC3
- contattore di avviamento stella di categoria AC3
- contattore di marcia triangolo di categoria AC3
- relè termico di sovraccarico ripristinabile internamente
- temporizzatore di scambio stella - triangolo 0 ÷ 30 s.
- fusibili di protezione ausiliari e potenza
- sezionatore generale con blocco porta
- armadio metallico
- grado di protezione IP55
- temperatura ambiente: -5/+40°C
- umidità relativa a 40°C: 50% (non condensata)



 The electromechanical control panels range DELTA are developed for star - delta starting of a three-phase electropump and equipped with protections.

FEATURES:

- input voltage 3 ~ 50/60Hz 400V ± 10%
- transformer for auxiliary circuits 400+230/24V
- selector for Automatic (stable) - 0 - Manual (unstable)
- input for a float switch or a pressure switch
- blue led for power on
- green led for motor operating
- red led for motor protection alarm
- line contactor AC3 class
- contactor for star starting AC3 class
- contactor for delta working AC3 class
- overload thermal relay internally restorable
- timer for star - delta exchange 0 ÷ 30 s.
- auxiliary circuits and motor protection fuses
- main switch with door interlock
- metallic cabinet
- index Protection IP55
- ambient temperature: -5/+40°C
- relative humidity at 40°C: 50% (condensate free)

 Les coffrets électromécaniques de la série DELTA sont conçues pour le démarrage étoile - triangle de une électropompe triphasé et équipés de protections.

CARACTÉRISTIQUES:

- alimentation 3 ~ 50/60Hz 400V ± 10%
- transformateur pour circuits auxiliaires 400+230/24V
- sélecteur pour Automatique (stable) - 0 - Manuel (instable)
- entrée pour le flotteur ou le pressostat
- d.e.l. bleu de Présence réseau
- d.e.l. vert de moteur en fonction
- d.e.l. rouge d'alarme moteur en protection
- contacteur de ligne en classe AC3
- contacteur de démarrage étoile en classe AC3
- contacteur de marché triangle en classe AC3
- relais thermique de surcharge à rétablissement manuel
- temporisateur pour échange étoile - triangle 0 ÷ 30 s.
- fusibles de protection moteur et auxiliaires
- sectionneur général avec verrouillage de la porte
- armoire métallique
- grade de protection IP55
- température du ambient: -5/+40°C
- humidité relative à 40°C: 50% (non condensé)

QUADRO ELETTROMECCANICO CON AVVIAMENTO STELLA / TRIANGOLO

STAR / DELTA STARTING ELECTROMECHANICAL CONTROL PANEL

COFFRET ÉLECTROMÉCANIQUE AVEC DÉMARRAGE ÉTOILE / TRIANGLE

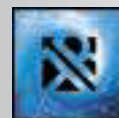

Tipo Type Type	Grado di protezione Index Protection Grade de protection	Potenza Power - Puissance		Corrente Max Max Current Courant Max	Dimensioni e Pesì Dimensions and Weight Dimensions et Poids			
		Cv Hp	Kw		A (mm)	B (mm)	P(mm)	KG
DELTA - 1 / 5,5	IP 55	5,5	4	8 ÷ 11,5	430	300	230	15
DELTA - 1 / 7,5		7,5	5,5	10 ÷ 14	430	300	230	15
DELTA - 1 / 10		10	7,5	10 ÷ 16	430	300	230	15
DELTA - 1 / 15		15	11	15 ÷ 20	430	300	230	15
DELTA - 1 / 20		20	15	24 ÷ 31	530	400	230	16
DELTA - 1 / 25		25	18,5	24 ÷ 36	530	400	230	16
DELTA - 1 / 30		30	22	34 ÷ 50	530	400	230	16
DELTA - 1 / 40		40	30	48 ÷ 62	530	400	230	20
DELTA - 1 / 50		50	37	60 ÷ 77	630	400	230	30
DELTA - 1 / 60		60	45	79 ÷ 98	730	500	280	30
DELTA - 1 / 75		75	55	93 ÷ 124	730	500	280	40
DELTA - 1 / 100		100	75	125 ÷ 135	730	500	280	40
DELTA - 1 / 125		125	92	125 ÷ 155	840	600	330	65
DELTA - 1 / 150		150	110	130 ÷ 195	840	600	330	65
DELTA - 1 / 180		180	132	155 ÷ 241	1040	800	330	70
DELTA - 1 / 220		220	162	210 ÷ 290	1040	800	330	80
DELTA - 1 / 300		300	220	260 ÷ 410	1240	800	330	100

Optional:

CL/24	Controllo di livello (sonde escluse) - Level control for probes (probes excluded) for dry running protection - Contrôle de niveau pour sondes (sondes exclues) contre la marche à sec
Kit S/L	Kit sonda di livello - Kit level probes - Kit sondes de niveau
V500C	Kit voltmetro 500 Vfz - Voltmeter kit 500 Vfz - Kit voltmètre 500 Vfz
AC	Kit amperometro - Ammeter kit - Kit ampèremètre
CV3F	Commutatore voltmetrico - Voltmeter selector - Sélecteur voltmètre
CA3F	Commutatore amperometrico con 3 T.A. - Ammetric selector with 3 T.A. - Sélecteur ampèremètre avec 3 T.A.
CO-1	Contaore - Hour counter - Compte-heures
ASF400	Controllo sequenza e mancanza fasi - Wired control of sequence and lack of phases - Contrôle de séquence et manque phase
DRV400	Relè controllo di minima e massima tensione - Relay for control of min / max voltage - Relais de contrôle min / max tension



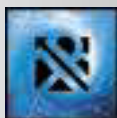

 **PT 100**

Per aumentare il grado di sicurezza dell'impianto di prelievo dell'acqua, è possibile inserire all'interno del motore da 6" a 10" una termoresistenza PT 100 in grado di monitorare costantemente e in modo preciso la temperatura interna del motore.

La sonda deve essere collegata ad un controllore di temperatura LT110, il quale verifica che il motore rimanga entro i limiti stabiliti per un suo corretto funzionamento. Se la temperatura eccede il limite consentito, il controllore interverrà bloccando il funzionamento del motore.

 **PT 100**

In order to enhance the security level of the water supply system, it is possible to insert inside the motor from 6" to 10" a thermoresistance called PT 100 which constantly and primly controls the internal temperature of the motor.

The probe has to be connected to a temperature controller LT110 who checks that the motor respects the values established for the correct working. If the temperature exceeds the allowed limits the controller will block the motor.

 **PT 100**

Pour augmenter le niveau de sûreté de l'installation d'approvisionnement hydrique, on peut introduire dans les moteurs de 6" à 10" une thermo-résistance PT100 pour tenir sous contrôle constamment et précisément la température du moteur.

Le capteur doit être relié à un appareil de contrôle LT110, qui doit vérifier que le moteur respecte les limites établis pour un correct fonctionnement. Si la température excède le limite consenti, l'appareil de contrôle bloquera le moteur.

Tipo Type Type	Costruzione Construction Construction	Attacco Connection Coupling	Lunghezza Cavo Lenght of the cable Longueur du câble
PT 100	AISI 316	G 1/4"	4 mt



 **TERMOCONTROLLORE DIGITALE A QUADRO PER LA PROTEZIONE MOTORE**

Termocontrollore da inserire opportunamente nel quadro, idoneo per rilevare la temperatura interna del motore sommerso attraverso una sonda PT 100. Il controllore interviene se il motore fuoriesce dai limiti impostati. Lo strumento agisce interrompendo l'alimentazione al motore attraverso il contattore di linea nel quadro.

È possibile usufruire di un'ulteriore uscita presente nel regolatore, che può essere utilizzata per segnalazione allarmi.

 **DIGITAL INDICATING CONTROLLER FOR THE MOTOR PROTECTION**

Thermocontroller to be inserted in the control panel, suitable for the submersible motor temperature survey by PT 100 temperature sensor.

The controller act if the motor exceed the presetted thresholds. The thermocontroller operates interrupting the motor supply by the line contactor inside the control panel.

It is possible to avail another output of the regulator, that may be used for alarm warnings.

 **APPAREIL DE CÔNTROL DE LA TEMPÉRATURE DU MOTEUR POUR L'INSERTION DANS LE COFFRET ÉLECTRIQUE**

Appareil de control de la température pour l'insertion dans le coffret électrique, apte à relever la température intérieure du moteur immergé par une capteur de température PT100.

L'appareil intervient si le moteur déborde les limites établis, il agit en interrompant l'alimentation du moteur par le contacteur de ligne dans le coffret électrique. Il est possible utiliser l'autre sortie qui peut être utilisée pour signaler un alarme.

Tipo Type Type	Tensione di utilizzo Voltage Tension
LT110	100 - 240 V



Sonde di livello

Level probes
Sondes de niveau

Tipo Type Type	Quantità Quantity Quantité
Kit S/L	nr. 3



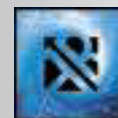

 **GALLEGGIANTI**

Per controllare e regolare costantemente il livello dell'acqua all'interno di vasche o cisterne, in riempimento o svuotamento, si consiglia l'utilizzo di galleggianti della serie FLOAT. La chiusura ermetica mediante una iniezione di poliuretano li protegge dalle infiltrazioni di acqua e condensa.

CARATTERISTICHE:

- Pressione massima di lavoro 10 bar (100 m di profondità)
- Tensione di esercizio 250 V
- Carico resistivo: • 2 HP (20 A) per FLOAT
• 10 A per FLOAT-DRINK e FLOAT-DIRTY
- Temperatura massima di lavoro 60°C

APPLICAZIONI:

- Serie FLOAT: acque in generale;
- Serie FLOAT - DRINK: acque potabili (con certificato per la potabilità "WRAS");
- Serie FLOAT - DIRTY: acque sporche e luride.

 **FLOATS**

To control constantly the level of the water in tanks or cisterns, filling or emptying, it is recommended to use the float. Floats are protected from infiltration and condensation by means of a polyurethane injection.

FEATURES:

- Max pressure 10 bar (100 m depth)
- Rated voltage 250 V
- Resistive load: • 2 HP (20 A) for FLOAT range
• 10 A for FLOAT-DRINK and FLOAT-DIRTY
- Max working temperature 60°C

APPLICATIONS:

- FLOAT range: water general application;
- FLOAT - DRINK range: drinkable water (WRAS approved);
- FLOAT - DIRTY range: dirty and filthy water;

 **FLOTTEURS**

Pour contrôler et régler constamment le niveau de l'eau dans réservoir ou citerne, pour remplir ou vider, on conseille le flotteur de la gamme FLOAT. Une injection de polyuréthane protège les flotteurs de l'infiltration et de la condensation.

CARACTÉRISTIQUES:

- Pression maximale 10 bar (profondeur 100 m)
- Tension 250 V
- Charge: • 2 HP (20 A) pour FLOAT
• 10 A pour FLOAT-DRINK et FLOAT-DIRTY
- Température maximale: 60°C

APPLICATIONS:

- Type FLOAT: eau en général;
- Type FLOAT - DRINK: eau potable (certifié "WRAS");
- Type FLOAT - DIRTY: eau sale et dégoûtant.

Tipo Type Type	Corrente (A) Current (A) Courant (A)	Cavo-Cable-Câble		
		Tipo Type Type	Sezione Section Section	Lunghezza Length Longueur (m)

Interruttore-svuotamento - Switch-emptying - Interrupteur-vidange

FLOAT I/05-N	10(8)A 250V 2HP	H07RN-F	3G1	0,5
---------------------	-----------------	---------	-----	-----

Commutatore riempimento-svuotamento - Selector filling-emptying - Sélecteur remplissage-vidage

FLOAT C/3-P	10(8)A 250V 2HP	PVC A05VVF	3x1	3
FLOAT C/5-P		PVC A05VVF	3x1	5
FLOAT C/10-P		PVC A05VVF	3x1	10

FLOAT C/05-N	10(8)A 250V 2HP	H07RN-F	3x1	0.5
FLOAT C/5-N		H07RN-F	3x1	5
FLOAT C/10-N		H07RN-F	3x1	10
FLOAT C/20-N		H07RN-F	3x1	20
FLOAT C/30-N		H07RN-F	3x1	30

FLOAT-DRINK C/5	10(4)A 250V	EPR WRAS	3x1	5
FLOAT-DRINK C/10		EPR WRAS	3x1	10
FLOAT-DRINK C/20		EPR WRAS	3x1	20
FLOAT-DRINK C/30		EPR WRAS	3x1	30

FLOAT-DIRTY C/5	10A 250V	RF60 A05VVF	3x1	5
FLOAT-DIRTY C/10		RF60 A05VVF	3x1	10
FLOAT-DIRTY C/20		RF60 A05VVF	3x1	20
FLOAT-DIRTY C/30		RF60 A05VVF	3x1	30

CONTRAPPESO grammi 100 - Counterweight 100 grams - Counterpoinds 100 grammes



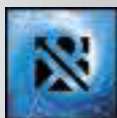

 **CONDENSATORI**

Il condensatore dielettrico è in film di polipropilene, le armature sono costituite da un sottilissimo deposito metallico ottenuto per evaporazione sottovuoto.

Custodia e coperchio sono realizzati in materiale plastico autoestinguente; l'elemento capacitivo viene sigillato con resina poliuretanicca.

Le caratteristiche principali di queste serie di condensatori sono:

- avvolgimento antinduttivo a basse perdite
- proprietà auto-rigeneranti che impediscono il cortocircuito
- piccole dimensioni e peso contenuto
- il condensatore è assolutamente esente da rischi di perdite di liquido
- classe di sicurezza: P0

CARATTERISTICHE TECNICHE

- tolleranza di capacità: $\pm 5\%$
- frequenza di lavoro: $50 \div 60$ Hz
- grado di protezione: IP00 per FASTON; IP20 per cavetti unipolari

Tipo Type Type	Capacità Capacity Capacité [μ F]	Tensione Voltage Voltage [V~]	Classe Class Classe	Frequenza Frequency Fréquence [Hz]
F5	5	475	C	50 \div 60
F10	10	475	C	50 \div 60
F12,5	12,5	475	C	50 \div 60
F14	14	475	C	50 \div 60
F16	16	475	C	50 \div 60
F20	20	475	C	50 \div 60
F25	25	475	C	50 \div 60
F30	30	475	C	50 \div 60
F35	35	475	C	50 \div 60
F40	40	475	C	50 \div 60
F45	45	450	C	50 \div 60
F50	50	450	C	50 \div 60
F55	55	450	C	50 \div 60
F60	60	450	C	50 \div 60
F70	70	450	C	50 \div 60
F75	75	450	C	50 \div 60
F80	80	450	C	50 \div 60
F90	90	450	C	50 \div 60

Tipo Type Type	Capacità Capacity Capacité [μ F]	Tensione Voltage Voltage [V~]	Classe Class Classe	Frequenza Frequency Fréquence [Hz]
C5	5	475	C	50 \div 60
C10	10	475	C	50 \div 60
C12,5	12,5	475	C	50 \div 60
C14	14	475	C	50 \div 60
C16	16	475	C	50 \div 60
C20	20	475	C	50 \div 60
C25	25	475	C	50 \div 60
C30	30	475	C	50 \div 60
C35	35	475	C	50 \div 60
C40	40	475	C	50 \div 60
C45	45	450	C	50 \div 60
C50	50	450	C	50 \div 60
C55	55	450	C	50 \div 60
C60	60	450	C	50 \div 60
C70	70	450	C	50 \div 60
C75	75	450	C	50 \div 60
C80	80	450	C	50 \div 60
C90	90	450	C	50 \div 60

 **CAPACITORS**

The dielectric capacitor is in polypropylene film, the electrodes consist of an extremely thin metal coating obtained by vacuum evaporation.

Case and cover are made with self-extinguishing plastic material, the capacitive element is sealed with polyurethanic resin.

The main characteristics of these capacitors are:

- low losses non-inductive winding
- self-healing property avoiding short circuits
- small size and limited weight
- no leakage risk
- class of safety protection: P0

FEATURES

- capacity tolerance: $\pm 5\%$
- voltage: $50 \div 60$ Hz
- index protection: IP00 for FASTON; IP20 for unipolar wires

 **CONDENSATEUR**

Le condensateur électrique est en film de polypropylène, les armatures sont constituées par un fin dépôt métallique obtenu par évaporation en vide.

Le boîtier et le couvercle sont réalisés en matériel plastique auto-éteignant; l'élément capacitif est scellé avec résine polyuréthénique.

Les caractéristiques principales sont :

- bobinage inductif avec basses pertes
- propriété pour empêcher le court-circuit
- petite dimension et poids contenu
- pas des pertes de liquide
- classe de sûreté: P0

CARACTÉRISTIQUES

- tolérance de capacité: $\pm 5\%$
- tension: $50 \div 60$ Hz
- grade de protection: IP00 pour FASTON; IP20 pour câbles unipolaires



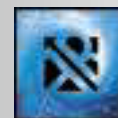

 **CAVO DRINCABLE**

Cavo flessibile con isolante e guaina in gomma EPR adatto per l'immersione permanente in acqua potabile. Il cavo Drincable è atossico ed impermeabile ed è stato approvato da WRAS, ACS e KTW secondo la BS 6920: essa conferma che non avvengono alterazioni alle colonie di microorganismi già presenti nell'acqua in seguito all'immersione del cavo nell'acqua stessa.

 **DRINCABLE CABLE**

Flexible cable with isolating and sheath in EPR rubber suitable for permanent immersion in drinking-water. The Drincable cable is non toxic and waterproof and it has been approved by WRAS, ACS and KTW according to BS 6920: it states that colonies of microorganism of the water are not altered by the cable sample immersed in it.

 **CÂBLE DRINCABLE**

Câble flexible avec isolant et gaine en caoutchouc EPR apte à l'immersion permanent dans l'eau potable. Le câble Drincable est atoxique et imperméable, il est approuvé par WRAS, ACS et KTW selon BS 6920: elle déclare que il n'y a aucune altération aux colonies de micro-organismes qui se trouvent dans l'eau après avoir introduit un échantillon de câble.

Cavo di alimentazione Drincable in EPR certificato WRAS, ACS e KTW per la potabilità

Power supply cable Drincable type in EPR approved WRAS, ACS and KTW for drinking water

Câble d'alimentation type Drincable en EPR certifié WRAS, ACS et KTW pour l'eau potable

Sezione cavi Section of the cables Section des câbles	Tipo Type Type	Diametro Esterno Massimo Maximum Overall Diameter Diamètre Extérieur Maximal (mm)	Peso dei cavi Cables Weight Poids des câbles (Kg/mt)	Tensione di esercizio Rated voltage Tension de fonctionnement	Temperatura di esercizio Operation temperature Température de fonctionnement
4 x 1,5 mm ²	Cavo EPR EPR Cable Câble EPR	11,8	0,18	0,6 / 1 kV	min - 40°C max +90°C
4 x 2,5 mm ²		14	0,26		
4 x 4 mm ²		16,1	0,36		
4 x 6 mm ²		18	0,48		
4 x 10 mm ²		23,9	0,84		
4 x 16 mm ²		27,1	1,15		
4 x 25 mm ²		32,9	1,72		
4 x 35 mm ²		37	2,31		
4 x 50 mm ²		42,8	3,13		
1 x 4 mm ²		8,1	0,09		
1 x 6 mm ²		8,8	0,12		
1 x 10 mm ²		10,7	0,18		
1 x 16 mm ²		12,1	0,25		
1 x 25 mm ²		14,2	0,36		
1 x 35 mm ²		16,1	0,50		
1 x 50 mm ²		18,5	0,67		
1 x 70 mm ²		21	0,90		
1 x 95 mm ²		23,4	1,14		
1 x 120 mm ²		25,7	1,44		
1 x 150 mm ²		28,3	1,79		
3 x 4 mm ²		15,6 x 7	0,23		
3 x 6 mm ²		17,8 x 8,9	0,30		
3 x 10 mm ²		24,5 x 11	0,48		
3 x 16 mm ²		29 x 12,8	0,68		
3 x 25 mm ²		33,7 x 13,8	1,00		



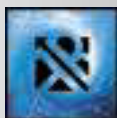

 **CAVO NEOPRENE H07RN-F**

Cavo flessibile isolato in gomma con guaina in neoprene H07RN-F, la quale conferisce buona resistenza alle sollecitazioni meccaniche, all'olio, agli agenti chimici ed atmosferici.

La qualità dei materiali usati rendono questo cavo particolarmente affidabile dal punto di vista della sicurezza di esercizio.

Esso può essere utilizzato in ambienti interni o esterni, umidi o bagnati.

 **NEOPRENE H07RN-F CABLE**

Rubber-insulated flexible cable with neoprene H07RN-F sheathing resistant to mechanical stresses, oils, chemical corrosion and weathering.

The high quality materials used for this cable ensure maximum reliability on the operating security. It can be used in internal or external environment, damp or wet.

 **NÉOPRÈNE H07RN-F CÂBLE**

Câble flexible isolé en caoutchouc avec gaine en néoprène H07RN-F, elle confère bonne résistance aux sollicitations mécaniques, à l'huile, aux agents chimiques et atmosphériques.

La qualité des matériaux utilisés rendent ce câble particulièrement fiable pour ce qui concerne la sûreté de l'emploi. Il peut être utilisé en milieu intérieur ou extérieur, humides ou mouillés.

Cavo di alimentazione in neoprene H07RN-F per sonde

Power supply cable for probes in neoprene H07RN-F

Câble d'alimentation pour sondes en néoprène H07RN-F

Sezione cavi Section of the cables Section des câbles	Tipo Type Type	Diametro Esterno Massimo Maximum Overall Diameter Diamètre Extérieur Maximal (mm)	Peso dei cavi Cables Weight Poids des câbles (Kg/mt)	Tensione di esercizio Rated voltage Tension de fonctionnement	Temperatura di esercizio Operation temperature Température de fonctionnement
3 x 0,75 mm ²	Neoprene H07RN-F Neoprene H07RN-F Néoprène H07RN-F	8,1	0,07	450 / 750 V	min -40°C max +60°C
3 x 1,5 mm ²		11,9	0,15		
3 x 2,5 mm ²		14	0,21		



Cavo di alimentazione in neoprene H07RN-F

Power supply cable in neoprene H07RN-F

Câble d'alimentation en néoprène H07RN-F

Sezione cavi Section of the cables Section des câbles	Tipo Type Type	Diametro Esterno Massimo Maximum Overall Diameter Diamètre Extérieur Maximal (mm)	Peso dei cavi Cables Weight Poids des câbles (Kg/mt)	Tensione di esercizio Rated voltage Tension de fonctionnement	Temperatura di esercizio Operation temperature Température de fonctionnement
4 x 1,5 mm ²	Neoprene H07RN-F Neoprene H07RN-F Néoprène H07RN-F	13,1	0,19	450 / 750 V	min -40°C max +60°C
4 x 2,5 mm ²		15,5	0,26		
4 x 4 mm ²		17,9	0,35		
4 x 6 mm ²		20	0,46		
4 x 10 mm ²		26,5	0,83		
4 x 16 mm ²		30,1	1,19		
4 x 25 mm ²		36,6	1,72		
4 x 35 mm ²		41,1	2,26		
4 x 50 mm ²		47,5	3,14		
1 x 16 mm ²		13,4	0,28		
1 x 25 mm ²		15,8	0,40		
1 x 35 mm ²		17,9	0,51		
1 x 50 mm ²		20,6	0,71		
1 x 70 mm ²		23,3	0,95		
1 x 95 mm ²		26	1,20		
1 x 120 mm ²		28,6	1,50		
1 x 150 mm ²	31,4	1,85			



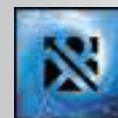

 **KIT PER UNA GIUNZIONE A REGOLA D'ARTE**

Per una giunzione eseguita a regola d'arte si consiglia l'uso del kit "LINK" il quale possiede ottimi requisiti in termini di resistenza elettrica, meccanica e all'acqua. Il kit è così composto: connettori testa-testa a crimpare in rame stagnato, termorestringenti a basso spessore per la copertura di ogni conduttore del cavo, una striscia di Scotch 2547, una di Scotchfil e termorestringente a medio spessore per la copertura della giunzione. Si consiglia la sigillatura delle due estremità con un nastro con supporto in PVC.

 **KIT FOR A PROFESSIONALLY MADE JUNCTION**

For a professionally made junction it is recommended to use LINK kit, it has excellent requirements in terms of electric, mechanical and water resistance.

This kit is composed of: crimp wire connectors in tinned copper, thin wall heat-shrinkable tubing to cover the conductor of the cable, a strip of Scotch 2547, one of Scotchfil and medium wall heat-shrinkable tubing to cover the junction.

It is recommended to seal the two end points of the sheath with a PVC textured insulating tape.

 **KIT POUR UNE JONCTION PROFESSIONNELLE**

Pour une jonction fait professionnellement on conseille le kit LINK, qui possède bonne résistance électrique, mécanique et à l'eau.

Le kit est composé par: connecteur tête-tête à pincer en cuivre étamé, fourreau thermo-rétractable à paroi mince pour couvrir le conducteur du câble, une bande de Scotch 2547, une de Scotchfil et fourreau thermo-rétractable à paroi moyenne pour couvrir la jonction.

On conseille de sceller les deux extrémités avec un bande avec soutien en PVC.

Kit giunzione cavo con termorestringente

Junction cable kit with heat - shrinkable tubing

Kit jonction câble avec fourreau thermo - rétractable

Tipo Type Type	Sezione cavi Cables section Section des câbles	Numero conduttori Number of the conductor Nombre du conducteur
LINK 4/2,5	1/2,5 mm ²	4
LINK 4/6	4/6 mm ²	4
LINK 4/10	10 mm ²	4
LINK 4/16	16 mm ²	4
LINK 4/25	25 mm ²	4
LINK 4/35	35 mm ²	4
LINK 4/50	50 mm ²	4
LINK 1/4	4 mm ²	1
LINK 1/6	6 mm ²	1
LINK 1/10	10 mm ²	1
LINK 1/16	16 mm ²	1
LINK 1/25	25 mm ²	1
LINK 1/35	35 mm ²	1
LINK 1/50	50 mm ²	1
LINK 1/70	70 mm ²	1
LINK 1/95	95 mm ²	1
LINK 1/120	120 mm ²	1
LINK 1/150	150 mm ²	1



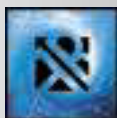

 **GUAINA TERMORESTRINGENTE**

La guaina termorestringente di poliolefina modificata è indicata per garantire la sigillatura e la protezione di componenti a bassa tensione.

E' infatti utilizzata per il ripristino dell'isolamento e della copertura esterna di cavi bassa tensione e ovunque siano richieste ottime caratteristiche di resistenza meccanica all'impatto, all'abrasione, agli agenti atmosferici e per l'impiego in ambienti sommersi.

La guaina si suddivide in due tipologie: a basso spessore e a medio spessore di parete.

All'interno è dotata di un adesivo termofondente che garantisce un'elevata tenuta all'acqua, questo è più consistente nella tipologia di medio spessore di parete.

 **HEAT-SHRINKABLE TUBING**

The heat-shrinkable tubing of modified polyolefin is used for sealing and protecting low voltage components.

It is used to restore the insulation and the cable coating and anywhere first-rate mechanical resistance to impact, abrasion and to atmospheric agents are requested.

It's suitable also to be used in submerged areas.

The tubing is divided into two classes: thin and medium wall thickness. Inside it has a heat-activated adhesive for watertight purposes, which is more substantial in the medium wall thickness type.

 **FOURREAU THERMO-RÉTRACTABLE**

Gaine thermo-rétractable en polyoléfine modifiée pour étancher et protéger les câbles à basse tension.

Indiquée dans des situations demandant d'excellentes caractéristiques de résistance mécanique à l'impact, à l'abrasion, aux agents atmosphériques ou pour utilisations en milieu submergé.

Le fourreau sont de deux type: à paroi mince et à paroi moyenne. À l'intérieur il y a un adhésif thermo-fondant pour une haute résistance à l'eau que est plus épais dans les fourreaux à paroi moyenne.

Termorestringenti a basso spessore

Thin wall heat-shrinkable tubing

Fourreau thermo-rétractable à paroi mince

Tipo Type Type	Diametro iniziale Initial diameter Diamètre initial [mm]	Diametro dopo termorestringimento Diameter after shrinkage Diamètre après thermorétrécissable [mm]	Lunghezza barre Lenght of the rods Longueur des barres
ATUM - 3/1	3	1	1,2
ATUM - 6/2	6	2	1,2
ATUM - 9/3	9	3	1,2
ATUM - 12/4	12	4	1,2
ATUM - 19/6	19	6	1,2
ATUM - 24/8	24	8	1,2
ATUM - 40/13	40	13	1,2

Termorestringenti a medio spessore

Medium wall heat-shrinkable tubing

Fourreau thermo-rétractable à paroi moyenne

Tipo Type Type	Diametro iniziale Initial diameter Diamètre initial [mm]	Diametro dopo completo termorestringimento Diameter after full heat-shrink Diamètre après plein thermorétrécissable [mm]	Lunghezza barre Lenght of the rods Longueur des barres
MTR 10/3	10	3	1
MTR 16/5	16	5	1
MTR 25/8	25	8	1
MTR 35/12	35	12	1
MTR 50/16	50	16	1
MTR 63/19	63	19	1
MTR 75/22	75	22	1



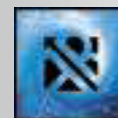

 **SCOTCH 2547**

Nastro isolante autoagglomerante a base di EPR, con separatore. Per la sua conformabilità si adatta perfettamente a qualsiasi contorno formando una massa omogenea e compatta.

IMPIEGHI PRINCIPALI:

- ricostruzione in opera dell'isolante primario dei cavi di bassa, media e alta tensione sino a 60kV

 **SCOTCH 2547**

EPR self-fusing insulating tape, with separator. Thanks to its conformability it perfectly adapts to any shape forming an homogeneous and dense mass.

APPLICATIONS:

- in-place reconstruction of the primary insulation on low, medium and high voltage cables up to 60kV

 **SCOTCH 2547**

Ruban EPR autoamalgamant isolant, avec intercalaire. Il s'adapte parfaitement et forme un tas homogène et compact.

APPLICATIONS:

- reconstruction de l'isolant dans les câbles de basse, moyenne et haute tension jusqu'à 60 kV

Tipo Type Type	Larghezza Width Largeur [mm]	Lunghezza Lenght Longueur [m]	Spessore Thickness Épaisseur [mm]
SCOTCH 2547	19	9	0,75



 **SCOTCHFIL**

Mastice isolante in gomma sintetica. Possiede eccellenti proprietà elettriche ed una buona resistenza all'invecchiamento; permette di riempire spazi vuoti e rientranze. Per un'efficace protezione meccanica, lo Scotchfil deve essere ricoperto con uno strato di Scotch 2547 e con nastro avente supporto in PVC (Scotchrap 50).

IMPIEGHI PRINCIPALI:

- ricostruzione in opera dell'isolante primario dei cavi a bassa tensione
- isolamento elettrico e protezione dei punti di giunzione
- isolamento e riempitivo di morsetti e terminali con forme irregolari

 **SCOTCHFIL**

Electrical insulation putty in synthetic rubber. It has excellent electrical properties and a good ageing resistance; it allows to fill up empty spaces and cavities. For an efficient mechanical protection, Scotchfil has to be coated with a layer of Scotch 2547 and a PVC textured tape (Scotch 50).

APPLICATIONS:

- in-place reconstruction of the primary insulation of low voltage cables
- electrical insulation and protection of junction point
- insulator and filler of clamps and terminals with irregular shape

 **SCOTCHFIL**

Mastic à base de caoutchouc synthétique. Il possède excellents propriétés électriques et bonne résistance au vieillissement, il permet aussi de remplir espaces vides et renforcements. Pour une efficace protection mécanique le ruban Scotchfil doit être fretté avec le ruban adhésif Scotchrap 50.

APPLICATIONS:

- reconstruction de l'isolant dans les câbles de basse tension
- isolation électrique et protection de la jonction
- isolation de bornes et terminal avec forme irrégulière

Tipo Type Type	Larghezza Width Largeur [mm]	Lunghezza Lenght Longueur [m]	Spessore Thickness Épaisseur [mm]
SCOTCHFIL	38	1,5	3,2



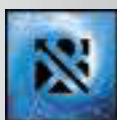

 **SCOTCH 2228**

Nastro isolante autoagglomerante formato da un supporto in EPR ed un mastice adesivo. Offre un'eccellente protezione contro la corrosione e gli agenti atmosferici.

IMPIEGHI PRINCIPALI:

- isolamento e protezione delle connessioni a bassa tensione

 **SCOTCH 2228 TAPE**

Self-fusing insulating tape formed by an EPR texture and by an adhesive rubber mastic. It provides an excellent protection against the corrosion and atmospheric agents.

APPLICATIONS:

- insulation and protection of low voltage connections

 **SCOTCH 2228**

Ruban EPR isolant autoamalgamant et avec mastic adhésif. Il garantit excellente protection contre la corrosion et les agents atmosphériques.

APPLICATIONS:

- isolation et protection des connexions à basse tension

Tipo Type Type	Larghezza Width Largeur [mm]	Lunghezza Lenght Longueur [m]	Spessore Thickness Épaisseur [mm]
SCOTCH 2228	50,8	3	1,65



 **SCOTCHRAP 50**

Nastro autoadesivo con supporto in PVC. Offre eccellenti proprietà fisiche, elettriche e meccaniche, ottima resistenza chimica alle muffe e microorganismi.

IMPIEGHI PRINCIPALI:

- protezione contro la corrosione e l'usura meccanica dei cavi elettrici e delle giunzioni tra cavi, interrati o esposti agli agenti atmosferici.

 **SCOTCHRAP 50 TAPE**

Self-adhesive tape with PVC texture. It provides excellent physical, electrical and mechanical properties, great chemical resistance to mould and microorganism.

APPLICATIONS:

- protection against corrosion and wear of electric cables and cable junctions

 **SCOTCHRAP 50**

Ruban adhésif avec soutien en PVC. Il garantit excellentes propriétés physiques, électriques et mécaniques et aussi excellente résistance chimique aux moisissures et aux micro-organismes.

APPLICATIONS:

- protection contre la corrosion et l'usure mécanique des câbles et des jonction

Tipo Type Type	Larghezza Width Largeur [mm]	Lunghezza Lenght Longueur [m]	Spessore Thickness Épaisseur [mm]
SCOTCHRAP 50	25	30,5	0,25



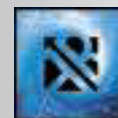

Pressostati

Pressure switch
Interrupteur de pression

Tipo Type Type	Utilizzo alimentazione Availment supply Utilisation source	Attacco Connection Connexion	Taratura standard Standard calibration Étalonnage standard (bar)
PS1	1 ~ 230V	¼" femmina - female - femelle	1,4 ÷ 2,8
PS2	1 ~ 230V	¼" femmina - female - femelle	5 ÷ 7
PS3	1 ~ 230V	¼" femmina - female - femelle	8 ÷ 10,5
PS1T	3 ~ 400V	¼" femmina - female - femelle	1,4 ÷ 2,8
PSG1	1 ~ 230V	¼" femmina girevole ¼" female revolving - ¼" femelle tournant	1,4 ÷ 2,8

Possibilità di taratura personalizzata per ogni singolo pressostato
Personalized calibration for each pressure switch
Possibilité de calibrage personnalisé pour chaque interrupteur de pression



Manometri

Pressure gauges
Manomètres

Tipo Type Type	Diametro Diameter Diamètre (mm)	Attacco Connection Connexion	Campo di lavoro Working range Plage de travail (bar)
PG-C6	50	¼" centrale - central - central	0 ÷ 6
PG-R6	63	¼" radiale - radial - radial	0 ÷ 6
PG-R10	63	¼" radiale - radial - radial	0 ÷ 10
PGG-C6	63	¼" centrale - central - central	0 ÷ 6
PGG-R6	63	¼" radiale - radial - radial	0 ÷ 6
PGG-R10	63	¼" radiale - radial - radial	0 ÷ 10
PGG-R16	63	¼" radiale - radial - radial	0 ÷ 16
PGG-R25	63	¼" radiale - radial - radial	0 ÷ 25
PGG-R40	63	¼" radiale - radial - radial	0 ÷ 40



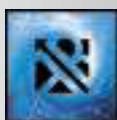

Serbatoio sferico

Spherical pressure tanks
Vases d'expansion sphériques

TEMPERATURA

TEMPERATURE -10°C / + 99°C
TEMPÉRATURE

Tipo Type Type	Capacità Capacity Capacité (Lt)	Pressione massima Max pressure Pression maximale (Bar)	Raccordo Connection Raccord	Dimensioni Dimensions Dimension (mm)
24SF8	24	8	1"	351 x 347

Membrana - Membrane - Membrane

Tipo - Type - Type	Materiale - Material - Material	Capacità - Capacity - Capacité (Lt)
24SF8M	EPDM	24



Serbatoi verticali

Vertical pressure tanks
Vases d'expansion vertical

TEMPERATURA

TEMPERATURE -10°C / + 99°C
TEMPÉRATURE

Tipo Type Type	Capacità Capacity Capacité (Lt)	Pressione massima Max pressure Pression maximale (Bar)	Raccordo Connection Raccord	Dimensioni Dimensions Dimension (mm)
5V8	5	8	1"	160 x 332
8V8	8	8	1"	200 x 348
12V8	12	8	1"	270 x 308
19V8	19	8	1"	270 x 410



Membrana - Membrane - Membrane

Tipo - Type - Type	Materiale - Material - Material	Capacità - Capacity - Capacité
5V8M	EPDM	5 lt.
8V8M		8 lt.
12V8M		12 lt.
19V8M		19 lt.



Serbatoi per pressoflussostato

Pressure tanks for pump controller
Vases d'expansion pour régulateur de pression électronique

TEMPERATURA

TEMPERATURE -10°C / + 99°C
TEMPÉRATURE

Tipo Type Type	Capacità Capacity Capacité (Lt)	Pressione massima Max pressure Pression maximale (Bar)	Raccordo Connection Raccord	Dimensioni Dimensions Dimension (mm)
3V10	3	10	1"M + 1"F	265 x 170
8V10	8	10	1"M + 1"F	385 x 230



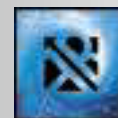

Serbatoi Orizzontali
Horizontal pressure tanks
Vases d'expansion horizontal

TEMPERATURA
TEMPERATURE
TEMPÉRATURE
-10°C / + 99°C

Tipo Type Type	Capacità Capacity Capacité (Lt)	Pressione massima Max pressure Pression maximale (Bar)	Raccordo Connection Raccord	Dimensioni Dimensions Dimension (mm)
20H10	20	10	1"	274 x 497
50H10	50	10	1"	410 x 610
60H10	60	10	1"	410 x 670
80H10	80	10	1"	479 x 637
100H10	100	10	1"	485 x 756
200H10	200	10	1"1/2	602 x 1038
300H10	300	10	1"1/2	654 x 1188

Membrana - Membrane - Membrane

Tipo - Type - Type	Materiale - Material - Material	Capacità - Capacity - Capacité (Lt)
20H10M	EPDM	20
50H10M		50
60H10M		60
80H10M		80
100H10M		100
200H10M		200
300H10M		300



Serbatoi verticali
Vertical pressure tanks
Vases d'expansion vertical

TEMPERATURA
TEMPERATURE
TEMPÉRATURE
-10°C / + 99°C

Tipo Type Type	Capacità Capacity Capacité (Lt)	Pressione massima Max pressure Pression maximale (Bar)	Raccordo Connection Raccord	Dimensioni Dimensions Dimension (mm)
50V10	50	10	1"	379 x 759
60V10	60	10	1"	379 x 825
80V10	80	10	1"	450 x 789
100V10	100	10	1"	450 x 910
150V10	150	10	1"1/2	554 x 1040
200V10	200	10	1"1/2	554 x 1250
300V10	300	10	1"1/2	624 x 1370
500V10	500	10	1"1/2	775 x 1460
750V10	750	10	1"1/2	790 x 1925
1000V10	1000	10	2"	945 x 1912
2000V10	2000	10	2"	1280 x 2080



Membrana - Membrane - Membrane

Tipo - Type - Type	Materiale - Material - Material	Capacità - Capacity - Capacité (Lt)
50V10M	EPDM	50
60V10M		60
80V10M		80
100V10M		100
150V10M		150
200V10M		200
300V10M		300
500V10M		500
750V10M		750
1000V10M		1000
2000V10M		2000



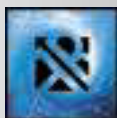

CAMICIE DI RAFFREDDAMENTO

COOLING SLEEVES

CHEMISES DE REFROIDISSEMENT



Le camicie di raffreddamento per pompe sommerse garantiscono un miglioramento nel funzionamento del motore sommerso, consentendo la dispersione del calore attraverso il passaggio dell'acqua al suo interno.

Se ne consiglia l'uso quando la velocità del fluido non sarà in grado di raffreddare il motore, come in caso di diametro del pozzo molto più grande del diametro della pompa o di installazione in vasca.

Per la versione orizzontale, la camicia di raffreddamento è dotata di supporti di sostegno.

COSTRUZIONE:

- tubo di raffreddamento: acciaio inox AISI 304
- staffe di supporto: acciaio inox AISI 304
- anello di tenuta: gomma
- viteria in acciaio inox AISI 304

APPLICAZIONI:

- cisterne
- serbatoi
- laghi
- pozzi di grandi dimensioni rispetto al diametro dell'elettropompa
- pozzi dove l'elettropompa è installata sotto il filtro del pozzo



Cooling sleeves for submersible pumps guarantee the improvement of submersible motor working, as they allow heat loss through water flow in the cooling sleeve.

It is recommended to use the cooling sleeve when the speed of the water cannot cool down the motor, like for example when the diameter of the well is greater than the diameter of the pump or when the pump is installed in a tank.

For horizontal application, the cooling sleeve is supplied with retaining structure.

CONSTRUCTION:

- cooling sleeve: stainless steel AISI 304
- retaining structure: stainless steel AISI 304
- o-ring: rubber
- bolt and screws: stainless steel AISI 304

APPLICATIONS:

- tank
- reservoir
- lakes
- well greater than the diameter of the pump
- well where the pump is installed below the filter of the well



Les chemises de refroidissement pour les pompes immergées garantissent un meilleur fonctionnement du moteur immergé, en permettant la dispersion de la chaleur grâce au passage de l'eau dans la chemise de refroidissement.

On conseille l'utilisation de la chemise de refroidissement quand l'eau ne peut pas refroidir le moteur, ou par exemple le diamètre du puit est plus grand du diamètre de la pompe ou quand on installe la pompe dans un bassin de recueil.

Pour l'installation horizontale, la chemise de refroidissement est équipée avec supports de soutien.

CONSTRUCTION:

- chemise de refroidissement: acier inoxydable AISI 304
- support de soutien: acier inoxydable AISI 304
- o-ring: caoutchouc
- visserie: acier inoxydable AISI 304

APPLICATIONS:

- citerne
- réservoir
- lac
- puits de dimension très grands respect au diamètre de la pompe
- puits où la pompe est installée au-dessous du filtre du puit



CAMICIE DI RAFFREDDAMENTO

COOLING SLEEVES

CHEMISES DE REFROIDISSEMENT

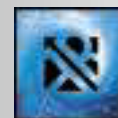

Camicia di raffreddamento orizzontale

Horizontal cooling sleeve

Chemise de refroidissement horizontale

Tipo Type Type	Sezione motore Section of the motor Section du moteur	Potenza motore Motor Power Puissance du moteur
4X0500-H	Motore 4" - 4" Motor - Moteur 4"	Fino a 10 HP - Up to 10 HP - Jusqu'à 10 HP
4X1000-H	Motore 4" - 4" Motor - Moteur 4"	Fino a 4 HP - Up to 4 HP - Jusqu'à 4 HP
6X1000-H	Motore 6" - 6" Motor - Moteur 4"	Fino a 20 HP - Up to 20 HP - Jusqu'à 20 HP
6X1500-H	Motore 6" - 6" Motor - Moteur 6"	Fino a 60 HP - Up to 60 HP - Jusqu'à 60 HP



Camicia di raffreddamento verticale

Vertical cooling sleeve

Chemise de refroidissement verticale

Tipo Type Type	Sezione motore Section of the motor Section du moteur	Potenza motore Motor Power Puissance du moteur
4X0500-V	Motore 4" - 4" Motor - Moteur 4"	Fino a 4 HP - Up to 4 HP - Jusqu'à 4 HP
4X1000-V	Motore 4" - 4" Motor - Moteur 4"	Fino a 10 HP - Up to 10 HP - Jusqu'à 10 HP
6X1000-V	Motore 6" - 6" Motor - Moteur 4"	Fino a 20 HP - Up to 20 HP - Jusqu'à 20 HP
6X1500-V	Motore 6" - 6" Motor - Moteur 6"	Fino a 60 HP - Up to 60 HP - Jusqu'à 60 HP



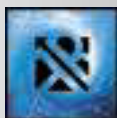

Testata pozzo

Wellhead for the closure of the well

Tête pour la fermeture du puits

Tipo Type Type	Diametro esterno pozzo External well diameter Diamètre extern puit
115 x 1" 1/4	115 mm
115 x 1" 1/2	115 mm
115 x 2"	115 mm
125 x 1" 1/4	125 mm
125 x 1" 1/2	125 mm
125 x 2"	125 mm
140 x 1" 1/4	140 mm
140 x 1" 1/2	140 mm
140 x 2"	140 mm
160 x 1" 1/4	160 mm
160 x 1" 1/2	160 mm
160 x 2"	160 mm
160 x 2" 1/2	160 mm
170 x 1" 1/4	170 mm
170 x 1" 1/2	170 mm
170 x 2"	170 mm
170 x 2" 1/2	170 mm
180 x 1" 1/4	180 mm
180 x 1" 1/2	180 mm
180 x 2"	180 mm
180 x 2" 1/2	180 mm
180 x 3"	180 mm
200 x 2"	200 mm
200 x 2" 1/2	200 mm
200 x 3"	200 mm
200 x 4"	200 mm

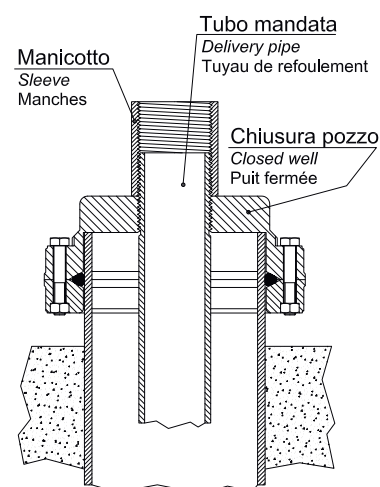

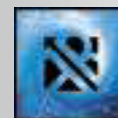

Fune in acciaio inox per ancoraggio pompa

Stainless steel rope for the anchorage of the pump
Cordage en acier inoxydable pour l'ancrage de la pompe

Tipo Type Type	Diametro Diameter Diamètre	Peso Weight Poids (kg/m)	Carico di rottura Tensile strength Charge de rupture (kg)
Fune - Rope - Cordage AISI 316 ϕ 5 mm	5 mm - 49 filii/wires/fils	0,098	1440



Treccia in polipropilene per ancoraggio pompa

Braided polypropylene for the anchorage for pumps
Tresse en polypropylène pour l'ancrage des pompes

Tipo Type Type	Diametro Diameter Diamètre (mm)	Bobina-Coil-Bobine		Carico di rottura Tensile strength Charge de rupture (kg)
		Lunghezza Length Longueur (mt)	Peso Weight Poids (kg)	
TR 8	8	300	15	350
TR 10	10	200	15	550
TR 12	12	200	20	800
TR 14	14	100	15	1100
TR 16	16	100	20	1400
TR 18	18	100	22	1800



Accessori per ancoraggio pompa

Accessories for the anchorage of the pump
Accessoires pour l'ancrage de la pompe

Tipo Type Type	Descrizione Description Description	Diametro Diameter Diamètre
F5	Morsetti - Clips - Bornes AISI 316 ϕ 5 mm	per fune da 5 mm - 5 mm rope - pour cordage 5 mm
M5	Moschettone - Carabiner - Mousqueton AISI 316	5 mm
M6	Moschettone - Carabiner - Mousqueton AISI 316	6 mm
M7	Moschettone - Carabiner - Mousqueton AISI 316	7 mm
M8	Moschettone - Carabiner - Mousqueton AISI 316	8 mm
G6	Grilletto - Shackle - Chaînes AISI 316	6 mm
G8	Grilletto - Shackle - Chaînes AISI 316	8 mm
G10	Grilletto - Shackle - Chaînes AISI 316	10 mm



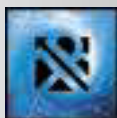

Riduzioni per corpi pompa in acciaio inox AISI 316

AISI 316 stainless steel reductions for pumps

Réductions en acier inoxydable AISI 316 pour le pompes

Tipo Type Type	Diametro (mm) Diameter (mm) Diamètre (mm)
RMF 1"¼ x 1"	1"¼ - 1"
RMF 1"½ x 1"¼	1"½ - 1"¼
RMF 2" x 1"¼	2" - 1"¼
RMF 2" x 1"½	2" - 1"½
RMF 2"½ x 1"½	2"½ - 1"½
RMF 2"½ x 2"	2"½ - 2"
RMF 3" x 2"	3" - 2"
RMF 3" x 2"½	3" - 2"½



Flange in acciaio inox AISI 304 per corpi pompa F.B.

AISI 304 Stainless steel flanges for F.B. pumps

Flange en acier inoxydable AISI 304

Tipo Type Type	Diametro (mm) Diameter (mm) Diamètre (mm)
FB6S 3	146 x 3"
FB8S 5	198 x 5"
FB10S 5	240 x 5"
FB10S 6	240 x 6"
FB10R 4	220 x 4"
FB12S 6	290 x 6"
FB12S 7	290 x 7"



Il kit è composto da flangia, guarnizioni e viteria

Kit is composed of flange, gasket and screws

Le kit est composé par: flange, joint et vis

ANODO SACRIFICIALE

È consigliabile l'utilizzo quando si è in presenza di impianti con diversi tipologie di materiali, in prossimità di linee ferroviarie e linee elettriche. Con la sua facilità di inserimento nella parte inferiore del motore, lo protegge dalla corrosione da pitting ed in presenza di correnti galvaniche.



SACRIFICIAL ANODE

It is recommended to use it when different materials are coupled together in the same installation, next to railway lines or electric lines.

The correct installation is in the bottom part of the motor, so it protects the motor from pitting corrosion and galvanic current.



ANODE SACRIFICIELLE

On recommande l'utilisation de l'anode quand il y a différents types de matériels dans la même installation, en proximité de la ligne de chemin de fer et de la ligne électrique. Il est très simple à installer dans la partie inférieure du moteur, il protège le moteur contre la corrosion de type pitting et les courants galvaniques.

Tipo Type Type	Applicazione Use Application
ANODO 4B	Motori 4B - 4B motors - Moteur 4B





AVVIAMENTO DIRETTO

DIRECT STARTING

DÉMARRAGE DIRECT

Potenza Power Puissance		Sezione cavi 4 x ... mm ² Section of the cables 4 x ... mm ² - Section des câbles 4 x ... mm ²						
		1,5	2,5	4	6	10	16	25
Cv Hp	Kw	Massima lunghezza del cavo in metri Maximum length of the cables in meters Longueur maximale des câbles en mètres						
0,5	0,37	91	151	241	362			
0,75	0,55	72	121	193	290	483		
1	0,75	52	86	138	207	345		
1,5	1,1	36	60	97	145	241	340	
2	1,5	30	50	80	121	201	298	
3	2,2		37	60	90	151	230	398

Le lunghezze dei cavi sono riferite ad una temperatura ambiente di 30°C; installazione in aria, cosφ=0,8 e caduta di tensione ammessa=3%

The lengths of the cables refer to an environmental temperature of 30°C; in air, cosφ = 0,8, voltage drop allowed = 3%

Les longueurs des câbles se réfèrent à une température ambiante de 30°C; en air, cosφ = 0,8, chute de tension admise = 3%

SCHEMA DI COLLEGAMENTO PER MOTORI MONOFASE

SINGLE-PHASE MOTORS WIRING DIAGRAM

SCHÉMA DE CONNEXION POUR MOTEURS MONOPHASÉ

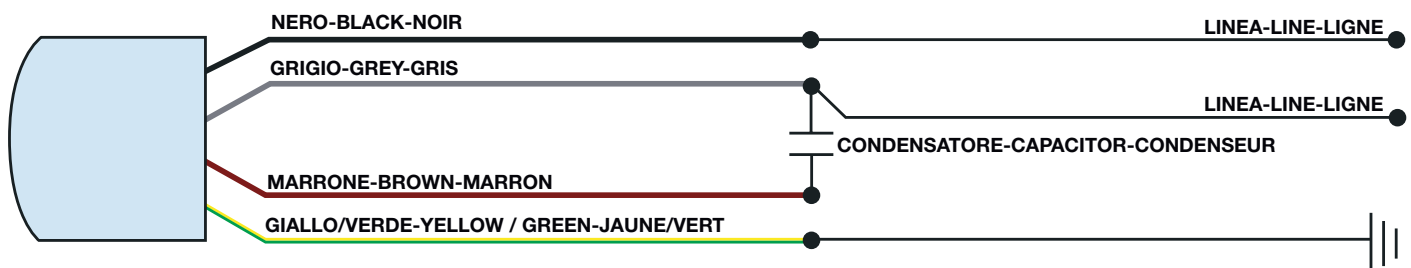

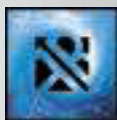

AVVIAMENTO DIRETTO O STATORICO

DIRECT OR STATORIC STARTING

DÉMARRAGE DIRECT OU STATORIQUE

Potenza Power Puissance		N° 1 Cavo - Sezione 4 x ... mm ² N° 1 Cable - Section 4 x ... mm ² N° 1 Câble - Section 4 x ... mm ²										N° 3 Cavi Unipolari - Sezione 1 x ... mm ² N° 3 Single-wire cables - Section 1 x ... mm ² N° 3 Câbles Unipolaires - Section 1 x ... mm ²						
		1,5	2,5	4	6	10	16	25	35	50	70	25	35	50	70	95	120	150
Cv Hp	Kw	Massima lunghezza del cavo in metri Maximum length of the cables in meters Longueur maximale des câbles en mètres										Massima lunghezza del cavo in metri Maximum length of the cables in meters Longueur maximale des câbles en mètres						
0,5	0,37	181	302															
0,75	0,55	155	258	412														
1	0,75	126	211	337	506													
1,5	1,1	85	142	227	341	568												
2	1,5	68	114	182	274	456												
3	2,2	46	76	122	183	306	489											
4	3	34	56	90	135	224	359	561										
5,5	4			70	104	174	278	435										
7,5	5,5			52	78	129	207	324	453									
10	7,5			38	57	94	151	236	330	472								
12,5	9,2			31	46	77	124	193	270	386	541	161	225	322	451			
15	11				39	65	105	164	229	327	458	136	191	273	382	518		
17,5	13				33	55	87	136	191	273	382	114	159	227	318	432		
20	15					46	74	116	162	232	325	97	135	193	270	367	464	
25	18,5					40	64	100	140	200	280	83	117	167	234	317	400	
30	22						54	84	117	168	235	70	98	140	196	265	335	419
35	26						47	73	103	146	205	61	85	122	171	232	293	366
40	30							62	86	123	172	51	72	103	144	195	246	308
50	37							50	70	100	141	42	59	84	117	159	201	251
60	45								58	83	117	35	49	69	97	132	167	208
70	51								53	76	106		44	63	89	120	152	190
75	55								49	71	99		41	59	82	112	141	177
80	59									71	99		40	57	79	107	136	170
85	62									63	88			52	73	99	125	157
90	66									60	85			50	71	96	121	151
100	75									52	73				61	82	104	130
125	92									42	59	78			49	67	85	106
150	110									37	51					58	73	92
180	132										44					50	63	79
200	150																55	69
230	170																49	61
260	190																43	54

Le lunghezze dei cavi sono riferite ad una temperatura ambiente di 30°C; installazione in aria, cosφ=0,8 e caduta di tensione ammessa=3%

The lengths of the cables refer to an environmental temperature of 30°C; in air, cosφ = 0,8, voltage drop allowed = 3%



AVVIAMENTO DIRETTO O STATORICO

DIRECT OR STATORIC STARTING

DÉMARRAGE DIRECT OU STATORIQUE

Potenza Power Puissance		N° 1 Cavo - Sezione 4 x ... mm ² N° 1 Cable - Section 4 x ... mm ² N° 1 Câble - Section 4 x ... mm ²										N° 3 Cavi Unipolari - Sezione 1 x ... mm ² N° 3 Single-wire cables - Section 1 x ... mm ² N° 3 Câbles Unipolaires - Section 1 x ... mm ²						
		1,5	2,5	4	6	10	16	25	35	50	70	25	35	50	70	95	120	150
Cv Hp	Kw	Massima lunghezza del cavo in metri Maximum length of the cables in meters Longueur maximale des câbles en mètres										Massima lunghezza del cavo in metri Maximum length of the cables in meters Longueur maximale des câbles en mètres						
0,5	0,37	454																
0,75	0,55	346	576															
1	0,75	302	504	806														
1,5	1,1	227	378	605														
2	1,5	165	242	388	581													
3	2,2	123	205	328	492													
4	3	89	148	236	354	590												
5,5	4			204	306	509												
7,5	5,5			155	232	387	619											
10	7,5			114	171	285	455											
12,5	9,2			90	135	225	360					469						
15	11			79	118	197	316	494				411	576					
17,5	13			67	100	167	267	417				348	487					
20	15			57	85	142	228	356	498			296	415	593				
25	18,5				73	121	194	302	423			252	353	504	706			
30	22				60	101	161	252	353	504		210	294	420	588	798		
35	26					88	141	220	308	440		183	257	367	513	696	880	
40	30					74	118	185	259	369	517	154	215	308	431	585	739	923
50	37						103	161	226	323	452	134	188	269	376	511	645	806
60	45						87	135	189	270	378	113	158	225	315	428	541	676
70	51							114	160	228	320	95	133	190	266	361	456	571
75	55							106	149	212	297	88	124	177	248	336	424	531
80	59							103	144	205	287	85	120	171	239	325	410	513
85	62							95	132	189	265	79	110	158	221	299	378	473
90	66								127	182	255	76	106	152	212	288	364	455
100	75								109	156	219		91	130	182	247	312	390
125	92									127	178	78		106	149	202	255	318
150	110									110	154				128	174	220	275
180	132									95	133				111	150	190	237
200	150										117				97	132	167	209
230	170														86	116	147	183
260	190															102	129	161

Le lunghezze dei cavi sono riferite ad una temperatura ambiente di 30°C; installazione in aria, cosφ=0,8 e caduta di tensione ammessa=3%

The lengths of the cables refer to an environmental temperature of 30°C; in air, cosφ = 0,8, voltage drop allowed = 3%

Les longueurs des câbles se réfèrent à une température ambiante de 30°C; en air, cosφ = 0,8, chute de tension admise = 3%

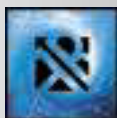

AVVIAMENTO STELLA - TRIANGOLO

STAR - DELTA STARTING

DÉMARRAGE ÉTOILE - TRIANGLE

Potenza Power Puissance		N° 2 Cavi - Sezione 4 x ... mm ² N° 2 Cables - Section 4 x ... mm ² N° 2 Câbles - Section 4 x ... mm ²									N° 6 Cavi Unipolari - Sezione 1 x ... mm ² N° 6 Single-wire cables - Section 1 x ... mm ² N° 6 Câbles Unipolaires - Section 1 x ... mm ²						
		2,5	4	6	10	16	25	35	50	70	25	35	50	70	95	120	150
Cv Hp	Kw	Massima lunghezza del cavo in metri Maximum length of the cables in meters Longueur maximale des câbles en mètres									Massima lunghezza del cavo in metri Maximum length of the cables in meters Longueur maximale des câbles en mètres						
10	7,5		168	252	420												
12,5	9,2		133	199	332												
15	11		117	175	292	466											
17,5	13		99	148	246	394											
20	15		84	126	210	336	525				438						
25	18,5		71	107	179	286	446				372	521					
30	22		60	89	149	238	372	521			310	434					
35	26		52	78	130	208	325	455			271	379	541				
40	30		44	65	109	174	273	382			227	318	454	636			
50	37			57	89	143	223	312	445		198	278	397	556	754		
60	45			48	80	128	200	279	399	559	166	233	333	466	632	798	998
70	51				67	108	168	236	337	472	140	197	281	393	533	674	842
75	55				63	100	157	219	313	439	131	183	261	365	496	627	783
80	59				61	97	151	212	303	424	126	177	252	353	479	605	757
85	62					89	140	195	279	391	116	163	233	326	442	558	698
90	66					86	134	188	269	376	112	157	224	313	425	537	671
100	75					74	115	161	230	323	96	134	192	269	365	461	576
125	92						94	132	188	263	78	110	157	219	298	376	470
150	110						81	114	162	227	68	95	135	189	257	325	406
180	132							98	140	196		82	117	163	222	280	350
200	150							86	123	172		72	103	144	195	246	308
230	170								108	152			90	126	171	216	271
260	190								95	133			79	111	151	190	238

Le lunghezze dei cavi sono riferite ad una temperatura ambiente di 30°C; installazione in aria, cosφ=0,8 e caduta di tensione ammessa=3%

The lengths of the cables refer to an environmental temperature of 30°C; in air, cosφ = 0,8, voltage drop allowed = 3%

Les longueurs des câbles se réfèrent à une température ambiante de 30°C; en air, cosφ = 0,8, chute de tension admise = 3%

SCelta DEL GENERATORE

GENERATOR SELECTION

CHOIX DU GÉNÉRATEUR

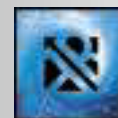

Potenza motore elettrico Electric motor power Puissance moteur électrique		Potenza del generatore - Generator power - Puissance du générateur			
		Avviamento diretto - Direct starting - Démarrage direct		Avviamento stella-triangolo - Star-delta starting - Démarrage étoile-triangle	
HP	kW	kW	kVA	kW	kVA
3	2,2	7,6	9,5	6,5	8
4	3	10,8	13,5	9	11
5,5	4	12	15	10	12,5
7,5	5,5	15,6	20	13	16,5
10	7,5	21,2	27	17,5	22
12,5	9,2	26,8	34	22,5	28
15	11	31	38	26	32
17,5	13	36	45	30	38
20	15	43	53	35	44
25	18,5	50	63	42	52
30	22	60	75	50	63
35	26	69	86	57	72
40	30	80	100	68	85
50	37	100	125	85	105
60	45	120	150	100	125
70	51	135	170	110	140
75	55	145	180	120	150
80	59	150	185	125	155
85	62	160	200	135	170
90	66	170	210	140	175
100	75	190	240	160	200
125	92	240	300	200	250
150	110	275	345	230	285
180	132	320	400	265	330
200	150	360	450	305	380
230	170	410	515	345	430
260	190	470	585	390	490

* Tabella indicativa

* Approximate chart

* Table approximative



TABELLA PERDITE DI CARICO NELLE TUBAZIONI

HEAD LOSS IN PIPES CHART

TABLEAU PERTES DE CHARGE DANS LES TUYAUX

DN		Q = Portata - Capacity - Débit																						
		0,2	0,3	0,5	0,7	1,0	1,3	1,7	2,1	2,5	2,9	3,3	4,2	5	6,7	8,3	10	12,5	17	21	25	29	33	42
l/sec		0,94	1,89	2,83																				
l/min		2,6	9,4	20	35	74																		
mc/h		0,53	1,06	1,59	2,12	3,18																		
mm		10	20	30	40	60	80	100	125	150	175	200	250	300	400	500	600	750	1000	1250	1500	1750	2000	2500
inc		0,6	1,2	1,8	2,4	4	4,8	6	7,5	9	11	12	15	18	24	30	36	45	60	75	90	105	120	150
15	1/2"	11	40	85																				
20	3/4"	2,6	9,4	20	35	74																		
25	1"	0,8	3,1	6,6	11	24	41	63	95															
32	1 1/4"	0,9	1,9	3,3	7,0	12	18	28	39	52	66													
40	1 1/2"	0,41	0,62	0,83	1,24	1,66	2,07	2,59	3,11	3,63	4,14													
50	2"	0,3	0,6	1,1	2,3	3,9	5,9	9,0	13	17	22	33	46	79										
65	2 1/2"	0,27	0,40	0,53	0,80	1,06	1,33	1,66	1,99	2,32	2,65	3,32	3,98	5,31										
80	3"				0,4	0,7	1,3	1,9	3,0	4,2	5,5	7,1	11	15	26	39	55	84						
					0,34	0,51	0,68	0,85	1,06	1,27	1,49	1,70	2,12	2,55	3,40	4,24	5,09	6,37						
					0,2	0,3	0,5	0,8	1,1	1,5	1,9	2,9	4,1	7,0	11	15	23	39	59	83				
					0,30	0,40	0,50	0,63	0,75	0,88	1,00	1,26	1,51	2,01	2,51	3,01	3,77	5,02	6,28	7,53				
									0,4	0,5	0,7	1,0	1,4	2,5	3,7	5,3	8,0	14	21	29	39	50	76	
									0,50	0,58	0,66	0,83	0,99	1,33	1,66	1,99	2,49	3,32	4,14	4,97	5,80	6,63	8,29	

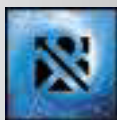
HI = Perdite di carico in metri per 100 m di tubazione orizzontale

Head loss in meters for each 100 m of horizontal pipe

Pertes de charge par 100 mètres de tuyau horizontal

v = Velocità - Speed - Vitesse (m/s)

* I dati in tabella sono indicativi per tubazioni in ghisa

* The data in the sheet are indicative for cast-iron pipes

* Les données des tableaux sont indicatives pour les tuyaux en fonte

Moltiplicare: 0,8 per tubi in acciaio ; 0,75 per tubi in PE-PVC; 1,2 per tubi vecchi o con incrostazioni evidenti

Multiply: 0,8 for steel pipes; 0,75 for PE-PVC pipes; 1,2 for old pipes or encrusted pipes

Multiplier: 0,8 pour tuyaux en acier; 0,75 pour tuyaux en PE-PVC; 1,2 pour vieux tuyaux ou incrustés

TABELLA PERDITE DI CARICO NELLE TUBAZIONI

HEAD LOSS IN PIPES CHART

TABLEAU PERTES DE CHARGE DANS LES TUYAUX

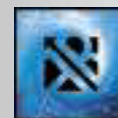

DN		Q = Portata - Capacity - Débit																							
		3,3	4,2	5	6,7	8,3	10	12,5	15	17	21	25	29	33	42	50	60	67	83	100	117	133	167	200	250
l/sec		0,22	0,3	0,5	0,8	1,2	1,7	2,6	4,5	6,8	9,5	13	16	25	35	60									
l/min		0,42	0,53	0,64	0,85	1,06	1,27	1,59	2,12	2,65	3,18	3,71	4,24	5,31	6,37	8,49									
mc/h		12	15	18	24	30	36	45	60	75	90	105	120	150	180	240	300	360	420	480	550	600	720	900	
100	4"																								
125	5"					0,4	0,6	0,9	1,5	2,2	3,1	4,2	5,3	8,1	11	20	30	42	56	71	86				
150	6"					0,68	0,81	1,02	1,36	1,70	2,04	2,38	2,72	3,40	4,07	5,43	6,79	8,15	9,51	10,86					
175	7"							0,3	0,6	0,9	1,3	1,7	2,1	3,3	4,6	7,8	12	17	22	29	36	43	61	93	
200	8"					0,71	0,94	1,18	1,41	1,65	1,89	2,12	2,36	2,83	3,77	4,72	5,66	6,60	7,55	8,49	9,43	11,32	14,15		
250	10"							0,4	0,6	0,8	1,0	1,5	2,1	3,6	5,5	7,7	10	13	17	22	28	34	47	7,2	
300	12"							0,87	1,04	1,21	1,39	1,73	2,08	2,77	3,46	4,16	4,85	5,54	6,23	6,92	7,61	8,30	10,39		
350	14"									0,3	0,4	0,5	0,8	1,1	1,9	2,8	4,0	5,3	6,8	8,3	9,8	11,3	14,1	22	
400	16"									0,80	0,93	1,06	1,33	1,59	2,12	2,65	3,18	3,71	4,24	4,77	5,30	5,83	7,36	7,96	
														0,4	0,6	0,9	1,3	1,7	2,2	2,7	3,2	3,7	4,7	7,2	
														1,02	1,36	1,70	2,04	2,38	2,72	3,06	3,40	4,07	5,09	2,9	
																1,18	1,41	1,65	1,89	2,13	2,36	2,83	3,54		
																		0,3	0,4	0,6	0,9	1,3	1,9	2,9	
																		1,21	1,39	1,73	2,08	2,60	3,20	4,07	
																			0,2	0,3	0,4	0,6	0,9	1,3	
																			1,06	1,33	1,59	1,99	2,60	3,30	

HI = Perdite di carico in metri per 100 m di tubazione orizzontale **Moltiplicare:** 0,8 per tubi in acciaio ; 0,75 per tubi in PE-PVC; 1,2 per tubi vecchi o con incrostazioni evidenti

Head loss in meters for each 100 m of horizontal pipe Multiply: 0,8 for steel pipes; 0,75 for PE-PVC pipes; 1,2 for old pipes or encrusted pipes

Pertes de charge par 100 mètres de tuyau horizontal Multiplier: 0,8 pour tuyaux en acier; 0,75 pour tuyaux en PE-PVC; 1,2 pour vieux tuyaux ou incrustés

v = Velocità - Speed - Vitesse (m/s)

* I dati in tabella sono indicativi per tubazioni in ghisa

* The data in the sheet are indicative for cast-iron pipes

* Les données des tableaux sont indicatives pour tuyaux en fonte

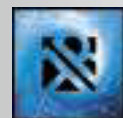

WWW.FBPOMPE.COM



F.B.
SUBMERSIBLE MOTORS

F.B. Srl
Via Valchiampo, 68
36050 Montorso Vicentino (VICENZA) - ITALY
Tel. +39 0444 451330 - Fax +39 0444 478362
E-mail: info@fbpompe.com
www.fbpompe.com



SUBMERSIBLE MOTORS

